

# TOSHIBA

DYSTRYBUTOR:

**TK THERMO  
KOMFORT**

Systemy HVACR

[www.thermokomfort.pl](http://www.thermokomfort.pl)

tel. 505 034 537

e-mail: [biuro@thermokomfort.pl](mailto:biuro@thermokomfort.pl)

EXPERIENCE  
THE FUTURE





# > FOR A MORE INSPIRING WORLD



## > A range in line with our environmental vision

Toshiba is offering a complete range of air-to-air products dedicated to cooling and heating in comfort applications. With individual system solutions from 2 to 28kW, we are able to address residential and light commercial markets requirements.

### Residential

HAORI is a truly elegant air conditioner, featuring a stylish textile fabric cover that uses Toshiba inverter and compressor technology with R32, offering A+++ performance and year-round comfort.

### Light commercial

A full range of Toshiba R32 light commercial systems is available on the European market including a R32 Super Digital Inverter with best in class efficiency.

### Business

After the switch to low GWP refrigerant for its residential and light commercial products, Toshiba is now one of the first to launch a top blow VRF using R32: The SHRM Advance. Give a new environmental dimension to your projects.



**RESIDENTIAL**  
AIR TO AIR  
SPLIT

P.6



**RESIDENTIAL**  
AIR TO AIR  
MULTISPLIT

P.20



**LIGHT  
COMMERCIAL**

P.50



**CONTROLS**

P.92



RESIDENTIAL AIR TO AIR SPLIT

RESIDENTIAL AIR TO AIR MULTI

LIGHT COMMERCIAL

CONTROLS



## > NEW AIR-TO-AIR SYSTEM



The new R32 Multisplit System features 3 highly efficient and low-noise outdoor units to cover heating and cooling capacities from 3kW to 14kW for SEER of up to 8.70 and SCOP to 4.80.

- 2M10 & 2M14 A+++/A++
- 2M18 & 3M18 A+++/A++
- 3M26, 4M27 & 5M34 A++/A++

Whatever the type of dwelling, the new SHORAI™ Edge will enhance any interior space with its clean lines and smooth finish. Whether the desired look is classy, trendy or contemporary, those targeting inner beauty shall turn to SHORAI Edge. Toshiba Air Conditioning has created a winning alliance between new design attractiveness and A+++ class-leading energy performance.

## > NEW AIR-TO-WATER SYSTEM

The newly expanded ESTIA™ R32 air-to-water heat pump series offers A+++ energy efficiency (SCOP up to 4.65 and COP up to 5.20) to lower energy bills.

To complement the highly successful range of single-phase ESTIA R32 outdoor units already available (4, 6, 8, 11, 14kW), Toshiba Air Conditioning is adding a trio of high-performance three-phase models to the line-up, offering power capacities of 8, 11 and 14kW.

**TOSHIBA**

**ESTIA**

DESIGNED IN JAPAN  
MADE IN EUROPE



Residential Heating > Air to water heat pump

Also introduced is an upgraded all-in-one (AIO) hydro unit for space heating and DHW production. The new AIO unit is 26% lighter than the legacy model and features a more compact footprint (now only 595 x 670mm). A new stainless-steel cylinder allows a DHW water pressure up to 10 bars.



**NEW LIGHT COMMERCIAL PRODUCTS**



**Push boundaries**



Digital Inverter

The installer-friendly technology to maximize project coverage and save time at the installation, commissioning and maintenance phases.

**Black elegance**

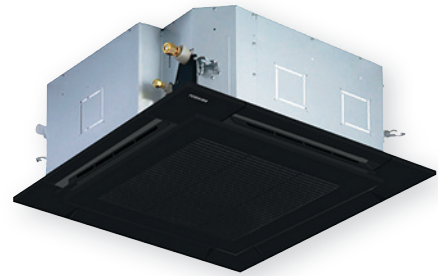

Standard 4-Way Cassette

Experience the timeless black panel elegance of the Standard 4-Way Cassette.

**NEW BUSINESS PRODUCTS**

**Contribute to decarbonization**



MiNi-SMMS™

The new R32 MiNi-SMMS combines high efficiency, strong flexibility and advanced connectivity.

**A great ally**



Haori™

The residential Haori high wall is now compatible with all VRF outdoor units, enjoy the alliance of design and efficiency.

**NEW CONTROL PRODUCTS**

**Keep connected**



RBC-AWSU52-E

Enjoy a greater control experience with the new wired remote controller RBC-AWSU52-E also featuring an embedded Bluetooth® module.

**So many attractive qualities**



YHP Cassette

Only 150mm in height chassis, low sound level, intelligent occupancy sensor, advanced air filtration solutions and more.



# ON YOUR OWN AS A FAMILY IN A GROUP ON YOUR OWN



In 1981, Toshiba was the first company to incorporate inverter technology into air conditioning systems. Ever since, it has retained its technological advantage over its competitors. Its development of the new and exclusive DC hybrid inverter system has reaffirmed its ability to innovate and remain a technological leader, even in fast-growing markets. But for Toshiba, innovation also involves working alongside international institutions that carefully evaluate the impact of new technologies on our environment. Toshiba combines technological development with concern for future generations, resulting in a range of extremely energy-efficient air conditioners, which reduce greenhouse gas emissions at the source. Toshiba's continuous research led to the development of PWM (Pulse Width Modulation) technology, which is used in combination with traditional PAM (Pulse Amplitude Modulation) control. The application of these two distinct technologies enables total control of performance and energy use.





RESIDENTIAL  
AIR-TO-AIR  
SPLIT

AS A FAMILY IN A GROUP ON YOUR OWN AS A FAMILY

# > HIGH WALLS & CONSOLES



## When technology meets comfort

### > Innovation, efficiency, high reliability, energy savings, environmental respect ...

These are the powerful values at the heart of Toshiba's DNA. For over 50 years Toshiba has been providing its clients with the guaranteed accuracy and expertise of flawless Japanese quality. Technological, stylish, highly efficient and environmentally-friendly, the Toshiba monosplit units proudly uphold the values rooted firmly in its name.

### > The development of the new and exclusive DC hybrid inverter system

has reaffirmed this ability to innovate and maintain technological leadership in a fast-growing market. But for Toshiba, innovation also means a strong commitment to international institutions that carefully evaluate the impact of new technologies on our environment. Toshiba combines technological development with care for future generations: the result is a range of extremely energy-efficient air conditioners, reducing greenhouse gas emissions at source.

Toshiba continuous research into the development of PWM technology, which together with the traditional PAM control, allows total control of the systems performance and energy usage.

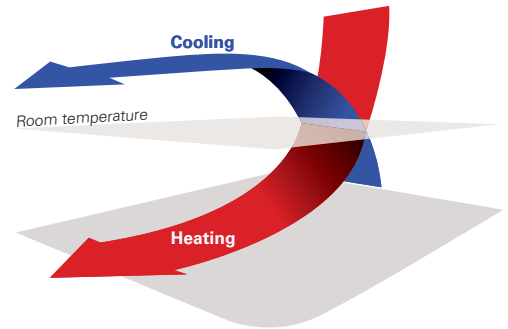

The new Hybrid Inverter features PAM (Pulse Amplitude Modulation) for the highest levels of power.



PWM (Pulse With Modulation) for energy efficiency.

## The Future Is Now

### > Energy efficiency by design

Toshiba products are designed to optimise energy performance at any time of year. This in turn reduces the amount of indirect CO<sub>2</sub> emissions generated by the electricity consumption.

### > Lowest level refrigerant charge

Toshiba is committed to minimising the refrigerant charge of its products and has made this a key performance indicator for all new product developments.

### > European F-GAS regulation

R32 is today the right alternative to R410A. The European F-gas regulation (517/2014) has been in force since 1 January 2015 and will progressively phase down the use of hydrofluorocarbons (HFCs) in the heating and cooling systems of the future. Toshiba already offers new heating and cooling systems operating with R32, which will be the alternative to R410A in the years ahead. The new R32 refrigerant ensures an ideal balance between energy-efficiency and respect for the environment. The quantities of HFCs that are placed on the market will be gradually reduced in a step-by-step approach, until they finally reach a minimum level by 2030.



HFC consumption related to tons of CO<sub>2</sub> equivalent







**ADVANCED TECHNOLOGY AVAILABLE WITH R32 REFRIGERANT**

RESIDENTIAL AIR-TO-AIR



DAISEIKAI 9



HAORI



SHORAI EDGE  
Black or White



SEIYA



CONSOLE

**Toshiba Home AC Control**

Take complete control of your comfort with the Toshiba Home AC Control App. Simple to use on your smartphone or tablet, both at home and on the move. Fully compatible, the adapter can be used with all Toshiba High-wall and Console units.



RAS-B-N4KVRG-E  
**HAORI**



HAORI, the air conditioner that respects your universe with a truly elegant design, featuring a stylish textile fabric cover. Innovation, efficiency, high reliability, energy savings, respect for the environment: these powerful values are at the heart of everything we do at Toshiba. HAORI offers energy efficient A+++ cooling and heating performances, with R32 refrigerant.

**Truly elegant design** featuring a stylish textile fabric cover.

**High energy class A+++ / A+++**

- Heating and cooling modes ensure exceptional energy savings and unparalleled comfort levels.

**Ultra-quiet system**

- HAORI Silent function halves the sound level of the outdoor unit down to 37 dB(A), while its Quiet function reduces noise from the indoor unit to less than 19 dB(A) for a good night's sleep.

**Indoor Air Quality**

- The new Toshiba Ultra Pure Filter captures up to 94% of PM2.5 (particulate matters coming from atmospheric pollution), creating healthy living spaces at home.
- Toshiba Plasma Ionizer, catches & neutralizes the contaminated particles.
- HAORI is equipped with the Magic Coil® which helps prevent water and dust from sticking to the coil.



MAX EFFICIENCY



SEER 8.7  
SCOP 5.1

CAPACITY



2.5kW > 4.6kW

OPERATION



-15°C > +46°C

- > **Silent modes** with indoor unit Quiet mode & Silent outdoor unit function
- > **Toshiba HAORI luxury remote control** features a magnetic wall mounted holder
- > **Intuitive remote-control functions** with Power select and ECO modes to reduce energy bills, Hi-power for rapid cooling or heating
- > **Enhance your comfort at home or away** with Toshiba Home AC app
- > **HAORI features** energy monitoring and speaker voice control functions compatible with Google Home Assistant & Amazon Alexa.

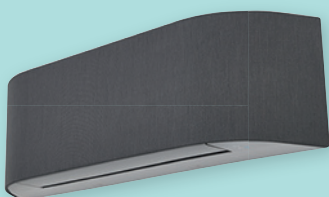

**INDOOR UNITS**

RAS-B10N4KVRG-E  
RAS-B13N4KVRG-E  
RAS-B16N4KVRG-E



**OUTDOOR UNITS**

RAS-10J2AVSG-E1  
RAS-13J2AVSG-E1  
RAS-16J2AVSG-E1



**REMOTE CONTROLS**

Delivered with the unit



### HAORI Performance data

Outdoor unit			RAS-10J2AVSG-E1	RAS-13J2AVSG-E1	RAS-16J2AVSG-E1
Indoor unit			RAS-B10N4KVRG-E	RAS-B13N4KVRG-E	RAS-B16N4KVRG-E
<b>Cooling capacity</b>	<b>kW</b>		<b>2.5</b>	<b>3.5</b>	<b>4.6</b>
Cooling range (min. - max.)	kW		(0.89 - 3.20)	(1.00 - 4.10)	(1.20 - 5.30)
Power input (min. -rated - max.)	kW	C	(0.19 - 0.54 - 0.79)	(0.25 - 0.80 - 1.12)	(0.34 - 1.35 - 1.72)
Pdesignc	kW		2.5	3.5	4.6
EER	W/W		4.63	4.38	3.41
SEER			8.60	8.70	7.80
Energy efficiency class		C	A+++	A+++	A++
Seasonal electricity consumption	kWh/a	C	102	142	206
<b>Heating capacity</b>	<b>kW</b>		<b>3.2</b>	<b>4.2</b>	<b>5.5</b>
Heating range (min. - max.)	kW		(0.90 - 4.70)	(1.00 - 5.30)	(1.10 - 6.30)
Power input (min. -rated - max.)	kW	H	(0.18 - 0.74 - 1.23)	(0.20 - 1.08 - 1.55)	(0.30 - 1.52 - 1.90)
Pdesignh	kW		2.5	3.2	4.00
COP	W/W		4.32	3.89	3.62
SCOP			5.10	5.10	4.60
Energy efficiency class		H	A+++	A+++	A++
Seasonal electricity consumption	kWh/a	H	684	876	1214

### HAORI Physical data indoor

Indoor unit			RAS-B10N4KVRG-E	RAS-B13N4KVRG-E	RAS-B16N4KVRG-E
Air flow (h)	m <sup>3</sup> /h - l/s	C	600 - 166	670 - 186	690 - 180
Air flow (l)	m <sup>3</sup> /h - l/s	C	300 - 83	320 - 89	340 - 83
Sound pressure level (h/q)	dB(A)	C	41/19	43/19	45/21
Sound power level (h)	dB(A)	C	54	56	58
Air flow (h)	m <sup>3</sup> /h - l/s	H	610 - 169	680 - 189	730 - 186
Air flow (l)	m <sup>3</sup> /h - l/s	H	300 - 86	320 - 89	360 - 83
Sound pressure level (h/q)	dB(A)	H	41/19	43/19	45/22
Sound power level (h)	dB(A)	H	54	56	58
Dimensions (hxwxh)	mm		300 x 987 x 210	300 x 987 x 210	300 x 987 x 210
Weight	kg		11	11	12
Remote controller			WH-UA01UE	WH-UA01UE	WH-UA01UE

### HAORI Physical data outdoor

Outdoor unit			RAS-10J2AVSG-E1	RAS-13J2AVSG-E1	RAS-16J2AVSG-E1
Air flow (max)	m <sup>3</sup> /h - l/s	C	1890 - 524	1950 - 540	2040 - 566
Sound pressure level (h)	dB(A)	C	44	46	48
Sound pressure level (Silent CDU#2)	dB(A)	C	37	39	40
Sound power level (h)	dB(A)	C	57	59	61
Sound power level ((Silent CDU#2)	dB(A)	C	50	52	53
Operating range	°C	C	-15 ~ 46	-15 ~ 46	-15 ~ 46
Air flow (max)	m <sup>3</sup> /h - l/s	H	1890 - 524	1950 - 540	2040 - 566
Sound pressure level (h)	dB(A)	H	46	48	50
Sound pressure level (Silent CDU#2)	dB(A)	H	39	43	43
Sound power level (h)	dB(A)	H	59	61	63
Sound power level ((Silent CDU#2)	dB(A)	H	52	56	56
Operating range	°C	H	-15 ~ 24	-15 ~ 24	-15 ~ 24
Dimensions (hxwxh)	mm		550 x 780 x 290	550 x 780 x 290	550 x 780 x 290
Weight	kg		26	30	33
Compressor type			DC Rotary	DC Rotary	DC Rotary
Flare connections (gas-liquid)			3/8" - 1/4"	3/8" - 1/4"	1/2" - 1/4"
Minimum pipe length	m		2	2	2
Maximum pipe length	m		20	20	20
Maximum height difference	m		12	12	12
Chargeless pipe length	m		15	15	15
Refrigerant charging (R32)	kg		0.55	0.8	0.8
Power supply	V-ph-Hz		230-1-50	230-1-50	230-1-50

C: cooling mode  
H: heating mode

RAS- PKVPG-E  
**DAISEIKAI 9**



The exclusive New Daiseikai 9 is the market benchmark for high efficiency solution. Its new elegant design and higher standards in efficiency and comfort, maximize energy savings, and offer exceptional indoor air quality thanks to its exclusive filtration system.

**High Energy Class A+++ / A+++**

- Very high energy efficiency class, both in cooling and heating.
- Very low energy consumption in all conditions.
- Wide operating range.

**Extremely silent**

- Less than 20dB(A) in silent mode.

**Indoor air quality with double filtration system**

- The Plasma Ion Charger filtration system associated with self-cleaning coil provides a pure and healthy environment.
- The Ionizer System provides pure air by absorbing smoke and bad odors, this function can be activated anytime by pushing the "PURE" button on remote controller.

**User friendly wireless remote control with weekly timer**

- One-Touch User Comfort parameter pre-set.
- 8°C button for anti-frost during holiday periods.
- Comfort Sleep for extra silence mode.
- 3D airflow control with vertical & horizontal motorized louvers: pre-set directions or automatic sweeping.
- Weekly timer with 4 freely programmable settings per day and 7 different programs per week.
- Capacity booster to reach comfort set point very fast.
- Outdoor unit noise reduction at night.
- Fire place mode with constant fan speed to improve comfort in all conditions.



MAX EFFICIENCY



SEER 10.5  
SCOP 5.20

CAPACITY



2.5kW > 4.5kW

OPERATION



-15°C > +46°C

> **Elegant & modern design** with discreet dimming lights changing colors with cooling and heating modes

> **100% Toshiba quality with DC Twin- Rotary inverter compressor**

> **Wifi control ready** with Wifi module accessory integrated in large High wall chassis

> **Exceptional indoor air quality** Impurities are ionized by the plasma ion charger and absorbed by heat exchanger



**INDOOR UNITS**

RAS- 10PKVPG-E  
RAS- 13PKVPG-E  
RAS- 16PKVPG-E



**OUTDOOR UNITS**

RAS- 10PAVPG-E  
RAS- 13PAVPG-E  
RAS- 16PAVPG-E



**REMOTE CONTROLS**

Delivered with the unit



**DAISEIKAI 9 Performance data**

Outdoor unit	Europe		RAS-10PAVPG-E	RAS-13PAVPG-E	RAS-16PAVPG-E
Indoor unit			RAS-10PKVPG-E	RAS-13PKVPG-E	RAS-16PKVPG-E
<b>Cooling capacity</b>	<b>kW</b>		<b>2,5</b>	<b>3,5</b>	<b>4,5</b>
Cooling range (min. - max.)	kW		(0.80 - 3.50)	(0.90 - 4.10)	(0.90 - 5.10)
Power input (min. -rated - max.)	kW	C	(0.15 - 0.45 - 0.82)	(0.18 - 0.75 - 1.00)	(0.18 - 1.08 - 1.38)
Pdesignc	kW		2.5	3.5	4.5
EER	W/W		5.56	4.67	4.17
SEER			10.6	9.5	8.50
Energy efficiency class		C	A+++	A+++	A+++
Seasonal electricity consumption	kWh/a	C	83	129	185
<b>Heating capacity</b>	<b>kW</b>		<b>3.2</b>	<b>4.0</b>	<b>4.5</b>
Heating range (min. - max.)	kW		(0.70 - 5.80)	(0.80 - 6.30)	(0.80 - 6.80)
Power input (min. -rated - max.)	kW	H	(0.15 - 0.60 - 1.55)	(0.17 - 0.80 - 2.00)	(0.17 - 1.37 - 2.05)
Pdesignh (Tbiv-10°C)	kW		3.0	3.6	4.5
COP	W/W		5.33	5.0	4.01
SCOP			5.2	5.1	4.6
Energy efficiency class		H	A+++	A+++	A++
Seasonal electricity consumption	kWh/a	H	807	988	1369

**DAISEIKAI 9 Physical data indoor**

Indoor unit	Europe		RAS-10PAVPG-E	RAS-13PAVPG-E	RAS-16PAVPG-E
Air Flow (h)	m³/h - l/s	C	690 - 188	710 - 197	730 - 203
Air Flow (l)	m³/h - l/s	C	300 - 83	300 - 83	310 - 86
Sound pressure level (h/q)	dB(A)	C	43/20	44/20	45/22
Sound power level (h)	dB(A)	C	58	59	60
Air Flow (h)	m³/h - l/s	H	720 - 200	720 - 200	740 - 206
Air Flow (l)	m³/h - l/s	H	310 - 83	310 - 86	330 - 91
Sound pressure level (h/q)	dB(A)	H	44/20	45/20	46/22
Sound power level (h)	dB(A)	H	59	60	61
Dimensions (hwxwd)	mm		293 x 851 x 270	293 x 851 x 270	293 x 851 x 270
Weight	kg		14	14	14

**DAISEIKAI 9 Physical data outdoor**

Outdoor unit	Europe		RAS-10PKVPG-E	RAS-13PKVPG-E	RAS-16PKVPG-E
Air Flow (max)	m³/h - l/s	C	2160 - 600	2160 - 600	2160 - 600
Sound pressure level (h)	dB(A)	C	46	48	49
Sound pressure level (Silent CDU#2)	dB(A)	C	43	43	44
Sound power level (h)	dB(A)	C	61	63	64
Sound power level (Silent CDU#2)	dB(A)	C	58	58	59
Operating range	°C	C	-15 ~ 46	-15 ~ 46	-15 ~ 46
Air Flow (max)	m³/h - l/s	H	2160 - 600	2160 - 600	2160 - 600
Sound pressure level (h)	dB(A)	H	47	50	50
Sound pressure level (Silent CDU#2)	dB(A)	H	42	45	45
Sound power level (h)	dB(A)	H	62	65	65
Sound power level (Silent CDU#2)	dB(A)	H	57	60	60
Operating range	°C	H	-15 ~ 24	-15 ~ 24	-15 ~ 24
Dimensions (hwxwd)	mm		630 x 800 x 300	630 x 800 x 300	630 x 800 x 300
Weight	kg		38	38	38
Compressor type			DC Twin Rotary	DC Twin Rotary	DC Twin Rotary
Flare connections (gas-liquid)			3/8" - 1/4"	3/8" - 1/4"	1/2" - 1/4"
Minimum pipe length	m		2	2	2
Maximum pipe length	m		25	25	25
Maximum height difference	m		10	10	10
Chargeless pipe length	m		15	15	15
Remote controller			WH-TA01LE	WH-TA01LE	WH-TA01LE
Refrigerant charging(R32)	kg		1,0	1,0	1,0
Power supply	V-ph-Hz		220-240/1/50	220-240/1/50	220-240/1/50

C: cooling mode  
H: heating mode

RAS-G3KVSG-E

SHORAI EDGE BLACK & WHITE- R32



SHORAI Edge, a fresh take on design and performance, benefits from Toshiba's latest innovative inverter and compressor technology. It is designed to deliver high performance, making everyday comfort a reality for all. SHORAI Edge offers energy efficient A+++ cooling and heating performances, with R32 refrigerant. Compatible with Monosplit & Multisplit outdoor units (B-codes).

**High energy class A+++ / A+++**

- Heating and cooling modes ensure exceptional energy savings and unparalleled comfort levels.

**Absolute silent operation**

- SHORAI Edge's Silent function halves the sound level of the outdoor unit, while its Quiet function reduces noise from the indoor unit for a good night's sleep.

**Indoor Air Quality**

- The new Toshiba Ultra Pure Filter captures up to 94% of PM2.5 (particulate matters coming from atmospheric pollution), creating healthy living spaces at home.
- SHORAI Edge is equipped with the Magic Coil® which helps prevent water and dust from sticking to the coil. When the air conditioning is switched off to drain the contaminated coil, the fan continues to operate to keep the coil clean and dry whilst preserving the air conditioning high energy efficiency.

**User friendly wireless remote control with weekly timer**

- HADA-CARE to set louver position to generate indirect air flow for better air distribution to homogenize room temperature.
- Quiet mode for Comfort Sleep operating indoor at the lowest noise level
- Silent CDU is Toshiba's unique noise reduction function of outdoor unit for neighborhood comfort.
- Hi Power capacity booster to reach comfort set point very fast.
- OFF timer provides a very convenient automatic programmable stop function.
- On-demand Defrost for manual defrost at any time in extreme conditions.

MAX EFFICIENCY



SEER 8.6  
SCOP 5.1

CAPACITY



2.0kW > 8.0kW

OPERATION



-15°C > +46°C

> **Modern edge design** with discreet dimming lights. Available in black or white colors.

> **100% Toshiba quality with DC rotary inverter compressor**

> **Wi-Fi control ready** with **Toshiba Home AC Control** adaptor inside FCU

> **Silent modes** with indoor unit Quiet mode & Silent outdoor unit function



INDOOR UNITS

- RAS-B07G3KVSG(B)-E
- RAS-B10G3KVSG(B)-E
- RAS-B13G3KVSG(B)-E
- RAS-B16G3KVSG(B)-E
- RAS-B18G3KVSG(B)-E
- RAS-B22G3KVSG(B)-E
- RAS-B24G3KVSG(B)-E



OUTDOOR UNITS

- RAS-07J2AVSG-E1
- RAS-10J2AVSG-E1
- RAS-13J2AVSG-E1
- RAS-16J2AVSG-E1
- RAS-18J2AVSG-E1
- RAS-22J2AVSG-E1
- RAS-24J2AVSG-E1



REMOTE CONTROLS

- Delivered with the unit
- 1- WH-UA06UE
- 2- WH-UA04UE

**SHORAI EDGE BLACK & WHITE- R32**

**SHORAI EDGE BLACK & WHITE- R32 Performance data**

Outdoor unit		RAS-07J2AVSG-E1	RAS-10J2AVSG-E1	RAS-13J2AVSG-E1	RAS-16J2AVSG-E1	RAS-18J2AVSG-E1	RAS-22J2AVSG-E1	RAS-24J2AVSG-E1
Indoor unit White		RAS-B07G3KVSG-E	RAS-B10G3KVSG-E	RAS-B13G3KVSG-E	RAS-B16G3KVSG-E	RAS-B18G3KVSG-E	RAS-B22G3KVSG-E	RAS-B24G3KVSG-E
Indoor unit Black		RAS-B07G3KVSGB-E	RAS-B10G3KVSGB-E	RAS-B13G3KVSGB-E	RAS-B16G3KVSGB-E	RAS-B18G3KVSGB-E	RAS-B22G3KVSGB-E	RAS-B24G3KVSGB-E
<b>Cooling capacity</b>	<b>kW</b>	<b>2.0</b>	<b>2.5</b>	<b>3.5</b>	<b>4.6</b>	<b>5.0</b>	<b>6.1</b>	<b>7.0</b>
Cooling range (min. - max.)	kW	(0.89 - 2.90)	(0.89 - 3.20)	(1.00 - 4.10)	(1.20 - 5.30)	(1.20 - 6.00)	(1.39 - 6.70)	(1.70 - 7.70)
Power input (min. -rated - max.)	kW C	(0.19 - 0.39 - 0.67)	(0.19 - 0.54 - 0.79)	(0.25 - 0.90 - 1.12)	(0.34 - 1.35 - 1.72)	(0.35 - 1.42 - 2.00)	(0.36 - 1.99 - 2.20)	(0.38 - 2.25 - 2.55)
Pdesignc	kW	2.0	2.5	3.5	4.6	5.0	6.1	7.0
EER	W/W	5.13	4.63	3.89	3.41	3.52	3.07	3.11
SEER		8.5	8.6	8.6	7.8	7.3	7.3	6.3
Energy efficiency class	C	A+++	A+++	A+++	A++	A++	A++	A++
Seasonal electricity consumption	kWh/a C	82	102	142	206	242	292	389
<b>Heating capacity</b>	<b>kW</b>	<b>2.5</b>	<b>3.2</b>	<b>4.2</b>	<b>5.5</b>	<b>6.0</b>	<b>7.0</b>	<b>8.0</b>
Heating range (min. - max.)	kW	(0.90 - 3.60)	(0.90 - 4.80)	(1.00 - 5.30)	(1.10 - 6.50)	(1.10 - 6.50)	(1.15 - 7.50)	(1.70 - 8.80)
Power input (min. -rated - max.)	kW H	(0.16 - 0.50 - 0.80)	(0.16 - 0.70 - 1.23)	(0.20 - 1.08 - 1.55)	(0.24 - 1.52 - 1.90)	(0.25 - 1.59 - 1.75)	(0.26 - 1.88 - 2.10)	(0.29 - 2.35 - 2.75)
Pdesignh	kW	2.3	2.5	3.2	4.00	4.3	4.7	6.3
COP	W/W	5.00	4.57	3.89	3.62	3.77	3.72	3.40
SCOP		5.1	5.1	5.1	4.6	4.6	4.6	4.1
Energy efficiency class	H	A+++	A+++	A+++	A++	A++	A++	A+
Seasonal electricity consumption	kWh/a H	631	686	878	1217	1309	1430	2149

**SHORAI EDGE BLACK & WHITE- R32 Physical data indoor**

Indoor unit White		RAS-B07G3KVSG-E	RAS-B10G3KVSG-E	RAS-B13G3KVSG-E	RAS-B16G3KVSG-E	RAS-B18G3KVSG-E	RAS-B22G3KVSG-E	RAS-B24G3KVSG-E
Indoor unit Black		RAS-B07G3KVSGB-E	RAS-B10G3KVSGB-E	RAS-B13G3KVSGB-E	RAS-B16G3KVSGB-E	RAS-B18G3KVSGB-E	RAS-B22G3KVSGB-E	RAS-B24G3KVSGB-E
Air Flow (h)	m³/h - l/s C	660 - 183	660 - 183	732 - 203	750 - 208	990 - 274	1032 - 286	1122 - 311
Air Flow (l)	m³/h - l/s C	312 - 86	312 - 86	342 - 95	360 - 100	570 - 158	690 - 191	720 - 199
Sound pressure level (h/a)	dB(A) C	40/19	40/19	43/19	44/21	44/26	45/27	47/28
Sound power level (h)	dB(A) C	53	53	56	57	57	58	60
Air Flow (h)	m³/h - l/s H	660 - 183	660 - 183	732 - 203	768 - 213	990 - 274	1080 - 299	1140 - 316
Air Flow (l)	m³/h - l/s H	312 - 86	312 - 86	342 - 95	360 - 100	570 - 158	690 - 191	750 - 208
Sound pressure level (h/a)	dB(A) H	40/19	40/19	43/19	44/22	44/26	46/27	48/28
Sound power level (h)	dB(A) H	53	53	56	57	57	59	61
Dimensions (hxwxwd)	mm	293x800x226	293x800x226	293x800x226	293x800x226	320x1053x245	320x1053x245	320x1053x245
Weight	kg	10	10	10	10	14	14	14
Remote controller (White)		WH-UA06UE	WH-UA06UE	WH-UA06UE	WH-UA06UE	WH-UA06UE	WH-UA06UE	WH-UA06UE
Remote controller (Black)		WH-UA04UE	WH-UA04UE	WH-UA04UE	WH-UA04UE	WH-UA04UE	WH-UA04UE	WH-UA04UE

**SHORAI EDGE BLACK & WHITE- R32 Physical data outdoor**

Outdoor unit		RAS-07J2AVSG-E1	RAS-10J2AVSG-E1	RAS-13J2AVSG-E1	RAS-16J2AVSG-E1	RAS-18J2AVSG-E1	RAS-22J2AVSG-E1	RAS-24J2AVSG-E1
Air Flow (max)	m³/h - l/s C	1890 - 524	1890 - 524	1950 - 540	2040 - 566	2076 - 576	2184 - 607	2916 - 810
Sound pressure level (h)	dB(A) C	44	44	46	48	48	49	50
Sound pressure level (Silent CDU#2)	dB(A) C	36	37	39	40	42	43	43
Sound power level (h)	dB(A) C	57	57	59	61	63	62	63
Sound power level (Silent CDU#2)	dB(A) C	49	50	52	53	55	56	56
Operating range	°C C	-15~46	-15~46	-15~46	-15~46	-15~46	-15~46	-15~46
Air Flow (max)	m³/h - l/s H	1890 - 524	1890 - 524	1950 - 540	2040 - 566	2076 - 576	2184 - 607	2916 - 810
Sound pressure level (h)	dB(A) H	46	46	48	50	50	51	53
Sound pressure level (Silent CDU#2)	dB(A) H	38	39	43	43	44	46	46
Sound power level (h)	dB(A) H	59	59	61	63	63	64	66
Sound power level (Silent CDU#2)	dB(A) H	51	52	56	56	57	59	59
Operating range	°C H	-15~24	-15~24	-15~24	-15~24	-15~24	-15~24	-15~24
Dimensions (hxwxwd)	mm	550x780x290	550x780x290	550x780x290	550x780x290	550x780x290	550x780x290	630x800x300
Weight	kg	26	26	30	33	34	34	42
Compressor type		DC Rotary	DC Rotary	DC Rotary	DC Rotary	DC Twin Rotary	DC Twin Rotary	DC Twin Rotary
Flare connections (gas-liquid)		3/8" - 1/4"	3/8" - 1/4"	3/8" - 1/4"	1/2" - 1/4"	1/2" - 1/4"	1/2" - 1/4"	1/2" - 1/4"
Minimum pipe length	m	2	2	2	2	2	2	2
Maximum pipe length	m	20	20	20	20	20	20	25
Maximum height difference	m	12	12	12	12	12	12	15
Chargeless pipe length	m	15	15	15	15	15	15	15
Refrigerant charging(R32)	kg	0.55	0.55	0.8	0.8	1.1	1.1	1.14
Power supply	V-ph-Hz	230-1-50	230-1-50	230-1-50	230-1-50	230-1-50	230-1-50	230-1-50

C: cooling mode  
H: heating mode



RAS-E2KVG-E  
**SEIYA**

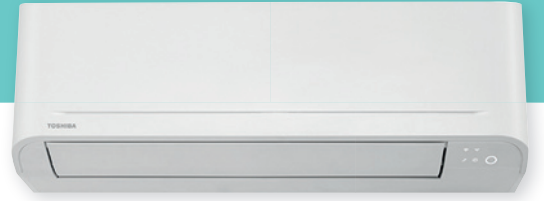

SEIYA, "Silent night" in Japanese, is a silent solution that uses the new Toshiba Inverter and compressor technologies with R32 to offer A++ cooling and heating performances, leading to true energy savings and year-round comfort.  
Compatible with Monosplit & Multisplit outdoor units (B-codes).

**High Energy Class A++ / A++**

- A unique performance/price ratio that allows optimal comfort and extra-low energy consumption in both cooling and heating mode.

**Extremely silent operation**

- SEIYA's Silent function halves the sound level of the outdoor unit, while its Quiet function reduces noise from the indoor unit for a good night's sleep.

**Indoor Air Quality**

- SEIYA is equipped with the Ultra Fresh filter® that captures up to 85% of PM2.5, protecting from atmospheric pollution and creating healthy living spaces at home.
- The Magic Coil® which helps prevent water and dust from sticking to the coil. When the air conditioning is switched off to drain the contaminated coil, the fan continues to operate to keep the coil clean and dry whilst preserving the air conditioning high energy efficiency.

**User friendly remote control with weekly timer**

- Quiet mode for Comfort Sleep operating indoor at the lowest noise level.
- Silent CDU is Toshiba's unique noise reduction function of outdoor unit for neighborhood comfort.
- High Power capacity booster to reach comfort set point very fast.
- ON-OFF timer provides a very convenient automatic programmable stop function.
- On-demand Defrost for manual defrost at any time in extreme conditions.

MAX EFFICIENCY



SEER 7.0  
SCOP 4.6

CAPACITY



1.5kW > 6.5kW

OPERATION



-15°C > +46°C

> **Elegant & modern design** with discreet dimming lights

> **100% Toshiba quality with DC rotary inverter compressor**

> **Wi-Fi control ready with Toshiba Home AC Control** adaptor

> **Silent modes** with indoor unit Quiet mode & Silent outdoor unit function

> **Wireless function** which allows to wire the remote to the indoor unit



**INDOOR UNITS**

- RAS-B05E2KVG-E
- RAS-B07E2KVG-E
- RAS-B10E2KVG-E
- RAS-B13E2KVG-E
- RAS-B16E2KVG-E
- RAS-18E2KVG-E
- RAS-24E2KVG-E



**OUTDOOR UNITS**

- RAS-05E2AVG-E
- RAS-07E2AVG-E
- RAS-10E2AVG-E
- RAS-13E2AVG-E
- RAS-16E2AVG-E
- RAS-18E2AVG-E
- RAS-24E2AVG-E



**REMOTE CONTROLS**

Delivered with the unit



**OPTIONAL RC**

RB-RXS33-E  
Optional weekly timer  
Remote control

**SEIYA- R32 Performance data**

Outdoor unit	Europe	RAS-05E2AVG-E	RAS-07E2AVG-E	RAS-10E2AVG-E	RAS-13E2AVG-E	RAS-16E2AVG-E	RAS-18E2AVG-E	RAS-24E2AVG-E
Indoor unit		RAS-B05E2KVG-E	RAS-B07E2KVG-E	RAS-B10E2KVG-E	RAS-B13E2KVG-E	RAS-B16E2KVG-E	RAS-18E2KVG-E	RAS-24E2KVG-E
<b>Cooling capacity</b>	<b>kW</b>	<b>1.5</b>	<b>2.0</b>	<b>2.5</b>	<b>3.3</b>	<b>4.2</b>	<b>5.0</b>	<b>6.5</b>
Cooling range (min. - max.)	kW	(0.75 - 2.00)	(0.76 - 2.60)	(0.80 - 3.00)	(1.20 - 3.60)	(1.40 - 4.70)	(1.45 - 5.50)	(1.7 - 7.2)
Power input (min. -rated - max.)	kW C	(0.20 - 0.36 - 0.57)	(0.20 - 0.53 - 0.83)	(0.20 - 0.70 - 1.00)	(0.25 - 1.10 - 1.25)	(0.34 - 1.27 - 1.60)	(0.34 - 1.50 - 1.80)	(0.41 - 2.25 - 2.60)
Pdesignc	kW	1.5	2.0	2.5	3.3	4.2	5.0	6.5
EER	W/W	4.17	3.77	3.57	3.00	3.31	3.33	2.89
SEER		6.9	6.9	7.0	7.0	7.0	7.0	6.9
Energy efficiency class	C	A++	A++	A++	A++	A++	A++	A++
Seasonal electricity consumption	kWh/a C	76	101	125	165	210	250	330
<b>Heating capacity</b>	<b>kW</b>	<b>2.0</b>	<b>2.5</b>	<b>3.2</b>	<b>3.6</b>	<b>5.0</b>	<b>5.4</b>	<b>7.0</b>
Heating range (min. - max.)	kW	(0.8 - 3.00)	(0.82 - 3.30)	(0.95 - 3.90)	(0.97 - 4.50)	(1.30 - 6.00)	(1.35 - 6.00)	(1.5 - 8.1)
Power input (min. -rated - max.)	kW H	(0.16 - 0.47 - 0.85)	(0.16 - 0.64 - 0.94)	(0.18 - 0.86 - 1.11)	(0.18 - 0.92 - 1.25)	(0.24 - 1.34 - 1.70)	(0.26 - 1.50 - 1.80)	(0.29 - 2.10 - 2.55)
Pdesignh (Tbiv-7°C)	kW	1.6	2.0	2.4	2.7	3.6	3.8	5.4
COP	W/W	4.26	3.91	3.72	3.91	3.73	3.60	3.33
SCOP		4.6	4.6	4.6	4.6	4.6	4.4	4.3
Energy efficiency class	H	A++	A++	A++	A++	A++	A+	A+
Seasonal electricity consumption	kWh/a H	487	609	730	822	1095	1209	1757
SCOP (warm climate)		5.20	5.34	5.38	5.40	5.57	5.62	5.35
Energy efficiency class (warm climate)		A+++	A+++	A+++	A+++	A+++	A+++	A+++

**SEIYA- R32 Physical data indoor**

Indoor unit	Europe	RAS-B05E2KVG-E	RAS-B07E2KVG-E	RAS-B10E2KVG-E	RAS-B13E2KVG-E	RAS-B16E2KVG-E	RAS-18E2KVG-E	RAS-24E2KVG-E
Air flow (h)	m³/h - l/s C	480 - 134	500 - 140	510 - 142	540 - 152	750 - 208	790 - 222	1070 - 298
Air flow (l)	m³/h - l/s C	199 - 55	209 - 58	233 - 64	259 - 72	330 - 92	480 - 133	666 - 185
Sound pressure level (h/q)	dB(A) C	37/19	38/19	39/19	41/20	43/21	47/26	48/29
Sound power level (h)	dB(A) C	50	51	52	54	56	60	61
Air flow (h)	m³/h - l/s H	480 - 134	500 - 140	510 - 144	560 - 158	760 - 213	840 - 233	860 - 234
Air flow (l)	m³/h - l/s H	199 - 55	209 - 58	233 - 64	271 - 75	340 - 94	500 - 139	730 - 203
Sound pressure level (h/q)	dB(A) H	37/19	38/19	39/20	42/20	43/22	48/26	48/29
Sound power level (h)	dB(A) H	50	51	52	55	56	61	61
Dimensions (hwxwd)	mm	288 x 770 x 225	288 x 770 x 225	288 x 770 x 225	288 x 770 x 225	293 x 798 x 230	293 x 798 x 230	320 x 1050 x 250
Weight	kg	9	9	9	9	9	9	15

**SEIYA- R32 Physical data outdoor**

Outdoor unit	Europe	RAS-05E2AVG-E	RAS-07E2AVG-E	RAS-10E2AVG-E	RAS-13E2AVG-E	RAS-16E2AVG-E	RAS-18E2AVG-E	RAS-24E2AVG-E
Air flow (max)	m³/h - l/s C	1690 - 470	1800 - 500	1800 - 500	1980 - 550	2160 - 600	2160 - 600	2220 - 617
Sound pressure level (h)	dB(A) C	47	47	47	48	50	50	54
Sound pressure level (Silent CDU#2)	dB(A) C	42	42	43	43	43	44	49
Sound power level (h)	dB(A) C	60	60	60	61	63	63	67
Sound power level (Silent CDU#2)	dB(A) C	55	55	56	56	56	57	62
Operating range	°C C	-15 ~ 46	-15 ~ 46	-15 ~ 46	-15 ~ 46	-15 ~ 46	-15 ~ 46	-15 ~ 46
Air flow (max)	m³/h - l/s H	1690 - 470	1800 - 500	1800 - 500	1980 - 550	2160 - 600	2160 - 600	2220 - 617
Sound pressure level (h)	dB(A) H	48	49	49	49	51	51	54
Sound pressure level (Silent CDU#2)	dB(A) H	42	42	43	43	46	46	49
Sound power level (h)	dB(A) H	61	62	62	62	64	64	67
Sound power level (Silent CDU#2)	dB(A) H	55	55	56	56	59	59	62
Operating range	°C H	-15 ~ 24	-15 ~ 24	-15 ~ 24	-15 ~ 24	-15-24	-15-24	-15-24
Dimensions (hwxwd)	mm	530 x 660 x 240	530 x 660 x 240	530 x 660 x 240	530 x 660 x 240	550 x 780 x 290	550 x 780 x 290	550 x 780 x 290
Weight	kg	21	21	22	22	30	34	38
Compressor type		DC Rotary	DC Rotary	DC Rotary	DC Rotary	DC Rotary	DC Rotary	DC Twin Rotary
Flare connections (gas-liquid)		3/8" - 1/4"	3/8" - 1/4"	3/8" - 1/4"	3/8" - 1/4"	1/2" - 1/4"	1/2" - 1/4"	1/2" - 1/4"
Minimum pipe length	m	2	2	2	2	2	2	2
Maximum pipe length	m	15	15	15	15	20	20	20
Maximum height difference	m	12	12	12	12	12	12	12
Chargeless pipe length	m	15	15	15	15	15	15	15
Remote controller		WH-TG01NE	WH-TG01NE	WH-TG01NE	WH-TG01NE	WH-TG01NE	WH-TG01NE	WH-TG01NE
Refrigerant charge (R32)	kg	0.34	0.34	0.49	0.54	0.68	0.93	1.18
Power supply	V-ph-Hz	220-240/1/50	220-240/1/50	220-240/1/50	220-240/1/50	220-240/1/50	220-240/1/50	220-240/1/50

C: cooling mode  
H: heating mode

RAS-J2FVG-E  
CONSOLE



This innovative and compact unit has been designed to be installed on the floor and in low wall applications, fitting perfectly under the window sills or in a low ceiling attic. The Console is compatible with Monosplit & Multisplit condensing units (B-code). Compact and modern design in all three dimensions (H600 x L700 x D220 cm).

**Energy efficiency class A++ / A++**

- High energy efficiency class in cooling.
- Low energy consumption in all conditions.

**Bi-flow air diffusion system**

- This feature enables users to select the favorable air flow outlet between the two available positions at the top and bottom front of the unit.
- The unique floor heating function, allows the unit to deliver a powerful flow at floor level for a uniform and comfortable room heating.

**Toshiba Indoor Air Quality filtration system**

- Toshiba IAQ's technology is able to seriously inhibit the reproductive ability of harmful elements. Its deodorizing power absorbs and decomposes, smoke, food smells and bad odors.
- Toshiba's new self-cleaning function is designed to reduce the humidity that causes mould to form inside an air-conditioning unit. This advanced, efficient system reduces moisture in the coils for healthier air to breathe.

**User friendly wireless remote control with weekly timer**

- Child-lock function on the unit display panel.
- Brightness level control of the display unit to reduce the led light glow.  
Automatic restart function in case of unexpected electricity supply line power cuts.
- Standard Toshiba functions: Weekly timer 24h, Power select, 8°C.

MAX EFFICIENCY



SEER 7.20  
SCOP 4.7

CAPACITY



2.5kW > 5.0kW

OPERATION



-15°C > +46°C

- > B-code for Mono & Multi compatibility
- > 100% Toshiba quality with DC Twin Rotary inverter compressor on large chassis
- > Wifi control compatible
- > Toshiba Indoor Air Quality filters
- > Floor warming
- > Silent CDU mode
- > Fire place mode
- > On demand defrost



INDOOR UNITS

RAS-B10J2FVG-E  
RAS-B13J2FVG-E  
RAS-B18J2FVG-E



OUTDOOR UNITS

RAS-10J2AVSG-E1  
RAS-13J2AVSG-E1  
RAS-18J2AVSG-E1



REMOTE CONTROLS

WH-TA12LE  
delivered with the unit



### CONSOLE Performance data

Outdoor unit			RAS-10J2AVSG-E1	RAS-13J2AVSG-E1	RAS-18J2AVSG-E1
Indoor unit			RAS-B10J2FVG-E	RAS-B13J2FVG-E	RAS-B18J2FVG-E
<b>Cooling capacity</b>	<b>kW</b>		<b>2,5</b>	<b>3,5</b>	<b>5,0</b>
Cooling range (min. - max.)	kW		0.95 - 3.2	1.05 - 4.1	1.2 - 5.6
Power input (min. -rated - max.)	kW	C	0.21 - 0.59 - 0.90	0.27 - 0.87 - 1.20	0.34 - 1.68 - 2.00
Pdesignc	kW		2.5	3.5	5.0
EER	W/W		4.24	4.02	2.98
SEER			7.2	7.0	6.8
Energy efficiency class		C	A++	A++	A++
Seasonal electricity consumption	kWh/a	C	121	174	257
<b>Heating capacity</b>	<b>kW</b>		<b>3.2</b>	<b>4.2</b>	<b>6.0</b>
Heating range (min. - max.)	kW		0.85 - 4.40	1.0 - 5.0	1.3 - 6.3
Power input (min. -rated - max.)	kW	H	0.18 - 0.82 - 1.25	0.22 - 1.27 - 1.55	0.31 - 2.05 - 2.20
Pdesignh	kW		2.5	3.0	4.0
COP	W/W		3.90	3.31	2.93
SCOP			4.7	4.7	4.6
Energy efficiency class		H	A++	A++	A++
Seasonal electricity consumption	kWh/a	H	744	893	1217

### CONSOLE Physical data indoor

Indoor unit			RAS-B10J2FVG-E	RAS-B13J2FVG-E	RAS-B18J2FVG-E
Air Flow (h)	m <sup>3</sup> /h - l/s	C	492 - 136	528 - 146	600 - 166
Air Flow (l)	m <sup>3</sup> /h - l/s	C	258 - 71	270 - 75	366 - 101
Sound pressure level (h/q)	dB(A)	C	39/23	40/24	46/31
Sound power level (h)	dB(A)	C	52	53	59
Air Flow (h)	m <sup>3</sup> /h - l/s	H	492 - 136	552 - 153	660 - 183
Air Flow (l)	m <sup>3</sup> /h - l/s	H	258 - 71	288 - 80	366 - 101
Sound pressure level (h/q)	dB(A)	H	39/23	40/24	47/31
Sound power level (h)	dB(A)	H	52	53	60
Dimensions (h x w x d)	mm		600 x 700 x 220	600 x 700 x 220	600 x 700 x 220
Weight	kg		16	16	16

### CONSOLE Physical data outdoor

Outdoor unit			RAS-10J2AVSG-E1	RAS-13J2AVSG-E1	RAS-18J2AVSG-E1
Air Flow (max)	m <sup>3</sup> /h - l/s	C	1890 - 524	1950 - 540	2076 - 576
Sound pressure level (h)	dB(A)	C	45	47	49
Sound pressure level (Silent CDU#2)	dB(A)	C	38	40	43
Sound power level (h)	dB(A)	C	58	60	62
Sound power level (Silent CDU#2)	dB(A)	C	51	53	56
Operating range	°C	C	-15 ~ 46	-15 ~ 46	-15 ~ 46
Air Flow (max)	m <sup>3</sup> /h - l/s	H	1890 - 524	1950 - 540	2076 - 576
Sound pressure level (h)	dB(A)	H	47	49	51
Sound pressure level (Silent CDU#2)	dB(A)	H	40	43	45
Sound power level (h)	dB(A)	H	60	62	64
Sound power level (Silent CDU#2)	dB(A)	H	53	57	58
Operating range	°C	H	-15 ~ 24	-15 ~ 24	-15 ~ 24
Dimensions (h x w x d)	mm		550 x 780 x 290	550 x 780 x 290	550 x 780 x 290
Weight	kg		26	30	34
Compressor type			DC Rotary	DC Rotary	DC Twin Rotary
Flare connections (gas-liquid)			3/8" - 1/4"	3/8" - 1/4"	1/2" - 1/4"
Minimum pipe length	m		2	2	2
Maximum pipe length	m		20	20	20
Maximum height difference	m		12	12	12
Chargeless pipe length	m		15	15	15
Refrigerant charging(R32)	kg		0.55	0.8	1.10
Power supply	V-ph-Hz		230-1-50	230-1-50	230-1-50

C: cooling mode  
H: heating mode

QUALITY RELIABILITY ENVIRONMENT PROFITABILITY SIMPLICITY

**RESIDENTIAL**  
AIR-TO-AIR  
MULTISPLIT





QUALITY RELIABILITY ENVIRONMENT PROFITABILITY SIMPLICITY

➤ “Committed to efficiency and comfort”

Every field has its own requirements and specifics directly related to its business and the space it occupies, be it residential, shops, offices or hotels. Toshiba reinvigorates spaces, creates comfortable environments and encourages productivity.

## MULTISPLIT



### Comfort & flexibility

- Toshiba Inverter multi-split systems feature higher standards of indoor air quality, sound levels and environmental awareness. Special attention has been dedicated to night-time comfort, with the improvement of the silent operation mode, available in indoor units.
- One outdoor unit can serve up to five indoor units for exceptional flexibility and reliability. Toshiba Inverter multi system outdoor units are lightweight and compact. Just one outdoor unit takes up little space on a wall or in a yard. It keeps the exterior of buildings neat with quieter operation. Choose from four types of indoor units, high-wall, ducted, compact 4-way cassette and console type to suit any application.

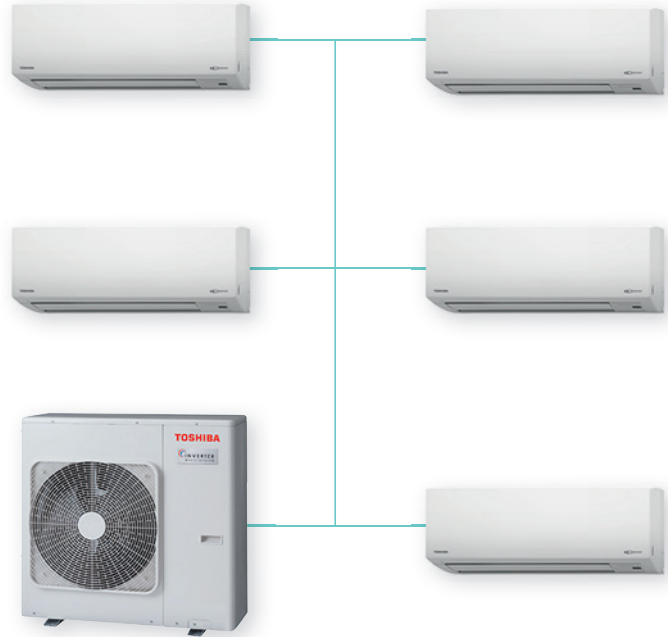

### High quality & savings

- Toshiba high-quality multi-split systems contribute to drastically reducing operating costs and increasing energy efficiency. The multi-split outdoor unit achieves efficiency in partial load conditions where the Toshiba inverters deliver their best performance. Toshiba's new super-efficient DC twin-rotary compressor enables top-class performance at low energy Consumption (SEER up to 6.90 & SCOP up to 4.60). With this efficient unit, operating costs decrease dramatically, compared to other multi-split systems.
- Toshiba solutions are studied and verified in every tiny element and are recognised universally by air conditioning professionals for their total reliability. In fact, for Toshiba quality has always been a priority and today and into the future, the quality of Toshiba products will continue to differentiate us from other manufacturers.



Fast and precise temperature management, with Toshiba Twin-rotary Inverter compressors.



**MULTISPLIT INVERTER R32 & R410A**

**Luxury through technology in RAS multi-split inverter systems**

- From 2 to 5 rooms with high efficiency product.
- Just one outdoor unit can serve up to five indoor rooms.
- Wide choice of internal units: high-walls, cassettes, duct-type and/or console.
- Compressor DC Twin-Rotary on the whole range.
- Large operating map down to -20°C in heating mode and up to +46°C in cooling.
- Up to 80 meters of frigorific connections for any installation type.
- Full line up available with R32.

**Space saving & silent**

- Toshiba multi-split inverter system outdoor units are lightweight and compact. Just one outdoor unit takes up little space on a wall or in a yard. It keeps the exterior of buildings looking neat and offers quiet operating noise levels.

**INDOOR UNITS**



DAISEIKAI 9  
HAORI  
SHORAI EDGE  
SEIYA

CONSOLE  
DUCT  
Compact CASSETTE

**OUTDOOR UNITS**



RAS-2M10G3AVG-E  
RAS-2M14G3AVG-E

RAS-2M18G3AVG-E  
RAS-3M18G3AVG-E

RAS-3M26G3AVG-E  
RAS-4M27G3AVG-E  
RAS-5M34G3AVG-E

**CONTROLS**



Wireless remote controls

Weekly remote control optional

Wired remote control (Cassette & Duct only)



MAX EFFICIENCY



SEER 8.7  
SCOP 4.8

CAPACITY



3kW > 10kW

OPERATION



-20°C > +46°C

RESIDENTIAL AIR-TO-AIR

# CHOOSE YOUR ADAPTED SYSTEM SOLUTION



		MULTISPLIT INDOOR UNITS							
Indoor Units sizes		05	07	10	13	16	18	22	24
Indoor Units cooling capacity		1.5 kW	2.0 kW	2.5 kW	3.5 kW	4.5 kW	5.0 kW	6.0 kW	7.0 kW
Hi-wall - DAISEIKAI 9 RAS-M**PKVPG-E/TR				•	•	•			
Hi-wall - HAORI RAS-M**N4KVRG-E/TR RAS-B**N4KVRG-E/TR			•	•	•	•			
Hi-wall - SHORAI Edge black or white RAS-B**G3KVS(B)-E/TR		•	•	•	•	•	•	•	•
Hi-wall - SEIYA RAS-B**E2KVG-E/TR		•	•	•	•	•			
Console RAS-B**J2FVG-E/TR			•	•	•		•		
Compact Cassette RAS-M**U2MUVG-E/TR				•	•	•			
Ducted RAS-M**U2DVG-E1/TR			•	•	•	•		•	•

• : Indoor units available sizes

		MULTISPLIT OUTDOOR							
Outdoor Units sizes		05	07	10	13	16	18	22	24
Outdoor units Cooling capacity		1.5 kW	2.0 kW	2.5 kW	3.5 kW	4.5 kW	5.0 kW	6.0 kW	7.0 kW
2 Rooms RAS-2M10G3AVG-E/TR CDU Cooling capacity: 3.3 kW		•	•	•					
2 Rooms RAS-2M14G3AVG-E/TR CDU Cooling capacity: 4.0 kW		•	•	•	•				
2 Rooms RAS-2M18G3AVG-E/TR CDU Cooling capacity: 5.2 kW		•	•	•	•	•			
3 Rooms RAS-3M18G3AVG-E/TR CDU Cooling capacity: 5.2 kW		•	•	•	•	•			
3 Rooms RAS-3M26G3AVG-E/TR CDU Cooling capacity: 7.5 kW		•	•	•	•	•	•	•	•
4 Rooms RAS-4M27G3AVG-E/TR CDU Cooling capacity: 8.0 kW		•	•	•	•	•	•	•	•
5 Rooms RAS-5M34G3AVG-E/TR CDU Cooling capacity: 10.0 kW		•	•	•	•	•	•	•	•

• : Indoor units sizes compatibility with outdoor units

COMPATIBILITIES	2 ROOMS			3 ROOMS		4 ROOMS	5 ROOMS
	RAS-2M10G3AVG-E/TR	RAS-2M14G3AVG-E/TR	RAS-2M18G3AVG-E/TR	RAS-3M18G3AVG-E/TR	RAS-3M26G3AVG-E/TR	RAS-4M27G3AVG-E/TR	RAS-5M34G3AVG-E/TR
IDU sizes							
05	•	•	•	•	•	•	•
07	•	•	•	•	•	•	•
10	•	•	•	•	•	•	•
13		•	•	•	•	•	•
16			•	•	•	•	•
18					•	•	•
22					•	•	•
24					•	•	•

• : compatibilities



## Performance data

Outdoor unit		2-room Multisplit	2-room Multisplit	2-room Multisplit	3-room Multisplit	3-room Multisplit	4-room Multisplit	5-room Multisplit
		RAS-2M10G3AVG-E	RAS-2M14G3AVG-E	RAS-2M18G3AVG-E	RAS-3M18G3AVG-E	RAS-3M26G3AVG-E	RAS-4M27G3AVG-E	RAS-5M34G3AVG-E
		RAS-2M10G3AVG-TR	RAS-2M14G3AVG-TR	RAS-2M18G3AVG-TR	RAS-3M18G3AVG-TR	RAS-3M26G3AVG-TR	RAS-4M27G3AVG-TR	RAS-5M34G3AVG-TR
<b>Cooling capacity</b>	<b>kW</b>	<b>3.3</b>	<b>4.0</b>	<b>5.2</b>	<b>5.2</b>	<b>7.0</b>	<b>8.0</b>	<b>10.0</b>
Cooling capacity (min. - max.)	kW	1.20 - 4.1	1.5 - 4.9	1.6 - 6.5	2.0 - 7.5	2.0 - 9.0	2.0 - 10.0	2.5 - 11.5
Power input	kW C	0.67	0.85	1.20	1.00	1.75	1.90	2.60
EER	W/W	4.93	4.71	4.33	5.20	4.00	4.21	3.85
SEER		8.6	8.7	8.7	8.6	8.5	8.3	7.2
Energy efficiency class	C	A+++	A+++	A+++	A+++	A+++	A++	A++
<b>Heating capacity</b>	<b>kW</b>	<b>4.0</b>	<b>4.4</b>	<b>5.6</b>	<b>6.8</b>	<b>8.7</b>	<b>9.0</b>	<b>12.0</b>
Heating capacity (min. - max.)	kW	1.00 - 4.90	1.00 - 5.20	1.30 - 8.20	1.90 - 8.30	2.0 - 11.5	2.0 - 12.0	2.2 - 14.2
Power input	kW H	0.85	0.90	1.14	1.45	2.00	1.90	2.80
COP	W/W	4.71	4.89	4.91	4.69	4.35	4.74	4.24
SCOP		4.7	4.8	4.8	4.8	4.6	4.5	4.3
Energy efficiency class	H	A++	A++	A++	A++	A++	A+	A+

## Physical data outdoor

Outdoor unit		2-room Multisplit	2-room Multisplit	2-room Multisplit	3-room Multisplit	3-room Multisplit	4-room Multisplit	5-room Multisplit
		RAS-2M10G3AVG-E	RAS-2M14G3AVG-E	RAS-2M18G3AVG-E	RAS-3M18G3AVG-E	RAS-3M26G3AVG-E	RAS-4M27G3AVG-E	RAS-5M34G3AVG-E
		RAS-2M10G3AVG-TR	RAS-2M14G3AVG-TR	RAS-2M18G3AVG-TR	RAS-3M18G3AVG-TR	RAS-3M26G3AVG-TR	RAS-4M27G3AVG-TR	RAS-5M34G3AVG-TR
Air Flow	m <sup>3</sup> /h - l/s C	2100-583	1800-500	2600-722	2600-722	3400-944	3400-944	3700-1028
Sound pressure level(r/l)	dB(A) C	47/43	46/41	48/45	48/45	49/43	50/44	52/45
Sound power level	dB(A) C	60	59	61	61	62	63	65
Operating range	°C C	-10/46	-10/46	-10/46	-10/46	-10/46	-10/46	-10/46
Air Flow	m <sup>3</sup> /h - l/s H	2100-583	2250-625	2600-722	2800-778	3700-1028	3700-1028	4400-1222
Sound pressure level(r/l)	dB(A) H	51/46	52/46	50/44	52/46	53/45	54/45	56/47
Sound power level	dB(A) H	64	65	63	65	66	67	69
Operating range	°C H	-20/24	-20/24	-20/24	-20/24	-20/24	-20/24	-20/24
Dimensions (HxWxD)	mm	550 x 780 x 290	550 x 780 x 290	630 x 800 x 300	630 x 800 x 300	890 x 900 x 320	890 x 900 x 320	890 x 900 x 320
Weight	kg	31	35	43	44	67	68	78
Compressor type		DC Single Rotary	DC Twin Rotary	DC Twin Rotary	DC Twin Rotary	DC Twin Rotary	DC Twin Rotary	DC Twin Rotary
Flare connections - gas		3/8" x 2	3/8" x 2	3/8" x 2	3/8" x 2 + 1/2"x1	3/8" x 1 + 1/2"x2	3/8" x 2 + 1/2"x2	3/8" x 3 + 1/2"x2
Flare connections - liquid		1/4" x 2	1/4" x 2	1/4" x 2	1/4" x 3	1/4" x 3	1/4" x 4	1/4" x 5
Maximum pipe length (per unit/total)	m	15/20	20/30	20/30	25/50	25/ 70	25 / 70	25 / 80
Maximum height difference	m	10	10	10	10	15	15	15
Refrigerant charge	kg	0.8	0.95	1.2	1.25	1.90	2.05	2.39
Chargeless pipe length	m	20	30	30	50	40	40	40
Power supply	V-ph-Hz	220/240-1-50	220/240-1-50	220/240-1-50	220/240-1-50	220/240-1-50	220/240-1-50	220/240-1-50

C: cooling mode  
H: heating mode  
-E: European Union  
-TR: Turkey



# RAS MULTI INDOOR UNITS



- Toshiba indoor air quality with Plasma Air Purifier
- 3D airflow with 6 unique airflow patterns
- Silent operation outdoor unit
- Wireless remote control adaptor inside FCU
- Self-cleaning function / Weekly timer / 8°C button
- Extremely silent operation

## Physical data indoor

Indoor unit			RAS-M10PKVPG-E RAS-M10PKVPG-TR	RAS-M13PKVPG-E RAS-M13PKVPG-TR	RAS-M16PKVPG-E RAS-M16PKVPG-TR
Air Flow	m³/h - l/s	C	672 - 187	672 - 187	732-203
Sound pressure level (h/l)	dB(A)	C	42/20	44/20	45/22
Sound power level (h/l)	dB(A)	C	57/35	59/35	60/37
Air Flow	m³/h - l/s	H	726 - 202	726 - 202	744-207
Sound pressure level (h/l)	dB(A)	H	44/20	44/20	46/22
Sound power level (h/l)	dB(A)	H	59/35	60/35	61/37
Dimensions (h x w x d)	mm		293 x 851 x 270	293 x 851 x 270	293 x 851 x 270
Weight	kg		14	14	14
Flare connections (gas-liquid)			3/8" - 1/4"	3/8" - 1/4"	3/8" - 1/4"



- Truly elegant design featuring a stylish textile fabric cover
- Toshiba Ultra Pure Filter PM 2.5 & Toshiba Plasma Ionizer
- Toshiba HAORI luxury remote control
- Wifi adaptor inside FCU
- Silent operation

## Physical data indoor

Indoor unit			RAS-M07N4KVRG-E RAS-M07N4KVRG-TR	RAS-B10N4KVRG-E RAS-B10N4KVRG-TR	RAS-B13N4KVRG-E RAS-B13N4KVRG-TR	RAS-B16N4KVRG-E RAS-B16N4KVRG-TR
Air flow (h)	m³/h - l/s	C	600 - 166	600 - 166	670 - 186	690 - 180
Sound pressure level (h/q)	dB(A)	C	41/19	41/19	43/19	45/21
Sound power level (h)	dB(A)	C	54	54	56	58
Air flow (h)	m³/h - l/s	H	610 - 169	610 - 169	680 - 189	730 - 186
Sound pressure level (h/q)	dB(A)	H	41/19	41/19	43/19	45/22
Sound power level (h)	dB(A)	H	54	54	56	58
Dimensions (hxwx d)	mm		300 x 987 x 210	300 x 987 x 210	300 x 987 x 210	300 x 987 x 210
Weight	kg		11	11	11	12
Flare connections (gas-liquid)			3/8" - 1/4"	3/8" - 1/4"	3/8" - 1/4"	1/2" - 1/4"



- Toshiba Ultra Pure Filter PM2.5
- 3D airflow with 6 unique airflow patterns (22k&24k)
- Wifi adaptor inside FCU
- HADA care flow
- Silent operation

## Physical data indoor

Indoor unit	White IDU		RAS-M05G3KVSG-E RAS-M05G3KVSG-TR	RAS-B07G3KVSG-E RAS-B07G3KVSG-TR	RAS-B10G3KVSG-E RAS-B10G3KVSG-TR	RAS-B13G3KVSG-E RAS-B13G3KVSG-TR	RAS-B16G3KVSG-E RAS-B16G3KVSG-TR	RAS-B18G3KVSG-E RAS-B18G3KVSG-TR	RAS-B22G3KVSG-E RAS-B22G3KVSG-TR	RAS-B24G3KVSG-E RAS-B24G3KVSG-TR
	Black IDU		RAS-M05G3KVSGB-E RAS-M05G3KVSGB-TR	RAS-B07G3KVSGB-E RAS-B07G3KVSGB-TR	RAS-B10G3KVSGB-E RAS-B10G3KVSGB-TR	RAS-B13G3KVSGB-E RAS-B13G3KVSGB-TR	RAS-B16G3KVSGB-E RAS-B16G3KVSGB-TR	RAS-B18G3KVSGB-E RAS-B18G3KVSGB-TR	RAS-B22G3KVSGB-E RAS-B22G3KVSGB-TR	RAS-B24G3KVSGB-E RAS-B24G3KVSGB-TR
Air Flow	m³/h - l/s	C	600 - 168	660 - 183	660 - 183	730 - 203	750 - 208	990 - 275	1032 - 286	1120 - 311
Sound pressure level (h/l)	dB(A)	C	37/19	40/19	40/19	43/ 19	44/21	44/26	45/27	47/28
Sound power level (h/l)	dB(A)	C	50/32	53/32	53/32	56/32	57/34	57/39	58/40	60/41
Air Flow	m³/h - l/s	H	600 - 168	660 - 183	660 - 183	730 - 203	760 - 211	990 - 275	1080 - 300	1140 - 316
Sound pressure level (h/l)	dB(A)	H	37/19	40/19	40/19	43/19	44/22	44/26	46/27	48/28
Sound power level (h)	dB(A)	H	50/32	53/32	53/32	56/32	57/35	57/39	59/40	61/41
Dimensions (h x w x d)	mm		293x800x226	293x800x226	293x800x226	293x800x226	293x800x226	320x1053x245	320x1053x245	320x1053x245
Weight	kg		9	10	10	10	10	14	14	14
Flare connections (gas-liquid)			3/8" - 1/4"	3/8" - 1/4"	3/8" - 1/4"	3/8" - 1/4"	1/2" - 1/4"	1/2" - 1/4"	1/2" - 1/4"	1/2" - 1/4"



- Elegant compact design
- Toshiba Ultra Fresh Filter PM2.5
- WiFi adaptor inside FCU
- Silent operation

## Physical data indoor

Indoor unit			RAS-B05E2KVG-E RAS-M05E2KVG-TR	RAS-B07E2KVG-E RAS-M07E2KVG-TR	RAS-B10E2KVG-E RAS-M10E2KVG-TR	RAS-B13E2KVG-E RAS-M13E2KVG-TR	RAS-B16E2KVG-E RAS-M16E2KVG-TR
Air flow	m³/h - l/s	C	480 - 134	500 - 140	510 - 142	540 - 150	750 - 208
Sound pressure level (h/q)	dB(A)	C	37/19	38/19	39/19	41/20	43/21
Sound power level (h)	dB(A)	C	50	51	52	54	56
Air flow	m³/h - l/s	H	480- 134	500 - 140	510 - 144	560 - 158	760 - 212
Sound pressure level (h/q)	dB(A)	H	37/19	38/19	39/20	42/20	43/22
Sound power level (h)	dB(A)	H	50	51	52	55	56
Dimensions (h x w x d)	mm		288 x 770 x 225	288 x 770 x 225	288 x 770 x 225	288 x 770 x 225	293 x 798 x 230
Weight	kg		9	9	9	9	10
Flare connections (gas-liquid)			3/8" - 1/4"	3/8" - 1/4"	3/8" - 1/4"	3/8" - 1/4"	1/2" - 1/4"

C: cooling mode  
H: heating mode

## INDOOR UNITS

### CONSOLE



- Bi-flow air delivery system (floor heating)
- Silent operation outdoor unit
- Wireless remote control
- R32 refrigerant gas sensor accessory inside FCU (RB-I301-E)

#### Physical data indoor

Indoor unit			RAS-M07J2FVG-E	RAS-B10J2FVG-E RAS-M10J2FVG-TR	RAS-B13J2FVG-E RAS-M13J2FVG-TR	RAS-B18J2FVG-E RAS-M18J2FVG-TR
Air Flow	m <sup>3</sup> /h - l/s	C	490 - 136	492 - 136	528 - 146	600 - 167
Sound pressure level (h/l)	dB(A)	C	39/23	39/23	40/24	46/31
Sound power level (h/l)	dB(A)	C	52/36	52/36	53/37	59/44
Air Flow	m <sup>3</sup> /h - l/s	H	490 - 136	492 - 136	552 - 153	660 - 183
Sound pressure level (h/l)	dB(A)	H	39/23	39/23	40/24	47/31
Sound power level (h/l)	dB(A)	H	52/36	52/36	53/37	60/44
Dimensions (h x w x d)	mm		600 x 700 x 220	600 x 700 x 220	600 x 700 x 220	600 x 700 x 220
Weight	kg		16	16	16	16
Flare connections (gas-liquid)			3/8" - 1/4"	3/8" - 1/4"	3/8" - 1/4"	1/2" - 1/4"

C: cooling mode  
H: heating mode

### COMPACT CASSETTE



- 4 way air diffusion grille
- Elegant Flat Panel modern design & Compact dimensions to suit 600x600mm grid ceilings
- Wired or Wireless remote control / Occupancy sensor option
- Individual louver control / Dual & cycle swing
- Condensate drain pump included (up to 850mm height)

#### Physical data indoor

Indoor unit			RAS-M10U2MUVG-E RAS-M10U2MUVG-TR	RAS-M13U2MUVG-E RAS-M13U2MUVG-TR	RAS-M16U2MUVG-E RAS-M16U2MUVG-TR
Air flow (h/l)	m <sup>3</sup> /h	C	590/430	620/430	680/450
Sound pressure level (h/l)	dB(A)	C	37/30	38/30	41/31
Sound power level	dB(A)	C	52/45	53/45	56/46
Air flow (h/l)	m <sup>3</sup> /h	H	590/430	620/430	680/450
Sound pressure level (h/l)	dB(A)	H	37/30	38/30	41/31
Sound power level	dB(A)	H	52/45	53/45	56/46
Dimensions (h x w x d)	mm		256 x 575 x 575	256 x 575 x 575	256 x 575 x 575
Weight	kg		15	15	15
Flare connections (gas - liquid)			3/8" - 1/4"	3/8" - 1/4"	1/2" - 1/4"

C: cooling mode  
H: heating mode

### DUCTED

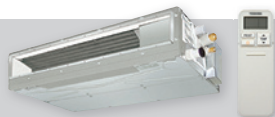

- Slim unit (only 210mm height)
- Adjustable external static pressure
- Condensate drain pump included (up to 350mm height)
- Air filters in option

Indoor unit			RAS-M07U2DVG-E RAS-M07U2DVG-TR	RAS-M10U2DVG-E RAS-M10U2DVG-TR	RAS-M13U2DVG-E RAS-M13U2DVG-TR	RAS-M16U2DVG-E RAS-M16U2DVG-TR	RAS-M22U2DVG-E RAS-M22U2DVG-TR	RAS-M24U2DVG-E RAS-M24U2DVG-TR
Air flow (h/l)	m <sup>3</sup> /h	C	570 / 380	570 / 380	610 / 385	780 / 420	1000/740	1060/760
Sound pressure level (h/l) *1	dB(A)	C	35 / 27	35 / 27	37 / 27	35 / 24	38/32	39/33
Sound power level (h/l) *1	dB(A)	C	50 / 42	50 / 42	52 / 42	50 / 39	53/47	54/48
Air flow (h/l)	m <sup>3</sup> /h - l/s	H	570 / 380	570 / 380	610 / 385	780 / 450	1000/740	1060/760
Sound pressure level (h/l) *1	dB(A)	H	35 / 27	35 / 27	37 / 27	35 / 25	38/32	39/33
Sound power level (h/l) *1	dB(A)	H	50 / 42	50 / 42	52 / 42	50 / 40	53/47	54/48
Dimensions (h x w x d)	mm		210 x 700 x 450	210 x 700 x 450	210 x 700 x 450	210 x 900 x 450	210 x 1100 x 450	210 x 1100 x 450
Weight	kg		16	16	16	19	22	22
Flare connections (gas - liquid)			3/8" - 1/4"	3/8" - 1/4"	3/8" - 1/4"	1/2" - 1/4"	1/2" - 1/4"	1/2" - 1/4"
External static pressure (stand / middle1 / middle2 / upper)	Pa		10 / 20 / 35 /45	10 / 20 / 35 /45	10 / 20 / 35 /45	10 / 20 / 35 /45	10 / 20 / 35 /45	10 / 20 / 35 /45

C: cooling mode  
H: heating mode  
\*1:Back in Take. External static pressure 35Pa.

### OPTIONAL



**Wireless**  
Weekly Remote control

RB-RXS33-E  
for SEIYA



**Wall mounted**  
Weekly Remote control  
(Cassette & Duct only)

RB-RWS21-E



**RAS-2M10G3AVG-E / TR - Performances data Bi-split size 10**

Operating status	Combination		Unit capacity (kW)		Cooling capacity (kW)			Power input (W)			Operating current (A)			Lot.10 SEER	Class	EER Nom.			
	Unit A	Unit B	Unit A	Unit B	Min.	Nom.	Max.	Min.	Nom.	Max.	Nom.	Pdc	Lot.10 SCOP						
Cooling, 230 V	1 unit operation	05	-	1,50	-	1,00	1,50	2,00	230	362	500	-	-	-	-	-			
		07	-	2,00	-	1,00	2,00	2,90	230	487	890	-	-	-	-	-			
		10	-	2,50	-	1,00	2,50	3,20	230	662	1140	-	-	-	-	-			
Cooling, 230 V	2 unit operation	05	05	1,50	1,50	1,20	3,00	4,00	200	609	1040	3,18	3	8	A++	4,93			
		07	05	1,89	1,41	1,20	3,30	4,10	200	697	1050	3,39	3	8	A++	4,73			
		10	05	2,06	1,24	1,20	3,30	4,10	200	697	1050	3,39	3	8	A++	4,73			
		07	07	1,65	1,65	1,20	3,30	4,10	200	670	1050	3,31	3	9	A+++	4,93			
		10	07	1,83	1,47	1,20	3,30	4,10	200	670	1050	3,31	3	9	A+++	4,93			
		10	10	1,65	1,65	1,20	3,30	4,10	200	670	1050	3,31	3	9	A+++	4,93			
Operating status	Combination		Unit capacity (kW)		Heating capacity (kW)			Power input (W)			Operating current (A)			Lot.10 SCOP	Label Average climate	Label Warm climate	COP Nom.		
	Unit A	Unit B	Unit A	Unit B	Min.	Nom.	Max.	Min.	Nom.	Max.	Nom.	Pdh	Lot.10 SCOP					SCOP Warm climate	
Heating, 230 V	1 unit operation	05	-	2,00	-	0,90	2,00	2,50	210	460	690	-	-	-	-	-			
		07	-	2,50	-	0,90	2,50	3,60	190	520	920	-	-	-	-	-			
		10	-	3,20	-	0,90	3,20	4,80	190	740	1460	-	-	-	-	-			
	Heating, 230 V	2 unit operation	05	05	2,00	2,00	1,00	4,00	4,90	180	960	1240	4,45	3	5	6	A++	A+++	4
			07	05	2,22	1,78	1,00	4,00	4,90	170	880	1140	4,09	3	5	6	A++	A+++	5
			10	05	2,46	1,54	1,00	4,00	4,90	170	880	1140	4,09	3	5	6	A++	A+++	5
			07	07	2,00	2,00	1,00	4,00	4,90	170	840	1100	3,91	3	5	6	A++	A+++	5
			10	07	2,25	1,75	1,00	4,00	4,90	170	840	1100	3,91	3	5	6	A++	A+++	5
			10	10	2,00	2,00	1,00	4,00	4,90	170	840	1100	3,91	3	5	6	A++	A+++	5

**RAS-2M14G3AVG-E / TR - Performances data Bi-split size 14**

Operating status	Combination		Unit capacity (kW)		Cooling capacity (kW)			Power input (W)			Operating current (A)			Lot.10 SEER	Class	EER Nom.			
	Unit A	Unit B	Unit A	Unit B	Min.	Nom.	Max.	Min.	Nom.	Max.	Nom.	Pdc	Lot.10 SCOP						
Cooling, 230 V	1 unit operation	05	-	1,50	-	1,10	1,50	2,00	260	360	470	-	-	-	-	-			
		07	-	2,00	-	1,20	2,00	2,90	260	440	710	-	-	-	-	-			
		10	-	2,50	-	1,20	2,50	3,20	260	600	870	-	-	-	-	-			
		13	-	3,50	-	1,30	3,50	4,10	260	990	1300	-	-	-	-	-			
	Cooling, 230 V	2 unit operation	05	05	1,50	1,50	1,40	3,00	4,70	240	650	1250	3,26	3	8	A++	4,63		
			07	05	2,00	1,50	1,40	3,50	4,90	240	780	1250	3,64	4	8	A++	4,47		
			10	05	2,50	1,50	1,40	4,00	4,90	240	950	1250	4,41	4	8	A++	4,23		
			13	05	2,80	1,20	1,50	4,00	4,90	230	910	1200	4,23	4	8	A++	4,39		
			07	07	2,00	2,00	1,50	4,00	4,90	230	920	1250	4,27	4	8	A++	4,33		
			10	07	2,22	1,78	1,50	4,00	4,90	230	920	1200	4,27	4	8	A++	4,33		
			13	07	2,55	1,45	1,50	4,00	4,90	230	890	1180	4,14	4	8	A++	4,51		
			10	10	2,00	2,00	1,50	4,00	4,90	230	920	1200	4,27	4	8	A++	4,33		
			13	10	2,33	1,67	1,50	4,00	4,90	230	890	1150	4,14	4	8	A++	4,51		
13	13	2,00	2,00	1,50	4,00	4,90	230	850	1150	3,96	4	9	A+++	4,71					
Operating status	Combination		Unit capacity (kW)		Heating capacity (kW)			Power input (W)			Operating current (A)			Lot.10 SCOP	Label Average climate	Label Warm climate	COP Nom.		
	Unit A	Unit B	Unit A	Unit B	Min.	Nom.	Max.	Min.	Nom.	Max.	Nom.	Pdh	Lot.10 SCOP					SCOP Warm climate	
Heating, 230 V	1 unit operation	05	-	2,00	-	1,00	2,00	2,50	230	510	680	-	-	-	-	-			
		07	-	2,50	-	1,00	2,50	3,60	230	680	950	-	-	-	-	-			
		10	-	3,20	-	1,00	3,20	4,80	230	1010	1490	-	-	-	-	-			
		13	-	4,20	-	1,00	4,20	5,20	230	1400	1610	-	-	-	-	-			
	Heating, 230 V	2 unit operation	05	05	2,00	2,00	1,00	4,00	5,10	200	960	1300	4,45	3	5	6	A+	A+++	4,17
			07	05	2,44	1,96	1,00	4,40	5,20	200	1090	1300	5,04	3	5	6	A+	A+++	4,04
			10	05	2,71	1,69	1,00	4,40	5,20	200	1090	1300	5,04	3	5	6	A++	A+++	4,04
			13	05	2,98	1,42	1,00	4,40	5,20	200	1010	1280	4,68	3	5	6	A++	A+++	4,36
			07	07	2,20	2,20	1,00	4,40	5,20	200	1020	1300	4,72	3	5	6	A++	A+++	4,31
			10	07	2,47	1,93	1,00	4,40	5,20	200	1020	1280	4,72	3	5	6	A++	A+++	4,31
			13	07	2,76	1,64	1,00	4,40	5,20	200	940	1280	4,36	3	5	6	A++	A+++	4,68
			10	10	2,20	2,20	1,00	4,40	5,20	200	1020	1250	4,72	3	5	6	A++	A+++	4,31
			13	10	2,50	1,90	1,00	4,40	5,20	200	940	1250	4,36	3	5	6	A++	A+++	4,68
13	13	2,20	2,20	1,00	4,40	5,20	200	900	1220	4,18	3	5	6	A++	A+++	4,89			

**RAS-2M18G3AVG-E / TR - Performances data Bi-split size 18**

Operating status	Combination		Unit capacity (kW)		Cooling capacity (kW)			Power input (W)			Operating current (A)			Lot.10 SEER	Class	EER Nom.	
	Unit A	Unit B	Unit A	Unit B	Min.	Nom.	Max.	Min.	Nom.	Max.	Nom.	Pdc	Lot.10 SCOP				
Cooling, 230 V	1 unit operation	05	-	1,50	-	1,20	1,50	2,00	250	350	500	-	-	-	-	-	
		07	-	2,00	-	1,20	2,00	2,90	250	470	780	-	-	-	-	-	
		10	-	2,50	-	1,20	2,50	3,20	250	620	900	-	-	-	-	-	
		13	-	3,50	-	1,30	3,50	4,10	250	940	1320	-	-	-	-	-	
		16	-	4,60	-	1,30	4,60	5,00	250	1370	2060	-	-	-	-	-	
		05	05	1,50	1,50	1,50	3,00	4,80	270	570	1290	3,07	3	7	A++	5,26	
	Cooling, 230 V	2 unit operation	07	05	2,00	1,50	1,50	3,50	4,90	270	710	1300	3,42	4	8	A++	4,93
			10	05	2,50	1,50	1,50	4,00	5,60	270	880	1680	4,09	4	8	A++	4,55
			13	05	3,50	1,50	1,60	5,00	6,40	270	1250	2120	5,75	5	8	A++	4,00
			16	05	3,92	1,28	1,60	5,20	6,50	270	1340	2090	6,15	5	7	A++	3,88
			07	07	2,00	2,00	1,60	4,00	5,80	270	860	1700	4	4	8	A++	4,65
			10	07	2,50	2,00	1,60	4,50	6,40	270	1060	2110	4,9	5	8	A++	4,25
			13	07	3,31	1,89	1,60	5,20	6,50	270	1290	2100	5,93	5	8	A++	4,03
			16	07	3,62	1,58	1,60	5,20	6,50	270	1300	2110	5,97	5	8	A++	4,00
			10	10	2,50	2,50	1,60	5,00	6,40	270	1240	2110	5,71	5	8	A++	4,03
			13	10	3,03	2,17	1,60	5,20	6,50	270	1280	2100	5,89	5	8	A++	4,06
16	10	3,37	1,83	1,60	5,20	6,50	270	1260	1860	5,8	5	8	A++	4,13			
13	13	2,60	2,60	1,60	5,20	6,50	270	1240	1880	5,71	5	8	A++	4,19			
16	13	2,95	2,25	1,60	5,20	6,50	270	1210	1880	5,57	5	9	A+++	4,30			
16	16	2,60	2,60	1,60	5,20	6,50	270	1190	1880	5,48	5	9	A+++	4,37			



**RAS-2M18G3AVG-E / TR - Performances data Bi-split size 18**

Operating status	Combination		Unit capacity (kW)			Heating capacity (kW)			Power input (W)			Operating current (A)		Lot.10 SCOP	SCOP Warm climate	Average climate	Label Warm climate	COP Nom.
	Unit A	Unit B	Unit A	Unit B	Min.	Nom.	Max.	Min.	Nom.	Max.	Nom.	Pah						
1 unit operation	05	-	2.00	-	1.00	2.00	2.50	260	510	720	-	-	-	-	-	-	-	-
	07	-	2.50	-	1.00	2.50	3.60	230	680	950	-	-	-	-	-	-	-	-
	10	-	3.20	-	1.00	3.20	4.80	230	1110	1460	-	-	-	-	-	-	-	-
	13	-	4.20	-	1.10	4.20	5.30	230	1530	1810	-	-	-	-	-	-	-	-
	16	-	5.50	-	1.10	5.50	6.20	230	2340	2530	-	-	-	-	-	-	-	-
2 unit operation	05	05	2.00	2.00	1.20	4.00	5.90	240	850	1820	3.96	2	4	5	A+	A++	4.71	
	07	05	2.50	2.00	1.30	4.50	6.10	240	990	1780	4.59	3	4	5	A+	A+++	4.55	
	10	05	3.20	2.00	1.30	5.20	7.30	240	1270	2300	5.84	3	4	5	A+	A+++	4.09	
	13	05	3.79	1.81	1.30	5.60	7.80	240	1290	2490	5.93	3	5	6	A+	A+++	4.34	
	16	05	4.11	1.49	1.30	5.60	8.20	240	1280	2470	5.89	3	5	6	A++	A+++	4.38	
	07	07	2.50	2.50	1.30	5.00	7.20	240	1130	2250	5.22	3	4	6	A+	A+++	4.42	
	10	07	3.14	2.46	1.30	5.60	8.20	240	1340	2510	6.15	3	5	6	A++	A+++	4.18	
	13	07	3.51	2.09	1.30	5.60	8.20	240	1240	2440	5.71	3	5	6	A++	A+++	4.52	
	16	07	3.85	1.75	1.30	5.60	8.20	240	1220	2420	5.62	3	5	6	A++	A+++	4.59	
	10	10	2.80	2.80	1.30	5.60	8.20	240	1340	2510	6.15	3	5	6	A++	A+++	4.18	
	13	10	3.18	2.42	1.30	5.60	8.20	240	1240	2440	5.71	3	5	6	A++	A+++	4.52	
	16	10	3.54	2.06	1.30	5.60	8.20	240	1220	2420	5.62	3	5	6	A++	A+++	4.59	
	13	13	2.80	2.80	1.30	5.60	8.20	240	1150	2360	5.31	3	5	6	A++	A+++	4.87	
	16	13	3.18	2.42	1.30	5.60	8.20	240	1140	2340	5.26	3	5	6	A++	A+++	4.91	
	16	16	2.80	2.80	1.30	5.60	8.20	240	1110	2320	5.13	3	5	6	A++	A+++	5.05	

**RAS-3M18G3AVG-E / TR - Performances data Tri-split size 18**

Operating status	Combination			Unit capacity (kW)			Cooling capacity (kW)			Power input (W)			Operating current (A)		Lot.10 SEER	Class	EER Nom.
	Unit A	Unit B	Unit C	Unit A	Unit B	Unit C	Min.	Nom.	Max.	Min.	Nom.	Max.	Nom.	Pdc			
1 unit operation	05	-	-	1.50	-	-	1.20	1.50	2.00	280	350	490	-	-	-	-	-
	07	-	-	2.00	-	-	1.20	2.00	2.90	270	460	830	-	-	-	-	-
	10	-	-	2.50	-	-	1.20	2.50	3.20	270	600	940	-	-	-	-	-
	13	-	-	3.50	-	-	1.20	3.50	4.10	260	990	1230	-	-	-	-	-
	16	-	-	4.60	-	-	1.20	4.60	5.30	260	1530	2330	-	-	-	-	-
2 unit operation	05	05	-	1.50	1.50	-	1.40	3.00	4.80	360	650	1340	3.26	3	7	A++	4.62
	07	05	-	2.00	1.50	-	1.60	3.50	4.90	350	770	1380	3.6	4	7	A++	4.54
	10	05	-	2.50	1.50	-	1.60	4.00	5.60	350	940	1590	4.36	4	7	A++	4.27
	13	05	-	3.50	1.50	-	1.60	5.00	6.40	340	1360	2410	6.24	5	7	A++	3.69
	16	05	-	3.92	1.28	-	1.60	5.20	6.50	340	1470	2440	6.73	5	7	A++	3.56
	07	07	-	2.00	2.00	-	1.60	4.00	5.80	350	920	1600	4.27	4	7	A++	4.36
	10	07	-	2.50	2.00	-	1.60	4.50	6.40	350	1120	2450	5.17	5	7	A++	4.01
	13	07	-	3.31	1.89	-	1.60	5.20	6.50	340	1420	2430	6.51	5	7	A++	3.65
	16	07	-	3.62	1.58	-	1.60	5.20	6.50	340	1400	2430	6.42	5	7	A++	3.71
	10	10	-	2.50	2.50	-	1.60	5.00	6.40	350	1370	2430	6.29	5	7	A++	3.64
	13	10	-	3.03	2.17	-	1.70	5.20	6.50	340	1420	2460	6.51	5	7	A++	3.65
	16	10	-	3.37	1.83	-	1.70	5.20	6.50	340	1400	2460	6.42	5	7	A++	3.71
	13	13	-	2.60	2.60	-	1.70	5.20	6.60	330	1340	2460	6.15	5	7	A++	3.87
	16	13	-	2.95	2.25	-	1.70	5.20	6.70	330	1330	2430	6.11	5	7	A++	3.92
	16	16	-	2.60	2.60	-	1.70	5.20	6.70	330	1310	2460	6.02	5	8	A++	3.98
	3 unit operation	05	05	05	1.50	1.50	1.50	1.70	4.50	6.00	300	830	1480	3.87	5	8	A++
07		05	05	2.00	1.50	1.50	1.70	5.00	6.90	300	980	1990	4.54	5	9	A+++	5.11
10		05	05	2.36	1.42	1.42	1.70	5.20	7.50	300	1050	2480	4.86	5	8	A++	4.96
13		05	05	2.80	1.20	1.20	1.70	5.20	7.50	300	1020	2490	4.72	5	9	A+++	5.07
16		05	05	3.15	1.03	1.03	1.90	5.20	7.50	300	1030	2530	4.77	5	8	A++	5.06
07		07	05	1.89	1.89	1.42	1.90	5.20	7.50	300	1040	2510	4.81	5	9	A+++	5.00
10		07	05	2.17	1.73	1.30	1.90	5.20	7.50	300	1040	2510	4.81	5	9	A+++	5.00
13		07	05	2.60	1.49	1.11	1.90	5.20	7.50	300	1010	2490	4.68	5	9	A+++	5.11
16		07	05	2.95	1.28	0.96	2.00	5.20	7.50	300	1000	2480	4.63	5	9	A+++	5.17
10		10	05	2.00	2.00	1.20	2.00	5.20	7.50	300	1040	2490	4.81	5	9	A+++	5.00
13		10	05	2.43	1.73	1.04	2.00	5.20	7.50	300	1010	2490	4.68	5	9	A+++	5.11
16		10	05	2.78	1.51	0.91	2.00	5.20	7.50	300	1010	2460	4.68	5	9	A+++	5.17
13		13	05	2.14	2.14	0.92	2.00	5.20	7.50	300	990	2460	4.59	5	9	A+++	5.20
16		13	05	2.49	1.90	0.81	2.00	5.20	7.50	300	990	2490	4.59	5	9	A+++	5.27
07		07	07	1.73	1.73	1.73	2.00	5.20	7.50	300	1020	2460	4.72	5	9	A+++	5.12
10		07	07	2.00	1.60	1.60	2.00	5.20	7.50	300	1020	2460	4.72	5	9	A+++	5.12
13		07	07	2.43	1.39	1.39	2.00	5.20	7.50	300	1000	2430	4.63	5	9	A+++	5.22
16		07	07	2.78	1.21	1.21	2.00	5.20	7.50	300	1000	2420	4.63	5	9	A+++	5.20
10		10	07	1.86	1.86	1.49	2.00	5.20	7.50	300	1020	2470	4.72	5	9	A+++	5.12
13		10	07	2.28	1.63	1.30	2.00	5.20	7.50	300	990	2470	4.59	5	9	A+++	5.22
16		10	07	2.63	1.43	1.14	2.00	5.20	7.50	300	1000	2440	4.63	5	9	A+++	5.20
13		13	07	2.02	2.02	1.16	2.00	5.20	7.50	300	990	2430	4.59	5	9	A+++	5.22
16		13	07	2.37	1.80	1.03	2.00	5.20	7.50	300	980	2470	4.54	5	9	A+++	5.28
10		10	10	1.73	1.73	1.73	2.00	5.20	7.50	300	1020	2440	4.72	5	9	A+++	5.12
13		10	10	2.14	1.53	1.53	2.00	5.20	7.50	300	1000	2430	4.63	5	9	A+++	5.22
16		10	10	2.49	1.35	1.35	2.00	5.20	7.50	300	1000	2400	4.63	5	9	A+++	5.20
13		13	10	1.92	1.92	1.37	2.00	5.20	7.50	300	990	2380	4.59	5	9	A+++	5.22

RESIDENTIAL AIR-TO-AIR



**RAS-3M18G3AVG-E / TR - Performances data Tri-split size 18**

Operating status	Combination			Unit capacity (kW)			Heating capacity (kW)			Power input (W)			Operating current (A)		Lot.10	SCOP	Average climate	Label	Warm climate	COP
	Unit A	Unit B	Unit C	Unit A	Unit B	Unit C	Min.	Nom.	Max.	Min.	Nom.	Max.	Nom.	Pch	SCOP	Warm climate	climate	climate	Nom.	
1 unit operation	05	-	-	2.00	-	-	1.00	2.00	2.50	260	820	1170	-	-	-	-	-	-	-	-
	07	-	-	2.50	-	-	1.10	2.50	3.60	270	1090	1480	-	-	-	-	-	-	-	-
	10	-	-	3.20	-	-	1.10	3.20	4.80	270	1320	1860	-	-	-	-	-	-	-	-
	13	-	-	4.20	-	-	1.20	4.20	5.30	270	1560	1970	-	-	-	-	-	-	-	-
	16	-	-	5.50	-	-	1.30	5.50	6.50	270	1980	2330	-	-	-	-	-	-	-	-
2 unit operation	05	05	-	2.00	2.00	-	1.60	4.00	6.10	300	1120	1930	5.17	2	4	6	A+	A+++	3.57	
	07	05	-	2.50	2.00	-	1.60	4.50	6.10	300	1270	1880	5.84	2	4	6	A+	A+++	3.54	
	10	05	-	3.20	2.00	-	1.60	5.20	7.30	300	1520	2320	6.95	3	4	6	A+	A+++	3.42	
	13	05	-	4.20	2.00	-	1.80	6.20	7.80	340	1850	2400	8.41	3	4	6	A+	A+++	3.35	
	16	05	-	4.99	1.81	-	1.90	6.80	8.20	340	2080	2380	9.43	4	4	6	A+	A+++	3.27	
	07	07	-	2.50	2.50	-	1.80	5.00	7.20	340	1410	2260	6.46	3	4	6	A+	A+++	3.55	
	10	07	-	3.20	2.50	-	1.80	5.70	8.20	340	1650	2420	7.53	3	4	6	A+	A+++	3.45	
	13	07	-	4.20	2.50	-	1.90	6.70	8.20	340	2000	2340	9.07	3	4	6	A+	A+++	3.35	
	16	07	-	4.68	2.13	-	1.90	6.80	8.20	340	2040	2330	9.25	4	4	6	A+	A+++	3.33	
	10	10	-	3.20	3.20	-	1.90	6.40	8.20	340	1920	2420	8.72	3	5	6	A++	A+++	3.33	
	13	10	-	3.86	2.94	-	1.90	6.80	8.20	340	2050	2340	9.30	4	5	6	A++	A+++	3.32	
	16	10	-	4.30	2.50	-	1.90	6.80	8.20	340	2040	2330	9.25	4	5	6	A++	A+++	3.33	
	13	13	-	3.40	3.40	-	1.90	6.80	8.20	340	2020	2280	9.16	4	5	6	A++	A+++	3.37	
16	13	-	3.86	2.94	-	1.90	6.80	8.20	340	2010	2260	9.12	4	5	6	A++	A+++	3.38		
16	16	-	3.40	3.40	-	1.90	6.80	8.20	340	1990	2240	9.03	4	5	6	A++	A+++	3.42		
3 unit operation	05	05	05	2.00	2.00	2.00	1.90	6.00	7.50	350	1380	1990	6.33	3	5	6	A++	A+++	4.35	
	07	05	05	2.50	2.00	2.00	1.90	6.50	8.30	350	1510	2010	6.91	3	5	6	A++	A+++	4.30	
	10	05	05	3.02	1.89	1.89	1.90	6.80	8.30	350	1620	2010	7.39	4	5	6	A++	A+++	4.20	
	13	05	05	3.48	1.66	1.66	1.90	6.80	8.30	350	1570	1970	7.17	4	5	6	A++	A+++	4.33	
	16	05	05	3.94	1.43	1.43	1.90	6.80	8.30	350	1520	1960	6.95	4	5	6	A++	A+++	4.47	
	07	07	05	2.43	2.43	1.94	1.90	6.80	8.30	350	1600	1980	7.30	4	5	6	A++	A+++	4.25	
	10	07	05	2.83	2.21	1.77	1.90	6.80	8.30	350	1600	1980	7.30	4	5	6	A++	A+++	4.25	
	13	07	05	3.28	1.95	1.56	1.90	6.80	8.30	360	1510	1940	6.91	4	5	6	A++	A+++	4.50	
	16	07	05	3.74	1.70	1.36	1.90	6.80	8.30	360	1510	1930	6.91	4	5	6	A++	A+++	4.50	
	10	10	05	2.59	2.59	1.62	1.90	6.80	8.30	350	1600	1980	7.30	4	5	6	A++	A+++	4.25	
	13	10	05	3.04	2.31	1.45	1.90	6.80	8.30	360	1510	1940	6.91	4	5	6	A++	A+++	4.50	
	16	10	05	3.50	2.03	1.27	1.90	6.80	8.30	360	1510	1930	6.91	4	5	6	A++	A+++	4.50	
	13	13	05	2.75	2.75	1.31	1.90	6.80	8.30	360	1440	1900	6.60	4	5	6	A++	A+++	4.72	
	16	13	05	3.20	2.44	1.16	1.90	6.80	8.30	360	1410	1890	6.46	4	5	6	A++	A+++	4.82	
	07	07	07	2.27	2.27	2.27	1.90	6.80	8.30	360	1520	1950	6.95	4	5	6	A++	A+++	4.47	
	10	07	07	2.65	2.07	2.07	1.90	6.80	8.30	360	1520	1950	6.95	4	5	6	A++	A+++	4.47	
	13	07	07	3.10	1.85	1.85	1.90	6.80	8.30	360	1460	1910	6.68	4	5	6	A++	A+++	4.66	
	16	07	07	3.56	1.62	1.62	1.90	6.80	8.30	360	1440	1900	6.60	4	5	6	A++	A+++	4.72	
	10	10	07	2.44	2.44	1.91	1.90	6.80	8.20	360	1520	1950	6.95	4	5	6	A++	A+++	4.47	
	13	10	07	2.88	2.20	1.72	1.90	6.80	8.30	360	1460	1910	6.68	4	5	6	A++	A+++	4.66	
16	10	07	3.34	1.94	1.52	1.90	6.80	8.30	360	1440	1900	6.60	4	5	6	A++	A+++	4.72		
13	13	07	2.62	2.62	1.56	1.90	6.80	8.30	370	1370	1880	6.29	4	5	6	A++	A+++	4.96		
16	13	07	3.07	2.34	1.39	1.90	6.80	8.30	370	1370	1870	6.29	4	5	6	A++	A+++	4.96		
10	10	10	2.27	2.27	2.27	1.90	6.80	8.30	370	1520	1950	6.95	4	5	6	A++	A+++	4.47		
13	10	10	2.69	2.05	2.05	1.90	6.80	8.30	370	1460	1910	6.68	4	5	6	A++	A+++	4.66		
16	10	10	3.14	1.83	1.83	1.90	6.80	8.30	370	1450	1900	6.64	4	5	6	A++	A+++	4.69		
13	13	10	2.46	2.46	1.88	1.90	6.80	8.30	370	1370	1880	6.29	4	5	6	A++	A+++	4.96		

**RAS-3M26G3AVG-E / TR - Performances in Cooling mode**

Operating Status	Combination			Unit capacity (kW)			Cooling capacity (kW)			Power input (W)			Operating current (A)		Lot.10	SEER	Class	EER
	Unit A	Unit B	Unit C	Unit A	Unit B	Unit C	Min.	Nom.	Max.	Min.	Nom.	Max.	Nom.	Pdc	SEER	SEER	Class	Nom.
1 unit operation	05	-	-	1.50	-	-	1.3	1.5	2.0	350	350	360	-	-	-	-	-	-
	07	-	-	2.00	-	-	1.4	2.0	2.9	350	480	610	-	-	-	-	-	-
	10	-	-	2.50	-	-	1.4	2.5	3.2	350	610	700	-	-	-	-	-	-
	13	-	-	3.50	-	-	1.6	3.5	4.1	350	860	950	-	-	-	-	-	-
	16	-	-	4.60	-	-	1.7	4.6	5.3	350	1140	1280	-	-	-	-	-	-
	18	-	-	5.00	-	-	1.8	5.0	6.0	350	1250	1470	-	-	-	-	-	-
	22	-	-	6.10	-	-	1.9	6.1	6.7	350	1530	1670	-	-	-	-	-	-
	24	-	-	7.00	-	-	2.0	7.0	7.7	350	1750	1940	-	-	-	-	-	-
2 units operation	05	05	-	1.50	1.50	-	1.5	3.0	4.0	350	740	920	3.46	3.0	6.90	A++	4.05	
	07	05	-	2.00	1.50	-	1.6	3.5	4.9	350	860	1170	4.00	3.5	7.20	A++	4.07	
	10	05	-	2.50	1.50	-	1.6	4.0	5.2	350	990	1250	4.59	4.0	7.40	A++	4.04	
	13	05	-	3.50	1.50	-	1.8	5.0	6.1	350	1250	1500	5.75	5.0	7.80	A++	4.00	
	16	05	-	4.60	1.50	-	1.9	6.1	7.3	350	1530	1830	6.99	6.1	8.30	A++	3.99	
	18	05	-	5.00	1.50	-	1.9	6.5	8.0	350	1630	2030	7.44	6.5	8.40	A++	3.99	
	22	05	-	5.62	1.38	-	2.0	7.0	8.7	350	1750	2220	7.97	7.0	8.60	A+++	4.00	
	24	05	-	5.76	1.24	-	2.0	7.0	9.0	350	1750	2300	7.97	7.0	8.60	A+++	4.00	
	07	07	-	2.00	2.00	-	1.6	4.0	5.8	350	990	1420	4.59	4.0	7.40	A++	4.04	
	10	07	-	2.50	2.00	-	1.7	4.5	6.1	350	1120	1500	5.17	4.5	7.50	A++	4.02	
	13	07	-	3.50	2.00	-	1.8	5.5	7.0	350	1370	1750	6.29	5.5	8.00	A++	4.01	
	16	07	-	4.60	2.00	-	2.0	6.6	8.2	350	1650	2080	7.53	6.6	8.50	A+++	4.00	
	18	07	-	5.00	2.00	-	2.0	7.0	8.9	350	1750	2280	7.97	7.0	8.60	A+++	4.00	
	22	07	-	5.27	1.73	-	2.0	7.0	9.0	350	1750	2300	7.97	7.0	8.60	A+++	4.00	
	24	07	-	5.44	1.56	-	2.0	7.0	9.0	350	1750	2300	7.97	7.0	8.60	A+++	4.00	
	10	10	-	2.50	2.50	-	1.8	5.0	6.4	350	1250	1580	5.75	5.0	7.80	A++	4.00	
	13	10	-	3.50	2.50	-	1.9	6.0	7.3	350	1500	1830	6.86	6.0	8.20	A++	4.00	
	16	10	-	4.54	2.46	-	2.0	7.0	8.5	350	1750	2170	7.97	7.0	8.60	A+++	4.00	
	18	10	-	4.67	2.33	-	2.0	7.0	9.0	350	1750	2300	7.97	7.0	8.60	A+++	4.00	
	22	10	-	4.97	2.03	-	2.0	7.0	9.0	350	1750	2300	7.97	7.0	8.60	A+++	4.00	
	24	10	-	5.16	1.84	-	2.0	7.0	9.0	350	1750	2300	7.97	7.0	8.60	A+++	4.00	
	13	13	-	3.50	3.50	-	2.0	7.0	8.2	350	1750	2080	7.97	7.0	8.60	A+++	4.00	
	16	13	-	3.98	3.02	-	2.0	7.0	9.0	350	1750	2300	7.97	7.0	8.60	A+++	4.00	
	18	13	-	4.12	2.88	-	2.0	7.0										

**RAS-3M26G3AVG-E / TR - Performances in Cooling mode**

Operating Status	Combination			Unit capacity (kW)			Cooling capacity (kW)			Power input (W)			Operating current (A)			Lot.10 SEER	Class	EER Nom.
	Unit A	Unit B	Unit C	Unit A	Unit B	Unit C	Min.	Nom.	Max.	Min.	Nom.	Max.	Min.	Nom.	Pdc			
Cooling, 230 V	3 units operation	05	05	05	1.50	1.50	1.50	1.7	4.5	6.0	350	1120	1470	5.17	4.5	7.40	A++	4.02
		07	05	05	2.00	1.50	1.50	1.8	5.0	6.9	350	1250	1720	5.75	5.0	7.60	A++	4.00
		10	05	05	2.50	1.50	1.50	1.8	5.5	7.2	350	1370	1810	6.29	5.5	7.80	A++	4.01
		13	05	05	3.50	1.50	1.50	1.9	6.5	8.1	350	1630	2060	7.44	6.5	8.30	A++	3.99
		16	05	05	4.24	1.38	1.38	2.0	7.0	9.0	350	1750	2300	7.97	7.0	8.50	A+++	4.00
		18	05	05	4.38	1.31	1.31	2.0	7.0	9.0	350	1750	2300	7.97	7.0	8.50	A+++	4.00
		22	05	05	4.69	1.15	1.15	2.0	7.0	9.0	350	1750	2300	7.97	7.0	8.50	A+++	4.00
		24	05	05	4.90	1.05	1.05	2.0	7.0	9.0	350	1750	2300	7.97	7.0	8.50	A+++	4.00
		07	07	05	2.00	2.00	1.50	1.8	5.5	7.8	350	1370	1970	6.29	5.5	7.80	A++	4.01
		10	07	05	2.50	2.00	1.50	1.9	6.0	8.1	350	1500	2060	6.86	6.0	8.10	A++	4.00
		13	07	05	3.50	2.00	1.50	2.0	7.0	9.0	350	1750	2300	7.97	7.0	8.50	A+++	4.00
		16	07	05	3.98	1.73	1.30	2.0	7.0	9.0	350	1750	2300	7.97	7.0	8.50	A+++	4.00
		18	07	05	4.12	1.65	1.24	2.0	7.0	9.0	350	1750	2300	7.97	7.0	8.50	A+++	4.00
		22	07	05	4.45	1.46	1.09	2.0	7.0	9.0	350	1750	2300	7.97	7.0	8.50	A+++	4.00
		24	07	05	4.67	1.33	1.00	2.0	7.0	9.0	350	1750	2300	7.97	7.0	8.50	A+++	4.00
		10	10	05	2.50	2.50	1.50	1.9	6.5	8.4	350	1630	2140	7.44	6.5	8.30	A++	3.99
		13	10	05	3.27	2.33	1.40	2.0	7.0	9.0	350	1750	2300	7.97	7.0	8.50	A+++	4.00
		16	10	05	3.74	2.03	1.22	2.0	7.0	9.0	350	1750	2300	7.97	7.0	8.50	A+++	4.00
		18	10	05	3.89	1.94	1.17	2.0	7.0	9.0	350	1750	2300	7.97	7.0	8.50	A+++	4.00
		22	10	05	4.23	1.73	1.04	2.0	7.0	9.0	350	1750	2300	7.97	7.0	8.50	A+++	4.00
		24	10	05	4.45	1.59	0.95	2.0	7.0	9.0	350	1750	2300	7.97	7.0	8.50	A+++	4.00
		13	13	05	2.88	2.88	1.24	2.0	7.0	9.0	350	1750	2300	7.97	7.0	8.50	A+++	4.00
		16	13	05	3.35	2.55	1.09	2.0	7.0	9.0	350	1750	2300	7.97	7.0	8.50	A+++	4.00
		18	13	05	3.50	2.45	1.05	2.0	7.0	9.0	350	1750	2300	7.97	7.0	8.50	A+++	4.00
		22	13	05	3.85	2.21	0.95	2.0	7.0	9.0	350	1750	2300	7.97	7.0	8.50	A+++	4.00
		24	13	05	4.08	2.04	0.88	2.0	7.0	9.0	350	1750	2300	7.97	7.0	8.50	A+++	4.00
		16	16	05	3.01	3.01	0.98	2.0	7.0	9.0	350	1750	2300	7.97	7.0	8.50	A+++	4.00
		18	16	05	3.15	2.90	0.95	2.0	7.0	9.0	350	1750	2300	7.97	7.0	8.50	A+++	4.00
		22	16	05	3.50	2.64	0.86	2.0	7.0	9.0	350	1750	2300	7.97	7.0	8.50	A+++	4.00
		24	16	05	3.74	2.46	0.80	2.0	7.0	9.0	350	1750	2300	7.97	7.0	8.50	A+++	4.00
		07	07	07	2.00	2.00	2.00	1.9	6.0	8.7	350	1500	2220	6.86	6.0	8.10	A++	4.00
		10	07	07	2.50	2.00	2.00	1.9	6.5	9.0	350	1630	2300	7.44	6.5	8.30	A++	3.99
		13	07	07	3.27	1.87	1.87	2.0	7.0	9.0	350	1750	2300	7.97	7.0	8.50	A+++	4.00
		16	07	07	3.74	1.63	1.63	2.0	7.0	9.0	350	1750	2300	7.97	7.0	8.50	A+++	4.00
		18	07	07	3.89	1.56	1.56	2.0	7.0	9.0	350	1750	2300	7.97	7.0	8.50	A+++	4.00
		22	07	07	4.23	1.39	1.39	2.0	7.0	9.0	350	1750	2300	7.97	7.0	8.50	A+++	4.00
		24	07	07	4.45	1.27	1.27	2.0	7.0	9.0	350	1750	2300	7.97	7.0	8.50	A+++	4.00
		10	10	07	2.50	2.50	2.00	2.0	7.0	9.0	350	1750	2300	7.97	7.0	8.50	A+++	4.00
		13	10	07	3.06	2.19	1.75	2.0	7.0	9.0	350	1750	2300	7.97	7.0	8.50	A+++	4.00
		16	10	07	3.54	1.92	1.54	2.0	7.0	9.0	350	1750	2300	7.97	7.0	8.50	A+++	4.00
18	10	07	3.68	1.84	1.47	2.0	7.0	9.0	350	1750	2300	7.97	7.0	8.50	A+++	4.00		
22	10	07	4.03	1.65	1.32	2.0	7.0	9.0	350	1750	2300	7.97	7.0	8.50	A+++	4.00		
24	10	07	4.26	1.52	1.22	2.0	7.0	9.0	350	1750	2300	7.97	7.0	8.50	A+++	4.00		
13	13	07	2.72	2.72	1.56	2.0	7.0	9.0	350	1750	2300	7.97	7.0	8.50	A+++	4.00		
16	13	07	3.19	2.43	1.39	2.0	7.0	9.0	350	1750	2300	7.97	7.0	8.50	A+++	4.00		
18	13	07	3.33	2.33	1.33	2.0	7.0	9.0	350	1750	2300	7.97	7.0	8.50	A+++	4.00		
22	13	07	3.68	2.11	1.21	2.0	7.0	9.0	350	1750	2300	7.97	7.0	8.50	A+++	4.00		
24	13	07	3.92	1.96	1.12	2.0	7.0	9.0	350	1750	2300	7.97	7.0	8.50	A+++	4.00		
16	16	07	2.88	2.88	1.25	2.0	7.0	9.0	350	1750	2300	7.97	7.0	8.50	A+++	4.00		
18	16	07	3.02	2.78	1.21	2.0	7.0	9.0	350	1750	2300	7.97	7.0	8.50	A+++	4.00		
22	16	07	3.36	2.54	1.10	2.0	7.0	9.0	350	1750	2300	7.97	7.0	8.50	A+++	4.00		
24	16	07	3.60	2.37	1.03	2.0	7.0	9.0	350	1750	2300	7.97	7.0	8.50	A+++	4.00		
10	10	10	2.33	2.33	2.33	2.0	7.0	9.0	350	1750	2300	7.97	7.0	8.50	A+++	4.00		
13	10	10	2.88	2.06	2.06	2.0	7.0	9.0	350	1750	2300	7.97	7.0	8.50	A+++	4.00		
16	10	10	3.35	1.82	1.82	2.0	7.0	9.0	350	1750	2300	7.97	7.0	8.50	A+++	4.00		
18	10	10	3.50	1.75	1.75	2.0	7.0	9.0	350	1750	2300	7.97	7.0	8.50	A+++	4.00		
22	10	10	3.85	1.58	1.58	2.0	7.0	9.0	350	1750	2300	7.97	7.0	8.50	A+++	4.00		
24	10	10	4.08	1.46	1.46	2.0	7.0	9.0	350	1750	2300	7.97	7.0	8.50	A+++	4.00		
13	13	10	2.58	2.58	1.84	2.0	7.0	9.0	350	1750	2300	7.97	7.0	8.50	A+++	4.00		
16	13	10	3.04	2.31	1.65	2.0	7.0	9.0	350	1750	2300	7.97	7.0	8.50	A+++	4.00		
18	13	10	3.18	2.23	1.59	2.0	7.0	9.0	350	1750	2300	7.97	7.0	8.50	A+++	4.00		
22	13	10	3.53	2.02	1.45	2.0	7.0	9.0	350	1750	2300	7.97	7.0	8.50	A+++	4.00		
24	13	10	3.77	1.88	1.35	2.0	7.0	9.0	350	1750	2300	7.97	7.0	8.50	A+++	4.00		
16	16	10	2.75	2.75	1.50	2.0	7.0	9.0	350	1750	2300	7.97	7.0	8.50	A+++	4.00		
18	16	10	2.89	2.66	1.45	2.0	7.0	9.0	350	1750	2300	7.97	7.0	8.50	A+++	4.00		
22	16	10	3.23	2.44	1.33	2.0	7.0	9.0	350	1750	2300	7.97	7.0	8.50	A+++	4.00		
24	16	10	3.48	2.28	1.24	2.0	7.0	9.0	350	1750	2300	7.97	7.0	8.50	A+++	4.00		
13	13	13	2.33	2.33	2.33	2.0	7.0	9.0	350	1750	2300	7.97	7.0	8.50	A+++	4.00		
16	13	13	2.78	2.11	2.11	2.0	7.0	9.0	350	1750	2300	7.97	7.0	8.50	A+++	4.00		
18	13	13	2.92	2.04	2.04	2.0	7.0	9.0	350	1750	2300	7.97	7.0	8.50	A+++	4.00		
22	13	13	3.26	1.87	1.87	2.0	7.0	9.0	350	1750	2300	7.97	7.0	8.50	A+++	4.00		
24	13	13	3.50	1.75	1.75	2.0	7.0	9.0	350	1750	2300	7.97	7.0	8.50	A+++	4.00		
16	16	13	2.54	2.54	1.93	2.0	7.0	9.0	350	1750	2300	7.97	7.0	8.50	A+++	4.00		
18	16	13	2.67	2.46	1.87	2.0	7.0	9.0	350	1750	2300	7.97	7.0	8.50	A+++	4.00		
22	16	13	3.01	2.27	1.73	2.0	7.0	9.0	350	1750	2300	7.97	7.0	8.50	A+++	4.00		
24	16	13	3.25	2.13	1.62	2.0	7.0	9.0	350	1750	2300	7.97	7.0	8.50	A+++	4.00		
16	16	16	2.33	2.33	2.33	2.0	7.0	9.0	350	1750	2300	7.97	7.0	8.50	A+++	4.00		
18	16	16	2.46	2.27	2.27	2.0	7.0	9.0	350	1750	2300	7.97	7.0	8.50	A+++	4.00		
22	16	16	2.79	2.10	2.10	2.0	7.0	9.0	350	1750	2300	7.97	7.0	8.50	A+++	4.00		

RESIDENTIAL AIR-TO-AIR





**RAS-3M26G3AVG-E / TR - Performances in Heating mode**

Operating Status	Combination			Unit capacity (kW)			Heating capacity (kW)			Power input (W)			Operating current (A)		Loi.10 SCOP Warm climate	Average climate	Label Warm climate	COP Nom.
	Unit A	Unit B	Unit C	Unit A	Unit B	Unit C	Min.	Nom.	Max.	Min.	Nom.	Max.	Nom.	Ph				
1 unit operation	05	-	-	2.00	-	-	1.2	2.0	2.5	300	560	750	-	-	-	-	-	-
	07	-	-	2.50	-	-	1.3	2.5	3.6	310	670	1020	-	-	-	-	-	-
	10	-	-	3.20	-	-	1.4	3.2	4.8	320	820	1300	-	-	-	-	-	-
	13	-	-	4.20	-	-	1.5	4.2	5.3	320	1040	1420	-	-	-	-	-	-
	16	-	-	5.50	-	-	1.6	5.5	6.5	340	1320	1710	-	-	-	-	-	-
	18	-	-	6.00	-	-	1.7	6.0	6.5	340	1420	1710	-	-	-	-	-	-
	22	-	-	7.00	-	-	1.8	7.0	7.5	350	1640	1950	-	-	-	-	-	-
	24	-	-	8.00	-	-	1.9	8.0	8.8	360	1850	2260	-	-	-	-	-	-
	05	05	-	2.00	2.00	-	1.4	4.0	5.0	320	990	1350	4.59	2.4	4.10	5.50	A+	A+++
07	05	-	2.50	2.00	-	1.5	4.5	6.1	330	1100	1610	5.08	2.7	4.20	5.50	A+	A+++	4.09
10	05	-	3.20	2.00	-	1.6	5.2	7.3	330	1250	1900	5.75	3.1	4.30	5.60	A+	A+++	4.16
13	05	-	4.20	2.00	-	1.7	6.2	7.8	340	1470	2020	6.73	3.7	4.30	5.40	A+	A+++	4.22
16	05	-	5.50	2.00	-	1.9	7.5	9.0	350	1750	2310	7.97	4.5	4.40	5.40	A+	A+++	4.29
18	05	-	6.00	2.00	-	1.9	8.0	9.0	360	1850	2310	8.41	4.8	4.50	5.50	A+	A+++	4.32
22	05	-	6.77	1.93	-	2.0	8.7	10.0	360	2000	2550	9.07	5.2	4.60	5.60	A++	A+++	4.35
24	05	-	6.96	1.74	-	2.0	8.7	11.3	360	2000	2860	9.07	5.2	4.60	5.60	A++	A+++	4.35
07	07	-	2.50	2.50	-	1.6	5.0	7.2	330	1210	1880	5.57	3.0	4.30	5.50	A+	A+++	4.13
10	07	-	3.20	2.50	-	1.7	5.7	8.4	340	1360	2160	6.24	3.4	4.30	5.50	A+	A+++	4.19
13	07	-	4.20	2.50	-	1.8	6.7	8.9	350	1580	2280	7.22	4.0	4.40	5.40	A+	A+++	4.24
16	07	-	5.50	2.50	-	1.9	8.0	10.1	360	1850	2570	8.41	4.8	4.50	5.50	A+	A+++	4.32
18	07	-	6.00	2.50	-	2.0	8.5	10.1	360	1960	2570	8.90	5.1	4.50	5.60	A+	A+++	4.34
22	07	-	6.41	2.29	-	2.0	8.7	11.1	360	2000	2810	9.07	5.2	4.60	5.60	A++	A+++	4.35
24	07	-	6.63	2.07	-	2.0	8.7	11.5	360	2000	2900	9.07	5.2	4.60	5.60	A++	A+++	4.35
10	10	-	3.20	3.20	-	1.7	6.4	9.6	340	1510	2450	6.91	3.8	4.40	5.40	A+	A+++	4.24
13	10	-	4.20	3.20	-	1.9	7.4	10.1	350	1730	2570	7.88	4.4	4.40	5.40	A+	A+++	4.28
16	10	-	5.50	3.20	-	2.0	8.7	11.3	360	2000	2860	9.07	5.2	4.60	5.60	A++	A+++	4.35
18	10	-	5.67	3.03	-	2.0	8.7	11.3	360	2000	2860	9.07	5.2	4.60	5.60	A++	A+++	4.35
22	10	-	5.97	2.73	-	2.0	8.7	11.5	360	2000	2900	9.07	5.2	4.60	5.60	A++	A+++	4.35
24	10	-	6.21	2.49	-	2.0	8.7	11.5	360	2000	2900	9.07	5.2	4.60	5.60	A++	A+++	4.35
13	13	-	4.20	4.20	-	2.0	8.4	10.6	360	1940	2690	8.81	5.0	4.50	5.60	A+	A+++	4.33
16	13	-	4.93	3.77	-	2.0	8.7	11.5	360	2000	2900	9.07	5.2	4.60	5.60	A++	A+++	4.35
18	13	-	5.12	3.58	-	2.0	8.7	11.5	360	2000	2900	9.07	5.2	4.60	5.60	A++	A+++	4.35
22	13	-	5.44	3.26	-	2.0	8.7	11.5	360	2000	2900	9.07	5.2	4.60	5.60	A++	A+++	4.35
24	13	-	5.70	3.00	-	2.0	8.7	11.5	360	2000	2900	9.07	5.2	4.60	5.60	A++	A+++	4.35
16	16	-	4.35	4.35	-	2.0	8.7	11.5	360	2000	2900	9.07	5.2	4.60	5.60	A++	A+++	4.35
18	16	-	4.54	4.16	-	2.0	8.7	11.5	360	2000	2900	9.07	5.2	4.60	5.60	A++	A+++	4.35
22	16	-	4.87	3.83	-	2.0	8.7	11.5	360	2000	2900	9.07	5.2	4.60	5.60	A++	A+++	4.35
24	16	-	5.16	3.54	-	2.0	8.7	11.5	360	2000	2900	9.07	5.2	4.60	5.60	A++	A+++	4.35
18	18	-	4.35	4.35	-	2.0	8.7	11.5	360	2000	2900	9.07	5.2	4.60	5.60	A++	A+++	4.35
22	18	-	4.68	4.02	-	2.0	8.7	11.5	360	2000	2900	9.07	5.2	4.60	5.60	A++	A+++	4.35
24	18	-	4.97	3.73	-	2.0	8.7	11.5	360	2000	2900	9.07	5.2	4.60	5.60	A++	A+++	4.35
05	05	05	2.00	2.00	2.00	1.7	6.0	7.5	340	1420	1950	6.51	3.6	4.50	5.50	A+	A+++	4.23
07	05	05	2.50	2.00	2.00	1.7	6.5	8.6	350	1530	2210	6.99	3.9	4.50	5.50	A+	A+++	4.25
10	05	05	3.20	2.00	2.00	1.8	7.2	9.8	350	1680	2500	7.66	4.3	4.50	5.50	A+	A+++	4.29
13	05	05	4.20	2.00	2.00	2.0	8.2	10.3	360	1900	2620	8.63	4.9	4.50	5.50	A+	A+++	4.32
16	05	05	5.04	1.83	1.83	2.0	8.7	11.5	360	2000	2900	9.07	5.2	4.60	5.60	A++	A+++	4.35
18	05	05	5.22	1.74	1.74	2.0	8.7	11.5	360	2000	2900	9.07	5.2	4.60	5.60	A++	A+++	4.35
22	05	05	5.54	1.58	1.58	2.0	8.7	11.5	360	2000	2900	9.07	5.2	4.60	5.60	A++	A+++	4.35
24	05	05	5.80	1.45	1.45	2.0	8.7	11.5	360	2000	2900	9.07	5.2	4.60	5.60	A++	A+++	4.35
07	07	05	2.50	2.50	2.00	1.8	7.0	9.7	350	1640	2470	7.48	4.2	4.50	5.50	A+	A+++	4.27
10	07	05	3.20	2.50	2.00	1.9	7.7	10.9	360	1790	2760	8.14	4.6	4.50	5.40	A+	A+++	4.30
13	07	05	4.20	2.50	2.00	2.0	8.7	11.4	360	2000	2880	9.07	5.2	4.60	5.60	A++	A+++	4.35
16	07	05	4.79	2.18	1.74	2.0	8.7	11.5	360	2000	2900	9.07	5.2	4.60	5.60	A++	A+++	4.35
18	07	05	4.97	2.07	1.66	2.0	8.7	11.5	360	2000	2900	9.07	5.2	4.60	5.60	A++	A+++	4.35
22	07	05	5.30	1.89	1.51	2.0	8.7	11.5	360	2000	2900	9.07	5.2	4.60	5.60	A++	A+++	4.35
24	07	05	5.57	1.74	1.39	2.0	8.7	11.5	360	2000	2900	9.07	5.2	4.60	5.60	A++	A+++	4.35
10	10	05	3.20	3.20	2.00	2.0	8.4	11.5	360	1940	2900	8.81	5.0	4.50	5.50	A+	A+++	4.33
13	10	05	3.89	2.96	1.85	2.0	8.7	11.5	360	2000	2900	9.07	5.2	4.60	5.60	A++	A+++	4.35
16	10	05	4.47	2.60	1.63	2.0	8.7	11.5	360	2000	2900	9.07	5.2	4.60	5.60	A++	A+++	4.35
18	10	05	4.66	2.49	1.55	2.0	8.7	11.5	360	2000	2900	9.07	5.2	4.60	5.60	A++	A+++	4.35
22	10	05	4.99	2.28	1.43	2.0	8.7	11.5	360	2000	2900	9.07	5.2	4.60	5.60	A++	A+++	4.35
24	10	05	5.27	2.11	1.32	2.0	8.7	11.5	360	2000	2900	9.07	5.2	4.60	5.60	A++	A+++	4.35
13	13	05	3.51	3.51	1.67	2.0	8.7	11.5	360	2000	2900	9.07	5.2	4.60	5.60	A++	A+++	4.35
16	13	05	4.09	3.12	1.49	2.0	8.7	11.5	360	2000	2900	9.07	5.2	4.60	5.60	A++	A+++	4.35
18	13	05	4.28	3.00	1.43	2.0	8.7	11.5	360	2000	2900	9.07	5.2	4.60	5.60	A++	A+++	4.35
22	13	05	4.61	2.77	1.32	2.0	8.7	11.5	360	2000	2900	9.07	5.2	4.60	5.60	A++	A+++	4.35
24	13	05	4.90	2.57	1.23	2.0	8.7	11.5	360	2000	2900	9.07	5.2	4.60	5.60	A++	A+++	4.35
16	16	05	3.68	3.68	1.34	2.0	8.7	11.5	360	2000	2900	9.07	5.2	4.60	5.60	A++	A+++	4.35
18	16	05	3.87	3.54	1.29	2.0	8.7	11.5	360	2000	2900	9.07	5.2	4.60	5.60	A++	A+++	4.35
22	16	05	4.20	3.30	1.20	2.0	8.7	11.5	360	2000	2900	9.07	5.2	4.60	5.60	A++	A+++	4.35
24	16	05	4.49	3.09	1.12	2.0	8.7	11.5	360	2000	2900	9.07	5.2	4.60	5.60	A++	A+++	4.35
07	07	07	2.50	2.50	2.50	1.9	7.5	10.8	350	1750	2740	7.97	4.5	4.50	5.50	A+	A+++	4.29
10	07	07	3.20	2.50	2.50	2.0	8.2	11.5	360	1900	2900	8.63	4.9	4.50	5.50	A+	A+++	4.32
13	07	07	3.97	2.36	2.36	2.0	8.7	11.5	360	2000	2900	9.07	5.2	4.60	5.60	A++	A+++	4.35
16	07	07	4.56	2.07	2.07	2.0	8.7	11.5	360	2000	2900	9.07	5.2	4.60	5.60	A++	A+++	4.35
18	07	07	4.75	1.98	1.98	2.0	8.7	11.5	360	2000	2900	9.07	5.2	4.60	5.60	A++	A+++	4.35
22	07	07	5.08	1.81	1.81	2.0	8.7	11.5	360	2000	2900	9.07	5.2	4.60	5.60	A++	A+++	4.35
24	07	07	5.35	1.67	1.67	2.0	8.7	11.5	360	2000	2900	9.07	5.2	4.60	5.60	A++	A+++	4.

**RAS-3M26G3AVG-E / TR - Performances in Heating mode**

Operating Status	Combination			Unit capacity (kW)			Heating capacity (kW)			Power input (W)			Operating current (A)		Lot.10 SCOP Warm climate	Average climate	Label Warm climate	COP Nom.		
	Unit A	Unit B	Unit C	Unit A	Unit B	Unit C	Min.	Nom.	Max.	Min.	Nom.	Max.	Nom.	PdH						
Heating, 230 V	3 units operations	13	13	10	3.15	3.15	2.40	2.0	8.7	11.5	360	2000	2900	9.07	5.2	4.60	5.60	A++	A+++	4.35
		16	13	10	3.71	2.83	2.16	2.0	8.7	11.5	360	2000	2900	9.07	5.2	4.60	5.60	A++	A+++	4.35
		18	13	10	3.90	2.73	2.08	2.0	8.7	11.5	360	2000	2900	9.07	5.2	4.60	5.60	A++	A+++	4.35
		22	13	10	4.23	2.54	1.93	2.0	8.7	11.5	360	2000	2900	9.07	5.2	4.60	5.60	A++	A+++	4.35
		24	13	10	4.52	2.37	1.81	2.0	8.7	11.5	360	2000	2900	9.07	5.2	4.60	5.60	A++	A+++	4.35
		16	16	10	3.37	3.37	1.96	2.0	8.7	11.5	360	2000	2900	9.07	5.2	4.60	5.60	A++	A+++	4.35
		18	16	10	3.55	3.26	1.89	2.0	8.7	11.5	360	2000	2900	9.07	5.2	4.60	5.60	A++	A+++	4.35
		22	16	10	3.88	3.05	1.77	2.0	8.7	11.5	360	2000	2900	9.07	5.2	4.60	5.60	A++	A+++	4.35
		24	16	10	4.17	2.87	1.67	2.0	8.7	11.5	360	2000	2900	9.07	5.2	4.60	5.60	A++	A+++	4.35
		13	13	13	2.90	2.90	2.90	2.0	8.7	11.5	360	2000	2900	9.07	5.2	4.60	5.60	A++	A+++	4.35
		16	13	13	3.44	2.63	2.63	2.0	8.7	11.5	360	2000	2900	9.07	5.2	4.60	5.60	A++	A+++	4.35
		18	13	13	3.63	2.54	2.54	2.0	8.7	11.5	360	2000	2900	9.07	5.2	4.60	5.60	A++	A+++	4.35
		22	13	13	3.95	2.37	2.37	2.0	8.7	11.5	360	2000	2900	9.07	5.2	4.60	5.60	A++	A+++	4.35
		24	13	13	4.24	2.23	2.23	2.0	8.7	11.5	360	2000	2900	9.07	5.2	4.60	5.60	A++	A+++	4.35
		16	16	13	3.15	3.15	2.40	2.0	8.7	11.5	360	2000	2900	9.07	5.2	4.60	5.60	A++	A+++	4.35
		18	16	13	3.32	3.05	2.33	2.0	8.7	11.5	360	2000	2900	9.07	5.2	4.60	5.60	A++	A+++	4.35
		22	16	13	3.65	2.87	2.19	2.0	8.7	11.5	360	2000	2900	9.07	5.2	4.60	5.60	A++	A+++	4.35
		24	16	13	3.93	2.70	2.06	2.0	8.7	11.5	360	2000	2900	9.07	5.2	4.60	5.60	A++	A+++	4.35
		16	16	16	2.90	2.90	2.90	2.0	8.7	11.5	360	2000	2900	9.07	5.2	4.60	5.60	A++	A+++	4.35
		18	16	16	3.07	2.81	2.81	2.0	8.7	11.5	360	2000	2900	9.07	5.2	4.60	5.60	A++	A+++	4.35
		22	16	16	3.38	2.66	2.66	2.0	8.7	11.5	360	2000	2900	9.07	5.2	4.60	5.60	A++	A+++	4.35

**RAS-4M27G3AVG-E / TR - Performances in Cooling mode**

Operating Status	Combination				Unit capacity (kW)				Cooling capacity (kW)			Power input (W)			Operating current (A)		Lot.10 SEER	Class	EER Nom.	
	Unit A	Unit B	Unit C	Unit D	Unit A	Unit B	Unit C	Unit D	Min.	Nom.	Max.	Min.	Nom.	Max.	Nom.	PdC				
Cooling, 230 V	1 unit operation	05	-	-	-	1.50	-	-	-	1.4	1.5	2.0	350	350	360	-	-	-	-	-
		07	-	-	-	2.00	-	-	-	1.5	2.0	2.9	350	470	650	-	-	-	-	-
		10	-	-	-	2.50	-	-	-	1.5	2.5	3.2	350	590	750	-	-	-	-	-
		13	-	-	-	3.50	-	-	-	1.6	3.5	4.1	350	830	1030	-	-	-	-	-
		16	-	-	-	4.60	-	-	-	1.7	4.6	5.3	350	1090	1410	-	-	-	-	-
		18	-	-	-	5.00	-	-	-	1.7	5.0	6.0	350	1190	1630	-	-	-	-	-
		22	-	-	-	6.10	-	-	-	1.8	6.1	6.7	350	1450	1860	-	-	-	-	-
		24	-	-	-	7.00	-	-	-	1.9	7.0	7.7	350	1670	2170	-	-	-	-	-
		05	05	-	-	1.50	1.50	-	-	1.5	3.0	4.0	350	710	1000	3.42	3.0	6.80	A++	4.23
		07	05	-	-	2.00	1.50	-	-	1.6	3.5	4.9	350	830	1290	3.87	3.5	7.00	A++	4.22
		10	05	-	-	2.50	1.50	-	-	1.6	4.0	5.2	350	950	1380	4.41	4.0	7.20	A++	4.21
		13	05	-	-	3.50	1.50	-	-	1.7	5.0	6.1	350	1190	1670	5.48	5.0	7.50	A++	4.20
		16	05	-	-	4.60	1.50	-	-	1.8	6.1	7.3	350	1450	2050	6.64	6.1	7.90	A++	4.21
		18	05	-	-	5.00	1.50	-	-	1.9	6.5	8.0	350	1550	2270	7.08	6.5	8.00	A++	4.19
		22	05	-	-	6.10	1.50	-	-	2.0	7.6	8.7	350	1810	2490	8.23	7.6	8.40	A++	4.20
		24	05	-	-	6.59	1.41	-	-	2.0	8.0	9.7	350	1900	2810	8.63	8.0	8.50	A+++	4.21
		07	07	-	-	2.00	2.00	-	-	1.6	4.0	5.8	350	950	1570	4.41	4.0	7.20	A++	4.21
		10	07	-	-	2.50	2.00	-	-	1.7	4.5	6.1	350	1070	1670	4.95	4.5	7.40	A++	4.21
		13	07	-	-	3.50	2.00	-	-	1.8	5.5	7.0	350	1310	1950	6.02	5.5	7.70	A++	4.20
		16	07	-	-	4.60	2.00	-	-	1.9	6.6	8.2	350	1570	2330	7.17	6.6	8.10	A++	4.20
		18	07	-	-	5.00	2.00	-	-	1.9	7.0	8.9	350	1670	2560	7.61	7.0	8.20	A++	4.19
		22	07	-	-	6.02	1.98	-	-	2.0	8.0	9.6	350	1900	2780	8.63	8.0	8.50	A+++	4.21
24	07	-	-	6.22	1.78	-	-	2.0	8.0	10.0	350	1900	2900	8.63	8.0	8.50	A+++	4.21		
10	10	-	-	2.50	2.50	-	-	1.7	5.0	6.4	350	1190	1760	5.48	5.0	7.50	A++	4.20		
13	10	-	-	3.50	2.50	-	-	1.8	6.0	7.3	350	1430	2050	6.55	6.0	7.90	A++	4.20		
16	10	-	-	4.60	2.50	-	-	1.9	7.1	8.5	350	1690	2430	7.70	7.1	8.30	A++	4.20		
18	10	-	-	5.00	2.50	-	-	2.0	7.5	9.2	350	1790	2650	8.14	7.5	8.40	A++	4.19		
22	10	-	-	5.67	2.33	-	-	2.0	8.0	9.9	350	1900	2870	8.63	8.0	8.50	A+++	4.21		
24	10	-	-	5.89	2.11	-	-	2.0	8.0	10.0	350	1900	2900	8.63	8.0	8.50	A+++	4.21		
13	13	-	-	3.50	3.50	-	-	1.9	7.0	8.2	350	1670	2330	7.61	7.0	8.20	A++	4.19		
16	13	-	-	4.54	3.46	-	-	2.0	8.0	9.4	350	1900	2710	8.63	8.0	8.50	A+++	4.21		
18	13	-	-	4.71	3.29	-	-	2.0	8.0	10.0	350	1900	2900	8.63	8.0	8.50	A+++	4.21		
22	13	-	-	5.08	2.92	-	-	2.0	8.0	10.0	350	1900	2900	8.63	8.0	8.50	A+++	4.21		
24	13	-	-	5.33	2.67	-	-	2.0	8.0	10.0	350	1900	2900	8.63	8.0	8.50	A+++	4.21		
16	16	-	-	4.00	4.00	-	-	2.0	8.0	10.0	350	1900	2900	8.63	8.0	8.50	A+++	4.21		
18	16	-	-	4.17	3.83	-	-	2.0	8.0	10.0	350	1900	2900	8.63	8.0	8.50	A+++	4.21		
22	16	-	-	4.56	3.44	-	-	2.0	8.0	10.0	350	1900	2900	8.63	8.0	8.50	A+++	4.21		
24	16	-	-	4.83	3.17	-	-	2.0	8.0	10.0	350	1900	2900	8.63	8.0	8.50	A+++	4.21		
18	18	-	-	4.00	4.00	-	-	2.0	8.0	10.0	350	1900	2900	8.63	8.0	8.50	A+++	4.21		
22	18	-	-	4.40	3.60	-	-	2.0	8.0	10.0	350	1900	2900	8.63	8.0	8.50	A+++	4.21		
24	18	-	-	4.67	3.33	-	-	2.0	8.0	10.0	350	1900	2900	8.63	8.0	8.50	A+++	4.21		
05	05	05	-	1.50	1.50	1.50	-	1.7	4.5	6.0	350	1070	1630	4.95	4.5	7.20	A++	4.21		
07	05	05	-	2.00	1.50	1.50	-	1.7	5.0	6.9	350	1190	1920	5.48	5.0	7.40	A++	4.20		
10	05	05	-	2.50	1.50	1.50	-	1.8	5.5	7.2	350	1310	2020	6.02	5.5	7.50	A++	4.20		
13	05	05	-	3.50	1.50	1.50	-	1.9	6.5	8.1	350	1550	2300	7.08	6.5	7.90	A++	4.19		
16	05	05	-	4.60	1.50	1.50	-	2.0	7.6	9.3	350	1810	2680	8.23	7.6	8.30	A++	4.20		
18	05	05	-	5.00	1.50	1.50	-	2.0	8.0	10.0	350	1900	2900	8.63	8.0	8.40	A++	4.21		
22	05	05	-	5.36	1.32	1.32	-	2.0	8.0	10.0	350	1900	2900	8.63	8.0	8.40	A++	4.21		
24	05	05	-	5.60	1.20	1.20	-	2.0	8.0	10.0	350	1900	2900	8.63	8.0	8.40	A++	4.21		
07	07	05	-	2.00	2.00	1.50	-	1.8	5.5	7.8	350	1310	2210	6.02	5.5	7.60	A++	4.20		
10	07	05	-	2.50	2.00	1.50	-	1.8	6.0	8.1	350	1430	2300	6.55	6.0	7.70	A++	4.20		
13	07	05	-	3.50	2.00	1.50	-	1.9	7.0	9.0	350	1670	2590	7.61	7.0	8.10	A++	4.19		
16	07	05	-	4.54	1.98	1.48	-	2.0	8.0	10.0	350	1900	2900	8.63	8.0	8.40	A++	4.21		
18	07	05	-	4.71	1.88	1.41	-	2.0	8.0	10.0	350	1900	2900	8.63	8.0	8.40	A++	4.21		
22	07	05	-	5.08	1.67	1.25	-	2.0	8.0	10.0	350	1900	2900	8.63	8.0	8.40	A++	4.21		
24	07	05	-	5.33	1.52	1.14	-	2.0	8.0	10.0	350	1900	2900	8.63	8.0	8.40	A++	4.21		



**RAS-4M27G3AVG-E / TR - Performances in Cooling mode**

Operating Status	Combination				Unit capacity (kW)				Cooling capacity (kW)			Power input (W)			Operating current (A)		Loi.10 SEER	Class	EER Nom.
	Unit A	Unit B	Unit C	Unit D	Unit A	Unit B	Unit C	Unit D	Min.	Nom.	Max.	Min.	Nom.	Max.	Nom.	Pdc			
3 units operations	18	18	05	-	3.48	3.48	1.04	-	2.0	8.0	10.0	350	1900	2900	8.63	8.0	8.40	+++	4.21
	22	18	05	-	3.87	3.17	0.95	-	2.0	8.0	10.0	350	1900	2900	8.63	8.0	8.40	+++	4.21
	24	18	05	-	4.15	2.96	0.89	-	2.0	8.0	10.0	350	1900	2900	8.63	8.0	8.40	+++	4.21
	07	07	07	-	2.00	2.00	2.00	-	1.8	6.0	8.7	350	1430	2490	6.55	6.0	7.70	+++	4.20
	10	07	07	-	2.50	2.00	2.00	-	1.9	6.5	9.0	350	1550	2590	7.08	6.5	7.90	+++	4.19
	13	07	07	-	3.50	2.00	2.00	-	2.0	7.5	9.9	350	1790	2870	8.14	7.5	8.30	+++	4.19
	16	07	07	-	4.28	1.86	1.86	-	2.0	8.0	10.0	350	1900	2900	8.63	8.0	8.40	+++	4.21
	18	07	07	-	4.44	1.78	1.78	-	2.0	8.0	10.0	350	1900	2900	8.63	8.0	8.40	+++	4.21
	22	07	07	-	4.83	1.58	1.58	-	2.0	8.0	10.0	350	1900	2900	8.63	8.0	8.40	+++	4.21
	24	07	07	-	5.09	1.45	1.45	-	2.0	8.0	10.0	350	1900	2900	8.63	8.0	8.40	+++	4.21
	10	10	07	-	2.50	2.50	2.00	-	1.9	7.0	9.3	350	1670	2680	7.61	7.0	8.10	+++	4.19
	13	10	07	-	3.50	2.50	2.00	-	2.0	8.0	10.0	350	1900	2900	8.63	8.0	8.40	+++	4.21
	16	10	07	-	4.04	2.20	1.76	-	2.0	8.0	10.0	350	1900	2900	8.63	8.0	8.40	+++	4.21
	18	10	07	-	4.21	2.11	1.68	-	2.0	8.0	10.0	350	1900	2900	8.63	8.0	8.40	+++	4.21
	22	10	07	-	4.60	1.89	1.51	-	2.0	8.0	10.0	350	1900	2900	8.63	8.0	8.40	+++	4.21
	24	10	07	-	4.87	1.74	1.39	-	2.0	8.0	10.0	350	1900	2900	8.63	8.0	8.40	+++	4.21
	13	13	07	-	3.11	3.11	1.78	-	2.0	8.0	10.0	350	1900	2900	8.63	8.0	8.40	+++	4.21
	16	13	07	-	3.64	2.77	1.58	-	2.0	8.0	10.0	350	1900	2900	8.63	8.0	8.40	+++	4.21
	18	13	07	-	3.81	2.67	1.52	-	2.0	8.0	10.0	350	1900	2900	8.63	8.0	8.40	+++	4.21
	22	13	07	-	4.21	2.41	1.38	-	2.0	8.0	10.0	350	1900	2900	8.63	8.0	8.40	+++	4.21
	24	13	07	-	4.48	2.24	1.28	-	2.0	8.0	10.0	350	1900	2900	8.63	8.0	8.40	+++	4.21
	16	16	07	-	3.29	3.29	1.43	-	2.0	8.0	10.0	350	1900	2900	8.63	8.0	8.40	+++	4.21
	18	16	07	-	3.45	3.17	1.38	-	2.0	8.0	10.0	350	1900	2900	8.63	8.0	8.40	+++	4.21
	22	16	07	-	3.84	2.90	1.26	-	2.0	8.0	10.0	350	1900	2900	8.63	8.0	8.40	+++	4.21
	24	16	07	-	4.12	2.71	1.18	-	2.0	8.0	10.0	350	1900	2900	8.63	8.0	8.40	+++	4.21
	18	18	07	-	3.33	3.33	1.33	-	2.0	8.0	10.0	350	1900	2900	8.63	8.0	8.40	+++	4.21
	22	18	07	-	3.73	3.05	1.22	-	2.0	8.0	10.0	350	1900	2900	8.63	8.0	8.40	+++	4.21
	24	18	07	-	4.00	2.86	1.14	-	2.0	8.0	10.0	350	1900	2900	8.63	8.0	8.40	+++	4.21
	10	10	10	-	2.50	2.50	2.50	-	2.0	7.5	9.6	350	1790	2780	8.14	7.5	8.30	+++	4.19
	13	10	10	-	3.29	2.35	2.35	-	2.0	8.0	10.0	350	1900	2900	8.63	8.0	8.40	+++	4.21
	16	10	10	-	3.83	2.08	2.08	-	2.0	8.0	10.0	350	1900	2900	8.63	8.0	8.40	+++	4.21
	18	10	10	-	4.00	2.00	2.00	-	2.0	8.0	10.0	350	1900	2900	8.63	8.0	8.40	+++	4.21
	22	10	10	-	4.40	1.80	1.80	-	2.0	8.0	10.0	350	1900	2900	8.63	8.0	8.40	+++	4.21
	24	10	10	-	4.67	1.67	1.67	-	2.0	8.0	10.0	350	1900	2900	8.63	8.0	8.40	+++	4.21
	13	13	10	-	2.95	2.95	2.11	-	2.0	8.0	10.0	350	1900	2900	8.63	8.0	8.40	+++	4.21
	16	13	10	-	3.47	2.64	1.89	-	2.0	8.0	10.0	350	1900	2900	8.63	8.0	8.40	+++	4.21
	18	13	10	-	3.64	2.55	1.82	-	2.0	8.0	10.0	350	1900	2900	8.63	8.0	8.40	+++	4.21
	22	13	10	-	4.03	2.31	1.65	-	2.0	8.0	10.0	350	1900	2900	8.63	8.0	8.40	+++	4.21
	24	13	10	-	4.31	2.15	1.54	-	2.0	8.0	10.0	350	1900	2900	8.63	8.0	8.40	+++	4.21
	16	16	10	-	3.15	3.15	1.71	-	2.0	8.0	10.0	350	1900	2900	8.63	8.0	8.40	+++	4.21
	18	16	10	-	3.31	3.04	1.65	-	2.0	8.0	10.0	350	1900	2900	8.63	8.0	8.40	+++	4.21
	22	16	10	-	3.70	2.79	1.52	-	2.0	8.0	10.0	350	1900	2900	8.63	8.0	8.40	+++	4.21
	24	16	10	-	3.97	2.61	1.42	-	2.0	8.0	10.0	350	1900	2900	8.63	8.0	8.40	+++	4.21
	18	18	10	-	3.20	3.20	1.60	-	2.0	8.0	10.0	350	1900	2900	8.63	8.0	8.40	+++	4.21
	22	18	10	-	3.59	2.94	1.47	-	2.0	8.0	10.0	350	1900	2900	8.63	8.0	8.40	+++	4.21
	24	18	10	-	3.86	2.76	1.38	-	2.0	8.0	10.0	350	1900	2900	8.63	8.0	8.40	+++	4.21
	13	13	13	-	2.67	2.67	2.67	-	2.0	8.0	10.0	350	1900	2900	8.63	8.0	8.40	+++	4.21
	16	13	13	-	3.17	2.41	2.41	-	2.0	8.0	10.0	350	1900	2900	8.63	8.0	8.40	+++	4.21
18	13	13	-	3.33	2.33	2.33	-	2.0	8.0	10.0	350	1900	2900	8.63	8.0	8.40	+++	4.21	
22	13	13	-	3.73	2.14	2.14	-	2.0	8.0	10.0	350	1900	2900	8.63	8.0	8.40	+++	4.21	
24	13	13	-	4.00	2.00	2.00	-	2.0	8.0	10.0	350	1900	2900	8.63	8.0	8.40	+++	4.21	
16	16	13	-	2.90	2.90	2.20	-	2.0	8.0	10.0	350	1900	2900	8.63	8.0	8.40	+++	4.21	
18	16	13	-	3.05	2.81	2.14	-	2.0	8.0	10.0	350	1900	2900	8.63	8.0	8.40	+++	4.21	
22	16	13	-	3.44	2.59	1.97	-	2.0	8.0	10.0	350	1900	2900	8.63	8.0	8.40	+++	4.21	
24	16	13	-	3.71	2.44	1.85	-	2.0	8.0	10.0	350	1900	2900	8.63	8.0	8.40	+++	4.21	
18	18	13	-	2.96	2.96	2.07	-	2.0	8.0	10.0	350	1900	2900	8.63	8.0	8.40	+++	4.21	
22	18	13	-	3.34	2.74	1.92	-	2.0	8.0	10.0	350	1900	2900	8.63	8.0	8.40	+++	4.21	
16	16	16	-	2.67	2.67	2.67	-	2.0	8.0	10.0	350	1900	2900	8.63	8.0	8.40	+++	4.21	
18	16	16	-	2.82	2.59	2.59	-	2.0	8.0	10.0	350	1900	2900	8.63	8.0	8.40	+++	4.21	
22	16	16	-	3.19	2.41	2.41	-	2.0	8.0	10.0	350	1900	2900	8.63	8.0	8.40	+++	4.21	
05	05	05	05	1.50	1.50	1.50	1.50	1.8	6.0	8.0	350	1430	2270	6.55	6.0	7.60	+++	4.20	
07	05	05	05	2.00	1.50	1.50	1.50	1.9	6.5	8.9	350	1550	2560	7.08	6.5	7.80	+++	4.19	
10	05	05	05	2.50	1.50	1.50	1.50	1.9	7.0	9.2	350	1670	2650	7.61	7.0	8.00	+++	4.19	
13	05	05	05	3.50	1.50	1.50	1.50	2.0	8.0	10.0	350	1900	2900	8.63	8.0	8.30	+++	4.21	
16	05	05	05	4.04	1.32	1.32	1.32	2.0	8.0	10.0	350	1900	2900	8.63	8.0	8.30	+++	4.21	
18	05	05	05	4.21	1.26	1.26	1.26	2.0	8.0	10.0	350	1900	2900	8.63	8.0	8.30	+++	4.21	
22	05	05	05	4.60	1.13	1.13	1.13	2.0	8.0	10.0	350	1900	2900	8.63	8.0	8.30	+++	4.21	
24	05	05	05	4.87	1.04	1.04	1.04	2.0	8.0	10.0	350	1900	2900	8.63	8.0	8.30	+++	4.21	
07	07	05	05	2.00	2.00	1.50	1.50	1.9	7.0	9.8	350	1670	2840	7.61	7.0	8.00	+++	4.19	
10	07	05	05	2.50	2.00	1.50	1.50	2.0	7.5	10.0	350	1790	2900	8.14	7.5	8.10	+++	4.19	
13	07	05	05	3.29	1.88	1.41	1.41	2.0	8.0	10.0	350	1900	2900	8.63	8.0	8.30	+++	4.21	
16	07	05	05	3.83	1.67	1.25	1.25	2.0	8.0	10.0	350	1900	2900	8.63	8.0	8.30	+++	4.21	
18	07	05	05	4.00	1.60	1.20	1.20	2.0	8.0	10.0	350	1900	2900	8.63	8.0	8.30	+++	4.21	
22	07	05	05	4.40	1.44	1.08	1.08	2.0	8.0	10.0	350	1900	2900	8.63	8.0	8.30	+++	4.21	
24	07	05	05	4.67	1.33	1.00	1.00	2.0	8.0	10.0	350	1900	2900	8.63	8.0	8.30	+++	4.21	
10	10	05	05	2.50	2.50	1.50	1.50	2.0	8.0	10.0	350	1900	2900	8.63	8.0	8.30	+++	4.21	
13	10	05	05	3.11	2.22	1.3													



RAS-4M27G3AVG-E / TR - Performances in Cooling mode

Operating Status	Combination				Unit capacity (kW)				Cooling capacity (kW)			Power input (W)			Operating current (A)		Lot.10 SEER	Class	EER Nom.
	Unit A	Unit B	Unit C	Unit D	Unit A	Unit B	Unit C	Unit D	Min.	Nom.	Max.	Min.	Nom.	Max.	Nom.	Pdc			
18	10	07	05	05	3.64	1.82	1.45	1.09	2.0	8.0	10.0	350	1900	2900	8.63	8.0	8.30	A++	4.21
22	10	07	05	05	4.03	1.65	1.32	0.99	2.0	8.0	10.0	350	1900	2900	8.63	8.0	8.30	A++	4.21
24	10	07	05	05	4.31	1.54	1.23	0.92	2.0	8.0	10.0	350	1900	2900	8.63	8.0	8.30	A++	4.21
13	13	07	05	05	2.67	2.67	1.52	1.14	2.0	8.0	10.0	350	1900	2900	8.63	8.0	8.30	A++	4.21
16	13	07	05	05	3.17	2.41	1.38	1.03	2.0	8.0	10.0	350	1900	2900	8.63	8.0	8.30	A++	4.21
18	13	07	05	05	3.33	2.33	1.33	1.00	2.0	8.0	10.0	350	1900	2900	8.63	8.0	8.30	A++	4.21
22	13	07	05	05	3.73	2.14	1.22	0.92	2.0	8.0	10.0	350	1900	2900	8.63	8.0	8.30	A++	4.21
24	13	07	05	05	4.00	2.00	1.14	0.86	2.0	8.0	10.0	350	1900	2900	8.63	8.0	8.30	A++	4.21
16	16	07	05	05	2.90	2.90	1.26	0.94	2.0	8.0	10.0	350	1900	2900	8.63	8.0	8.30	A++	4.21
18	16	07	05	05	3.05	2.81	1.22	0.92	2.0	8.0	10.0	350	1900	2900	8.63	8.0	8.30	A++	4.21
18	18	07	05	05	2.96	2.96	1.19	0.89	2.0	8.0	10.0	350	1900	2900	8.63	8.0	8.30	A++	4.21
10	10	10	05	05	2.22	2.22	2.22	1.33	2.0	8.0	10.0	350	1900	2900	8.63	8.0	8.30	A++	4.21
13	10	10	05	05	2.80	2.00	2.00	1.20	2.0	8.0	10.0	350	1900	2900	8.63	8.0	8.30	A++	4.21
16	10	10	05	05	3.32	1.80	1.80	1.08	2.0	8.0	10.0	350	1900	2900	8.63	8.0	8.30	A++	4.21
18	10	10	05	05	3.48	1.74	1.74	1.04	2.0	8.0	10.0	350	1900	2900	8.63	8.0	8.30	A++	4.21
22	10	10	05	05	3.87	1.59	1.59	0.95	2.0	8.0	10.0	350	1900	2900	8.63	8.0	8.30	A++	4.21
24	10	10	05	05	4.15	1.48	1.48	0.89	2.0	8.0	10.0	350	1900	2900	8.63	8.0	8.30	A++	4.21
13	13	10	05	05	2.55	2.55	1.82	1.09	2.0	8.0	10.0	350	1900	2900	8.63	8.0	8.30	A++	4.21
16	13	10	05	05	3.04	2.31	1.65	0.99	2.0	8.0	10.0	350	1900	2900	8.63	8.0	8.30	A++	4.21
18	13	10	05	05	3.20	2.24	1.60	0.96	2.0	8.0	10.0	350	1900	2900	8.63	8.0	8.30	A++	4.21
22	13	10	05	05	3.59	2.06	1.47	0.88	2.0	8.0	10.0	350	1900	2900	8.63	8.0	8.30	A++	4.21
24	13	10	05	05	3.86	1.93	1.38	0.83	2.0	8.0	10.0	350	1900	2900	8.63	8.0	8.30	A++	4.21
16	16	10	05	05	2.79	2.79	1.52	0.91	2.0	8.0	10.0	350	1900	2900	8.63	8.0	8.30	A++	4.21
18	16	10	05	05	2.94	2.71	1.47	0.88	2.0	8.0	10.0	350	1900	2900	8.63	8.0	8.30	A++	4.21
18	18	10	05	05	2.86	2.86	1.43	0.86	2.0	8.0	10.0	350	1900	2900	8.63	8.0	8.30	A++	4.21
13	13	13	05	05	2.33	2.33	2.33	1.00	2.0	8.0	10.0	350	1900	2900	8.63	8.0	8.30	A++	4.21
16	13	13	05	05	2.81	2.14	2.14	0.92	2.0	8.0	10.0	350	1900	2900	8.63	8.0	8.30	A++	4.21
18	13	13	05	05	2.96	2.07	2.07	0.89	2.0	8.0	10.0	350	1900	2900	8.63	8.0	8.30	A++	4.21
16	16	13	05	05	2.59	2.59	1.97	0.85	2.0	8.0	10.0	350	1900	2900	8.63	8.0	8.30	A++	4.21
18	16	13	05	05	2.74	2.52	1.92	0.82	2.0	8.0	10.0	350	1900	2900	8.63	8.0	8.30	A++	4.21
07	07	07	07	07	2.00	2.00	2.00	2.00	2.0	8.0	10.0	350	1900	2900	8.63	8.0	8.30	A++	4.21
10	07	07	07	07	2.35	1.88	1.88	1.88	2.0	8.0	10.0	350	1900	2900	8.63	8.0	8.30	A++	4.21
13	07	07	07	07	2.95	1.68	1.68	1.68	2.0	8.0	10.0	350	1900	2900	8.63	8.0	8.30	A++	4.21
16	07	07	07	07	3.47	1.51	1.51	1.51	2.0	8.0	10.0	350	1900	2900	8.63	8.0	8.30	A++	4.21
18	07	07	07	07	3.64	1.45	1.45	1.45	2.0	8.0	10.0	350	1900	2900	8.63	8.0	8.30	A++	4.21
22	07	07	07	07	4.03	1.32	1.32	1.32	2.0	8.0	10.0	350	1900	2900	8.63	8.0	8.30	A++	4.21
24	07	07	07	07	4.31	1.23	1.23	1.23	2.0	8.0	10.0	350	1900	2900	8.63	8.0	8.30	A++	4.21
10	10	07	07	07	2.22	2.22	1.78	1.78	2.0	8.0	10.0	350	1900	2900	8.63	8.0	8.30	A++	4.21
13	10	07	07	07	2.80	2.00	1.60	1.60	2.0	8.0	10.0	350	1900	2900	8.63	8.0	8.30	A++	4.21
16	10	07	07	07	3.32	1.80	1.44	1.44	2.0	8.0	10.0	350	1900	2900	8.63	8.0	8.30	A++	4.21
18	10	07	07	07	3.48	1.74	1.39	1.39	2.0	8.0	10.0	350	1900	2900	8.63	8.0	8.30	A++	4.21
22	10	07	07	07	3.87	1.59	1.27	1.27	2.0	8.0	10.0	350	1900	2900	8.63	8.0	8.30	A++	4.21
24	10	07	07	07	4.15	1.48	1.19	1.19	2.0	8.0	10.0	350	1900	2900	8.63	8.0	8.30	A++	4.21
13	13	07	07	07	2.55	2.55	1.45	1.45	2.0	8.0	10.0	350	1900	2900	8.63	8.0	8.30	A++	4.21
16	13	07	07	07	3.04	2.31	1.32	1.32	2.0	8.0	10.0	350	1900	2900	8.63	8.0	8.30	A++	4.21
18	13	07	07	07	3.20	2.24	1.28	1.28	2.0	8.0	10.0	350	1900	2900	8.63	8.0	8.30	A++	4.21
22	13	07	07	07	3.59	2.06	1.18	1.18	2.0	8.0	10.0	350	1900	2900	8.63	8.0	8.30	A++	4.21
24	13	07	07	07	3.86	1.93	1.10	1.10	2.0	8.0	10.0	350	1900	2900	8.63	8.0	8.30	A++	4.21
16	16	07	07	07	2.79	2.79	1.21	1.21	2.0	8.0	10.0	350	1900	2900	8.63	8.0	8.30	A++	4.21
18	16	07	07	07	2.94	2.71	1.18	1.18	2.0	8.0	10.0	350	1900	2900	8.63	8.0	8.30	A++	4.21
18	18	07	07	07	2.86	2.86	1.14	1.14	2.0	8.0	10.0	350	1900	2900	8.63	8.0	8.30	A++	4.21
10	10	10	07	07	2.11	2.11	2.11	1.68	2.0	8.0	10.0	350	1900	2900	8.63	8.0	8.30	A++	4.21
13	10	10	07	07	2.67	1.90	1.90	1.52	2.0	8.0	10.0	350	1900	2900	8.63	8.0	8.30	A++	4.21
16	10	10	07	07	3.17	1.72	1.72	1.38	2.0	8.0	10.0	350	1900	2900	8.63	8.0	8.30	A++	4.21
18	10	10	07	07	3.33	1.67	1.67	1.33	2.0	8.0	10.0	350	1900	2900	8.63	8.0	8.30	A++	4.21
22	10	10	07	07	3.73	1.53	1.53	1.22	2.0	8.0	10.0	350	1900	2900	8.63	8.0	8.30	A++	4.21
24	10	10	07	07	4.00	1.43	1.43	1.14	2.0	8.0	10.0	350	1900	2900	8.63	8.0	8.30	A++	4.21
13	13	10	07	07	2.43	2.43	1.74	1.39	2.0	8.0	10.0	350	1900	2900	8.63	8.0	8.30	A++	4.21
16	13	10	07	07	2.92	2.22	1.59	1.27	2.0	8.0	10.0	350	1900	2900	8.63	8.0	8.30	A++	4.21
18	13	10	07	07	3.08	2.15	1.54	1.23	2.0	8.0	10.0	350	1900	2900	8.63	8.0	8.30	A++	4.21
22	13	10	07	07	3.46	1.99	1.42	1.13	2.0	8.0	10.0	350	1900	2900	8.63	8.0	8.30	A++	4.21
24	13	10	07	07	3.73	1.87	1.33	1.07	2.0	8.0	10.0	350	1900	2900	8.63	8.0	8.30	A++	4.21
16	16	10	07	07	2.69	2.69	1.46	1.17	2.0	8.0	10.0	350	1900	2900	8.63	8.0	8.30	A++	4.21
18	16	10	07	07	2.84	2.61	1.42	1.13	2.0	8.0	10.0	350	1900	2900	8.63	8.0	8.30	A++	4.21
18	18	10	07	07	2.76	2.76	1.38	1.10	2.0	8.0	10.0	350	1900	2900	8.63	8.0	8.30	A++	4.21
13	13	13	07	07	2.24	2.24	2.24	1.28	2.0	8.0	10.0	350	1900	2900	8.63	8.0	8.30	A++	4.21
16	13	13	07	07	2.71	2.06	2.06	1.18	2.0	8.0	10.0	350	1900	2900	8.63	8.0	8.30	A++	4.21
18	13	13	07	07	2.86	2.00	2.00	1.14	2.0	8.0	10.0	350	1900	2900	8.63	8.0	8.30	A++	4.21
16	16	13	07	07	2.50	2.50	1.90	1.09	2.0	8.0	10.0	350	1900	2900	8.63	8.0	8.30	A++	4.21
18	16	13	07	07	2.65	2.44	1.85	1.06	2.0	8.0	10.0	350	1900	2900	8.63	8.0	8.30	A++	4.21
10	10	10	10	10	2.00	2.00	2.00	2.00	2.0	8.0	10.0	350	1900	2900	8.63	8.0	8.30	A++	4.21
13	10	10	10	10	2.55	1.82	1.82	1.82											



**RAS-4M27G3AVG-E / TR - Performances in Heating mode**

Operating Status	Combination				Unit capacity (kW)				Heating capacity (kW)			Power input (W)			Operating current (A)		Lot.10		Label	COP		
	Unit A	Unit B	Unit C	Unit D	Unit A	Unit B	Unit C	Unit D	Min.	Nom.	Max.	Min.	Nom.	Max.	Nom.	Psh	SCOP	SCOP Warm climate			Average climate	Warm climate
1 unit operation	05	-	-	-	2.00	-	-	-	1.3	2.0	2.5	300	550	750	-	-	-	-	-	-	-	
	07	-	-	-	2.50	-	-	-	1.4	2.5	3.6	310	650	990	-	-	-	-	-	-	-	
	10	-	-	-	3.20	-	-	-	1.4	3.2	4.8	320	790	1250	-	-	-	-	-	-	-	
	13	-	-	-	4.20	-	-	-	1.5	4.2	5.3	330	980	1360	-	-	-	-	-	-	-	
	16	-	-	-	5.50	-	-	-	1.7	5.5	6.5	350	1230	1620	-	-	-	-	-	-	-	
	18	-	-	-	6.00	-	-	-	1.7	6.0	6.5	360	1330	1620	-	-	-	-	-	-	-	
	22	-	-	-	7.00	-	-	-	1.8	7.0	7.5	370	1520	1830	-	-	-	-	-	-	-	
	24	-	-	-	8.00	-	-	-	1.9	8.0	8.8	380	1710	2110	-	-	-	-	-	-	-	
	2 units operations	05	05	-	-	2.00	2.00	-	-	1.5	4.0	5.0	330	940	1290	4.36	2.3	4.10	5.90	A+	A+++	4.26
		07	05	-	-	2.50	2.00	-	-	1.6	4.5	6.1	340	1040	1530	4.81	2.6	4.20	6.00	A+	A+++	4.33
10		05	-	-	3.20	2.00	-	-	1.6	5.2	7.3	350	1170	1790	5.39	3.0	4.30	6.00	A+	A+++	4.44	
13		05	-	-	4.20	2.00	-	-	1.7	6.2	7.8	360	1360	1900	6.24	3.6	4.30	5.90	A+	A+++	4.56	
16		05	-	-	5.50	2.00	-	-	1.9	7.5	9.0	380	1620	2160	7.39	4.3	4.30	5.50	A+	A+++	4.63	
18		05	-	-	6.00	2.00	-	-	1.9	8.0	9.0	380	1710	2160	7.79	4.6	4.30	5.50	A+	A+++	4.68	
22		05	-	-	7.00	2.00	-	-	2.0	9.0	10.0	390	1900	2370	8.63	5.2	4.50	5.70	A+	A+++	4.74	
24		05	-	-	7.20	1.80	-	-	2.0	9.0	11.3	390	1900	2650	8.63	5.2	4.50	5.70	A+	A+++	4.74	
07		07	-	-	2.50	2.50	-	-	1.6	5.0	7.2	340	1130	1770	5.22	2.9	4.30	6.00	A+	A+++	4.42	
10		07	-	-	3.20	2.50	-	-	1.7	5.7	8.4	350	1270	2030	5.84	3.3	4.30	6.00	A+	A+++	4.49	
13		07	-	-	4.20	2.50	-	-	1.8	6.7	8.9	370	1460	2140	6.68	3.9	4.30	5.90	A+	A+++	4.59	
16		07	-	-	5.50	2.50	-	-	1.9	8.0	10.1	380	1710	2390	7.79	4.6	4.30	5.60	A+	A+++	4.68	
18		07	-	-	6.00	2.50	-	-	2.0	8.5	10.1	390	1810	2390	8.23	4.9	4.40	5.60	A+	A+++	4.70	
22		07	-	-	6.63	2.37	-	-	2.0	9.0	11.1	390	1900	2610	8.63	5.2	4.50	5.70	A+	A+++	4.74	
24		07	-	-	6.86	2.14	-	-	2.0	9.0	12.0	390	1900	2800	8.63	5.2	4.50	5.70	A+	A+++	4.74	
10		10	-	-	3.20	3.20	-	-	1.7	6.4	9.6	360	1400	2290	6.42	3.7	4.30	5.90	A+	A+++	4.57	
13		10	-	-	4.20	3.20	-	-	1.8	7.4	10.1	370	1600	2390	7.30	4.3	4.30	5.60	A+	A+++	4.63	
16		10	-	-	5.50	3.20	-	-	2.0	8.7	11.3	390	1850	2650	8.41	5.0	4.40	5.70	A+	A+++	4.70	
18		10	-	-	5.87	3.13	-	-	2.0	9.0	11.3	390	1900	2650	8.63	5.2	4.50	5.70	A+	A+++	4.74	
22		10	-	-	6.18	2.82	-	-	2.0	9.0	12.0	390	1900	2800	8.63	5.2	4.50	5.70	A+	A+++	4.74	
24		10	-	-	6.43	2.57	-	-	2.0	9.0	12.0	390	1900	2800	8.63	5.2	4.50	5.70	A+	A+++	4.74	
13		13	-	-	4.20	4.20	-	-	1.9	8.4	10.6	390	1790	2500	8.14	4.9	4.40	5.60	A+	A+++	4.69	
16		13	-	-	5.10	3.90	-	-	2.0	9.0	11.8	390	1900	2760	8.63	5.2	4.50	5.70	A+	A+++	4.74	
18		13	-	-	5.29	3.71	-	-	2.0	9.0	11.8	390	1900	2760	8.63	5.2	4.50	5.70	A+	A+++	4.74	
22		13	-	-	5.63	3.38	-	-	2.0	9.0	12.0	390	1900	2800	8.63	5.2	4.50	5.70	A+	A+++	4.74	
24		13	-	-	5.90	3.10	-	-	2.0	9.0	12.0	390	1900	2800	8.63	5.2	4.50	5.70	A+	A+++	4.74	
16		16	-	-	4.50	4.50	-	-	2.0	9.0	12.0	390	1900	2800	8.63	5.2	4.50	5.70	A+	A+++	4.74	
18		16	-	-	4.70	4.30	-	-	2.0	9.0	12.0	390	1900	2800	8.63	5.2	4.50	5.70	A+	A+++	4.74	
22		16	-	-	5.04	3.96	-	-	2.0	9.0	12.0	390	1900	2800	8.63	5.2	4.50	5.70	A+	A+++	4.74	
24		16	-	-	5.33	3.67	-	-	2.0	9.0	12.0	390	1900	2800	8.63	5.2	4.50	5.70	A+	A+++	4.74	
18		18	-	-	4.50	4.50	-	-	2.0	9.0	12.0	390	1900	2800	8.63	5.2	4.50	5.70	A+	A+++	4.74	
22		18	-	-	4.85	4.15	-	-	2.0	9.0	12.0	390	1900	2800	8.63	5.2	4.50	5.70	A+	A+++	4.74	
24		18	-	-	5.14	3.86	-	-	2.0	9.0	12.0	390	1900	2800	8.63	5.2	4.50	5.70	A+	A+++	4.74	
3 units operations		05	05	05	-	2.00	2.00	2.00	-	1.7	6.0	7.5	360	1330	1830	6.11	3.5	4.50	6.10	A+	A+++	4.51
		07	05	05	-	2.50	2.00	2.00	-	1.8	6.5	8.6	360	1420	2070	6.51	3.8	4.50	5.90	A+	A+++	4.58
		10	05	05	-	3.20	2.00	2.00	-	1.8	7.2	9.8	370	1560	2330	7.13	4.2	4.50	5.80	A+	A+++	4.62
		13	05	05	-	4.20	2.00	2.00	-	1.9	8.2	10.3	380	1750	2440	7.97	4.7	4.50	5.70	A+	A+++	4.69
		16	05	05	-	5.21	1.89	1.89	-	2.0	9.0	11.5	390	1900	2700	8.63	5.2	4.50	5.70	A+	A+++	4.74
		18	05	05	-	5.40	1.80	1.80	-	2.0	9.0	11.5	390	1900	2700	8.63	5.2	4.50	5.70	A+	A+++	4.74
		22	05	05	-	5.73	1.64	1.64	-	2.0	9.0	12.0	390	1900	2800	8.63	5.2	4.50	5.70	A+	A+++	4.74
	24	05	05	-	6.00	1.50	1.50	-	2.0	9.0	12.0	390	1900	2800	8.63	5.2	4.50	5.70	A+	A+++	4.74	
	07	07	05	-	2.50	2.50	2.00	-	1.8	7.0	9.7	370	1520	2310	6.95	4.0	4.50	5.90	A+	A+++	4.61	
	10	07	05	-	3.20	2.50	2.00	-	1.9	7.7	10.9	380	1650	2570	7.53	4.4	4.50	5.80	A+	A+++	4.67	
	13	07	05	-	4.20	2.50	2.00	-	2.0	8.7	11.4	390	1850	2680	8.41	5.0	4.50	5.70	A+	A+++	4.70	
	16	07	05	-	4.95	2.25	1.80	-	2.0	9.0	12.0	390	1900	2800	8.63	5.2	4.50	5.70	A+	A+++	4.74	
	18	07	05	-	5.14	2.14	1.71	-	2.0	9.0	12.0	390	1900	2800	8.63	5.2	4.50	5.70	A+	A+++	4.74	
	22	07	05	-	5.48	1.96	1.57	-	2.0	9.0	12.0	390	1900	2800	8.63	5.2	4.50	5.70	A+	A+++	4.74	
	24	07	05	-	5.76	1.80	1.44	-	2.0	9.0	12.0	390	1900	2800	8.63	5.2	4.50	5.70	A+	A+++	4.74	
	10	10	05	-	3.20	3.20	2.00	-	1.9	8.4	12.0	390	1790	2800	8.14	4.9	4.50	5.70	A+	A+++	4.69	
	13	10	05	-	4.02	3.06	1.91	-	2.0	9.0	12.0	390	1900	2800	8.63	5.2	4.50	5.70	A+	A+++	4.74	
	16	10	05	-	4.63	2.69	1.68	-	2.0	9.0	12.0	390	1900	2800	8.63	5.2	4.50	5.70	A+	A+++	4.74	
	18	10	05	-	4.82	2.57	1.61	-	2.0	9.0	12.0	390	1900	2800	8.63	5.2	4.50	5.70	A+	A+++	4.74	
	22	10	05	-	5.16	2.36	1.48	-	2.0	9.0	12.0	390	1900	2800	8.63	5.2	4.50	5.70	A+	A+++	4.74	
	24	10	05	-	5.45	2.18	1.36	-	2.0	9.0	12.0	390	1900	2800	8.63	5.2	4.50	5.70	A+	A+++	4.74	
	13	13	05	-	3.63	3.63	1.73	-	2.0	9.0	12.0	390	1900	2800	8.63	5.2	4.50	5.70	A+	A+++	4.74	
	16	13	05	-	4.23	3.23	1.54	-	2.0	9.0	12.0	390	1900	2800	8.63	5.2	4.50	5.70	A+	A+++	4.74	
	18	13	05	-	4.43	3.10	1.48	-	2.0	9.0	12.0	390	1900	2800	8.63	5.2	4.50	5.70	A+	A+++	4.74	
	22	13	05	-	4.77	2.86	1.36	-	2.0	9.0	12.0	390	1900	2800	8.63	5.2	4.50	5.70	A+	A+++	4.74	
	24	13	05	-	5.07	2.66	1.27	-	2.0	9.0	12.0	390	1900	2800	8.63	5.2	4.50	5.70	A+	A+++	4.74	
	16	16	05	-	3.81	3.81	1.38	-	2.0	9.0	12.0	390	1900	2800	8.63	5.2	4.50	5.70	A+	A+++	4.74	
	18	16	05	-	4.00	3.67	1.33	-	2.0	9.0	12.0	390	1900	2800	8.63	5.2	4.50	5.70	A+	A+++	4.74	
	22	16	05	-	4.34	3.41	1.24	-	2.0	9.0	12.0	390	1900	2800	8.63	5.2	4.50	5.70	A+	A+++	4.74	
	24	16	05	-	4.65	3.19	1.16	-	2.0	9.0	12.0	390	1900	2800	8.63	5.2	4.50	5.70	A+	A+++	4.74	
	18	18	05	-	3.86	3.86	1.29	-	2.0	9.0	12.0	390	1900	2800	8.63	5.2</						

**RAS-4M27G3AVG-E / TR - Performances in Heating mode**

Operating Status	Combination				Unit capacity (kW)				Heating capacity (kW)			Power input (W)			Operating current (A)		Lot.10		Label	COP	
	Unit A	Unit B	Unit C	Unit D	Unit A	Unit B	Unit C	Unit D	Min.	Nom.	Max.	Min.	Nom.	Max.	Nom.	Pdh	SCOP	SCOP Warm climate			
3 units operations	13	10	10	-	3.57	2.72	2.72	-	2.0	9.0	12.0	390	1900	2800	8.63	5.2	4.50	5.70	A+	A+++	4.74
	16	10	10	-	4.16	2.42	2.42	-	2.0	9.0	12.0	390	1900	2800	8.63	5.2	4.50	5.70	A+	A+++	4.74
	18	10	10	-	4.35	2.32	2.32	-	2.0	9.0	12.0	390	1900	2800	8.63	5.2	4.50	5.70	A+	A+++	4.74
	22	10	10	-	4.70	2.15	2.15	-	2.0	9.0	12.0	390	1900	2800	8.63	5.2	4.50	5.70	A+	A+++	4.74
	24	10	10	-	5.00	2.00	2.00	-	2.0	9.0	12.0	390	1900	2800	8.63	5.2	4.50	5.70	A+	A+++	4.74
	13	13	10	-	3.26	3.26	2.48	-	2.0	9.0	12.0	390	1900	2800	8.63	5.2	4.50	5.70	A+	A+++	4.74
	16	13	10	-	3.84	2.93	2.23	-	2.0	9.0	12.0	390	1900	2800	8.63	5.2	4.50	5.70	A+	A+++	4.74
	18	13	10	-	4.03	2.82	2.15	-	2.0	9.0	12.0	390	1900	2800	8.63	5.2	4.50	5.70	A+	A+++	4.74
	22	13	10	-	4.38	2.63	2.00	-	2.0	9.0	12.0	390	1900	2800	8.63	5.2	4.50	5.70	A+	A+++	4.74
	24	13	10	-	4.68	2.45	1.87	-	2.0	9.0	12.0	390	1900	2800	8.63	5.2	4.50	5.70	A+	A+++	4.74
	16	16	10	-	3.49	3.49	2.03	-	2.0	9.0	12.0	390	1900	2800	8.63	5.2	4.50	5.70	A+	A+++	4.74
	18	16	10	-	3.67	3.37	1.96	-	2.0	9.0	12.0	390	1900	2800	8.63	5.2	4.50	5.70	A+	A+++	4.74
	22	16	10	-	4.01	3.15	1.83	-	2.0	9.0	12.0	390	1900	2800	8.63	5.2	4.50	5.70	A+	A+++	4.74
	24	16	10	-	4.31	2.96	1.72	-	2.0	9.0	12.0	390	1900	2800	8.63	5.2	4.50	5.70	A+	A+++	4.74
	18	18	10	-	3.55	3.55	1.89	-	2.0	9.0	12.0	390	1900	2800	8.63	5.2	4.50	5.70	A+	A+++	4.74
	22	18	10	-	3.89	3.33	1.78	-	2.0	9.0	12.0	390	1900	2800	8.63	5.2	4.50	5.70	A+	A+++	4.74
	24	18	10	-	4.19	3.14	1.67	-	2.0	9.0	12.0	390	1900	2800	8.63	5.2	4.50	5.70	A+	A+++	4.74
	13	13	13	-	3.00	3.00	3.00	-	2.0	9.0	12.0	390	1900	2800	8.63	5.2	4.50	5.70	A+	A+++	4.74
	16	13	13	-	3.56	2.72	2.72	-	2.0	9.0	12.0	390	1900	2800	8.63	5.2	4.50	5.70	A+	A+++	4.74
	18	13	13	-	3.75	2.63	2.63	-	2.0	9.0	12.0	390	1900	2800	8.63	5.2	4.50	5.70	A+	A+++	4.74
	22	13	13	-	4.09	2.45	2.45	-	2.0	9.0	12.0	390	1900	2800	8.63	5.2	4.50	5.70	A+	A+++	4.74
	24	13	13	-	4.39	2.30	2.30	-	2.0	9.0	12.0	390	1900	2800	8.63	5.2	4.50	5.70	A+	A+++	4.74
	16	16	13	-	3.26	3.26	2.49	-	2.0	9.0	12.0	390	1900	2800	8.63	5.2	4.50	5.70	A+	A+++	4.74
	18	16	13	-	3.44	3.15	2.41	-	2.0	9.0	12.0	390	1900	2800	8.63	5.2	4.50	5.70	A+	A+++	4.74
	22	16	13	-	3.77	2.96	2.26	-	2.0	9.0	12.0	390	1900	2800	8.63	5.2	4.50	5.70	A+	A+++	4.74
	24	16	13	-	4.07	2.80	2.14	-	2.0	9.0	12.0	390	1900	2800	8.63	5.2	4.50	5.70	A+	A+++	4.74
	18	18	13	-	3.33	3.33	2.33	-	2.0	9.0	12.0	390	1900	2800	8.63	5.2	4.50	5.70	A+	A+++	4.74
	22	18	13	-	3.66	3.14	2.20	-	2.0	9.0	12.0	390	1900	2800	8.63	5.2	4.50	5.70	A+	A+++	4.74
	16	16	16	-	3.00	3.00	3.00	-	2.0	9.0	12.0	390	1900	2800	8.63	5.2	4.50	5.70	A+	A+++	4.74
	18	16	16	-	3.18	2.91	2.91	-	2.0	9.0	12.0	390	1900	2800	8.63	5.2	4.50	5.70	A+	A+++	4.74
	22	16	16	-	3.50	2.75	2.75	-	2.0	9.0	12.0	390	1900	2800	8.63	5.2	4.50	5.70	A+	A+++	4.74
	05	05	05	05	2.00	2.00	2.00	2.00	1.9	8.0	10.0	380	1710	2370	7.79	4.6	4.30	5.40	A+	A+++	4.68
07	05	05	05	2.50	2.00	2.00	2.00	2.0	8.5	11.1	390	1810	2610	8.23	4.9	4.40	5.50	A+	A+++	4.70	
10	05	05	05	3.13	1.96	1.96	1.96	2.0	9.0	12.0	390	1900	2800	8.63	5.2	4.50	5.60	A+	A+++	4.74	
13	05	05	05	3.71	1.76	1.76	1.76	2.0	9.0	12.0	390	1900	2800	8.63	5.2	4.50	5.60	A+	A+++	4.74	
16	05	05	05	4.30	1.57	1.57	1.57	2.0	9.0	12.0	390	1900	2800	8.63	5.2	4.50	5.60	A+	A+++	4.74	
18	05	05	05	4.50	1.50	1.50	1.50	2.0	9.0	12.0	390	1900	2800	8.63	5.2	4.50	5.60	A+	A+++	4.74	
22	05	05	05	4.85	1.38	1.38	1.38	2.0	9.0	12.0	390	1900	2800	8.63	5.2	4.50	5.60	A+	A+++	4.74	
24	05	05	05	5.14	1.29	1.29	1.29	2.0	9.0	12.0	390	1900	2800	8.63	5.2	4.50	5.60	A+	A+++	4.74	
07	07	05	05	2.50	2.50	2.00	2.00	2.0	9.0	12.0	390	1900	2800	8.63	5.2	4.50	5.60	A+	A+++	4.74	
10	07	05	05	2.97	2.32	1.86	1.86	2.0	9.0	12.0	390	1900	2800	8.63	5.2	4.50	5.60	A+	A+++	4.74	
13	07	05	05	3.53	2.10	1.68	1.68	2.0	9.0	12.0	390	1900	2800	8.63	5.2	4.50	5.60	A+	A+++	4.74	
16	07	05	05	4.13	1.88	1.50	1.50	2.0	9.0	12.0	390	1900	2800	8.63	5.2	4.50	5.60	A+	A+++	4.74	
18	07	05	05	4.32	1.80	1.44	1.44	2.0	9.0	12.0	390	1900	2800	8.63	5.2	4.50	5.60	A+	A+++	4.74	
22	07	05	05	4.67	1.67	1.33	1.33	2.0	9.0	12.0	390	1900	2800	8.63	5.2	4.50	5.60	A+	A+++	4.74	
24	07	05	05	4.97	1.55	1.24	1.24	2.0	9.0	12.0	390	1900	2800	8.63	5.2	4.50	5.60	A+	A+++	4.74	
10	10	05	05	2.77	2.77	1.73	1.73	2.0	9.0	12.0	390	1900	2800	8.63	5.2	4.50	5.60	A+	A+++	4.74	
13	10	05	05	3.32	2.53	1.58	1.58	2.0	9.0	12.0	390	1900	2800	8.63	5.2	4.50	5.60	A+	A+++	4.74	
16	10	05	05	3.90	2.27	1.42	1.42	2.0	9.0	12.0	390	1900	2800	8.63	5.2	4.50	5.60	A+	A+++	4.74	
18	10	05	05	4.09	2.18	1.36	1.36	2.0	9.0	12.0	390	1900	2800	8.63	5.2	4.50	5.60	A+	A+++	4.74	
22	10	05	05	4.44	2.03	1.27	1.27	2.0	9.0	12.0	390	1900	2800	8.63	5.2	4.50	5.60	A+	A+++	4.74	
24	10	05	05	4.74	1.89	1.18	1.18	2.0	9.0	12.0	390	1900	2800	8.63	5.2	4.50	5.60	A+	A+++	4.74	
13	13	05	05	3.05	3.05	1.45	1.45	2.0	9.0	12.0	390	1900	2800	8.63	5.2	4.50	5.60	A+	A+++	4.74	
16	13	05	05	3.61	2.76	1.31	1.31	2.0	9.0	12.0	390	1900	2800	8.63	5.2	4.50	5.60	A+	A+++	4.74	
18	13	05	05	3.80	2.66	1.27	1.27	2.0	9.0	12.0	390	1900	2800	8.63	5.2	4.50	5.60	A+	A+++	4.74	
22	13	05	05	4.14	2.49	1.18	1.18	2.0	9.0	12.0	390	1900	2800	8.63	5.2	4.50	5.60	A+	A+++	4.74	
24	13	05	05	4.44	2.33	1.11	1.11	2.0	9.0	12.0	390	1900	2800	8.63	5.2	4.50	5.60	A+	A+++	4.74	
16	16	05	05	3.30	3.30	1.20	1.20	2.0	9.0	12.0	390	1900	2800	8.63	5.2	4.50	5.60	A+	A+++	4.74	
18	16	05	05	3.48	3.19	1.16	1.16	2.0	9.0	12.0	390	1900	2800	8.63	5.2	4.50	5.60	A+	A+++	4.74	
22	16	05	05	3.38	3.38	1.13	1.13	2.0	9.0	12.0	390	1900	2800	8.63	5.2	4.50	5.60	A+	A+++	4.74	
07	07	07	05	2.37	2.37	2.37	1.89	2.0	9.0	12.0	390	1900	2800	8.63	5.2	4.50	5.60	A+	A+++	4.74	
10	07	07	05	2.82	2.21	2.21	1.76	2.0	9.0	12.0	390	1900	2800	8.63	5.2	4.50	5.60	A+	A+++	4.74	
13	07	07	05	3.38	2.01	2.01	1.61	2.0	9.0	12.0	390	1900	2800	8.63	5.2	4.50	5.60	A+	A+++	4.74	
16	07	07	05	3.96	1.80	1.80	1.44	2.0	9.0	12.0	390	1900	2800	8.63	5.2	4.50	5.60	A+	A+++	4.74	
18	07	07	05	4.15	1.73	1.73	1.38	2.0	9.0	12.0	390	1900	2800	8.63	5.2	4.50	5.60	A+	A+++	4.74	
22	07	07	05	4.50	1.61	1.61	1.29	2.0	9.0	12.0	390	1900	2800	8.63	5.2	4.50	5.60	A+	A+++	4.74	
24	07	07	05	4.80	1.50	1.50	1.20	2.0	9.0	12.0	390	1900	2800	8.63	5.2	4.50	5.60	A+	A+++	4.74	
10	10	07	05	2.64	2.64	2.06	1.65	2.0	9.0	12.0	390	1900	2800	8.63	5.2	4.50	5.60	A+	A+++	4.74	
13	10	07	05	3.18	2.42	1.89	1.51	2.0	9.0	12.0	390	1900	2800	8.63	5.2	4.50	5.60	A+	A+++	4.74	
16	10	07	05	3.75	2.18	1.70	1.36	2.0	9												





**RAS-4M27G3AVG-E / TR - Performances in Heating mode**

Operating Status	Combination				Unit capacity (kW)				Heating capacity (kW)			Power input (W)			Operating current (A)		Lot.10		Label	COP		
	Unit A	Unit B	Unit C	Unit D	Unit A	Unit B	Unit C	Unit D	Min.	Nom.	Max.	Min.	Nom.	Max.	Nom.	PdH	SCOP	SCOP Warm climate			Average climate	Warm climate
Heating, 230 V	4 units operations	07	07	07	07	2.25	2.25	2.25	2.25	2.0	9.0	12.0	390	1900	2800	8.63	5.2	4.50	5.60	A+	A+++	4.74
		10	07	07	07	2.69	2.10	2.10	2.10	2.0	9.0	12.0	390	1900	2800	8.63	5.2	4.50	5.60	A+	A+++	4.74
		13	07	07	07	3.23	1.92	1.92	1.92	2.0	9.0	12.0	390	1900	2800	8.63	5.2	4.50	5.60	A+	A+++	4.74
		16	07	07	07	3.81	1.73	1.73	1.73	2.0	9.0	12.0	390	1900	2800	8.63	5.2	4.50	5.60	A+	A+++	4.74
		18	07	07	07	4.00	1.67	1.67	1.67	2.0	9.0	12.0	390	1900	2800	8.63	5.2	4.50	5.60	A+	A+++	4.74
		22	07	07	07	4.34	1.55	1.55	1.55	2.0	9.0	12.0	390	1900	2800	8.63	5.2	4.50	5.60	A+	A+++	4.74
		24	07	07	07	4.65	1.45	1.45	1.45	2.0	9.0	12.0	390	1900	2800	8.63	5.2	4.50	5.60	A+	A+++	4.74
		10	10	07	07	2.53	2.53	1.97	1.97	2.0	9.0	12.0	390	1900	2800	8.63	5.2	4.50	5.60	A+	A+++	4.74
		13	10	07	07	3.05	2.32	1.81	1.81	2.0	9.0	12.0	390	1900	2800	8.63	5.2	4.50	5.60	A+	A+++	4.74
		16	10	07	07	3.61	2.10	1.64	1.64	2.0	9.0	12.0	390	1900	2800	8.63	5.2	4.50	5.60	A+	A+++	4.74
		18	10	07	07	3.80	2.03	1.58	1.58	2.0	9.0	12.0	390	1900	2800	8.63	5.2	4.50	5.60	A+	A+++	4.74
		22	10	07	07	4.14	1.89	1.48	1.48	2.0	9.0	12.0	390	1900	2800	8.63	5.2	4.50	5.60	A+	A+++	4.74
		24	10	07	07	4.44	1.78	1.39	1.39	2.0	9.0	12.0	390	1900	2800	8.63	5.2	4.50	5.60	A+	A+++	4.74
		13	13	07	07	2.82	2.82	1.68	1.68	2.0	9.0	12.0	390	1900	2800	8.63	5.2	4.50	5.60	A+	A+++	4.74
		16	13	07	07	3.37	2.57	1.53	1.53	2.0	9.0	12.0	390	1900	2800	8.63	5.2	4.50	5.60	A+	A+++	4.74
		18	13	07	07	3.55	2.49	1.48	1.48	2.0	9.0	12.0	390	1900	2800	8.63	5.2	4.50	5.60	A+	A+++	4.74
		22	13	07	07	3.89	2.33	1.39	1.39	2.0	9.0	12.0	390	1900	2800	8.63	5.2	4.50	5.60	A+	A+++	4.74
		24	13	07	07	4.19	2.20	1.31	1.31	2.0	9.0	12.0	390	1900	2800	8.63	5.2	4.50	5.60	A+	A+++	4.74
		16	16	07	07	3.09	3.09	1.41	1.41	2.0	9.0	12.0	390	1900	2800	8.63	5.2	4.50	5.60	A+	A+++	4.74
		18	16	07	07	3.27	3.00	1.36	1.36	2.0	9.0	12.0	390	1900	2800	8.63	5.2	4.50	5.60	A+	A+++	4.74
		18	18	07	07	3.18	3.18	1.32	1.32	2.0	9.0	12.0	390	1900	2800	8.63	5.2	4.50	5.60	A+	A+++	4.74
		10	10	10	07	2.38	2.38	2.38	1.86	2.0	9.0	12.0	390	1900	2800	8.63	5.2	4.50	5.60	A+	A+++	4.74
		13	10	10	07	2.89	2.20	2.20	1.72	2.0	9.0	12.0	390	1900	2800	8.63	5.2	4.50	5.60	A+	A+++	4.74
		16	10	10	07	3.44	2.00	2.00	1.56	2.0	9.0	12.0	390	1900	2800	8.63	5.2	4.50	5.60	A+	A+++	4.74
		18	10	10	07	3.62	1.93	1.93	1.51	2.0	9.0	12.0	390	1900	2800	8.63	5.2	4.50	5.60	A+	A+++	4.74
		22	10	10	07	3.96	1.81	1.81	1.42	2.0	9.0	12.0	390	1900	2800	8.63	5.2	4.50	5.60	A+	A+++	4.74
		24	10	10	07	4.26	1.70	1.70	1.33	2.0	9.0	12.0	390	1900	2800	8.63	5.2	4.50	5.60	A+	A+++	4.74
		13	13	10	07	2.68	2.68	2.04	1.60	2.0	9.0	12.0	390	1900	2800	8.63	5.2	4.50	5.60	A+	A+++	4.74
		16	13	10	07	3.21	2.45	1.87	1.46	2.0	9.0	12.0	390	1900	2800	8.63	5.2	4.50	5.60	A+	A+++	4.74
		18	13	10	07	3.40	2.38	1.81	1.42	2.0	9.0	12.0	390	1900	2800	8.63	5.2	4.50	5.60	A+	A+++	4.74
		22	13	10	07	3.73	2.24	1.70	1.33	2.0	9.0	12.0	390	1900	2800	8.63	5.2	4.50	5.60	A+	A+++	4.74
		24	13	10	07	4.02	2.11	1.61	1.26	2.0	9.0	12.0	390	1900	2800	8.63	5.2	4.50	5.60	A+	A+++	4.74
		16	16	10	07	2.96	2.96	1.72	1.35	2.0	9.0	12.0	390	1900	2800	8.63	5.2	4.50	5.60	A+	A+++	4.74
		18	16	10	07	3.14	2.88	1.67	1.31	2.0	9.0	12.0	390	1900	2800	8.63	5.2	4.50	5.60	A+	A+++	4.74
		18	18	10	07	3.05	3.05	1.63	1.27	2.0	9.0	12.0	390	1900	2800	8.63	5.2	4.50	5.60	A+	A+++	4.74
		13	13	13	07	2.50	2.50	2.50	1.49	2.0	9.0	12.0	390	1900	2800	8.63	5.2	4.50	5.60	A+	A+++	4.74
		16	13	13	07	3.02	2.30	2.30	1.37	2.0	9.0	12.0	390	1900	2800	8.63	5.2	4.50	5.60	A+	A+++	4.74
		18	13	13	07	3.20	2.24	2.24	1.33	2.0	9.0	12.0	390	1900	2800	8.63	5.2	4.50	5.60	A+	A+++	4.74
		16	16	13	07	2.80	2.80	2.14	1.27	2.0	9.0	12.0	390	1900	2800	8.63	5.2	4.50	5.60	A+	A+++	4.74
		18	16	13	07	2.97	2.72	2.08	1.24	2.0	9.0	12.0	390	1900	2800	8.63	5.2	4.50	5.60	A+	A+++	4.74
		10	10	10	10	2.25	2.25	2.25	2.25	2.0	9.0	12.0	390	1900	2800	8.63	5.2	4.50	5.60	A+	A+++	4.74
		13	10	10	10	2.74	2.09	2.09	2.09	2.0	9.0	12.0	390	1900	2800	8.63	5.2	4.50	5.60	A+	A+++	4.74
		16	10	10	10	3.28	1.91	1.91	1.91	2.0	9.0	12.0	390	1900	2800	8.63	5.2	4.50	5.60	A+	A+++	4.74
		18	10	10	10	3.46	1.85	1.85	1.85	2.0	9.0	12.0	390	1900	2800	8.63	5.2	4.50	5.60	A+	A+++	4.74
		22	10	10	10	3.80	1.73	1.73	1.73	2.0	9.0	12.0	390	1900	2800	8.63	5.2	4.50	5.60	A+	A+++	4.74
		24	10	10	10	4.09	1.64	1.64	1.64	2.0	9.0	12.0	390	1900	2800	8.63	5.2	4.50	5.60	A+	A+++	4.74
		13	13	10	10	2.55	2.55	1.95	1.95	2.0	9.0	12.0	390	1900	2800	8.63	5.2	4.50	5.60	A+	A+++	4.74
		16	13	10	10	3.07	2.35	1.79	1.79	2.0	9.0	12.0	390	1900	2800	8.63	5.2	4.50	5.60	A+	A+++	4.74
		18	13	10	10	3.25	2.28	1.73	1.73	2.0	9.0	12.0	390	1900	2800	8.63	5.2	4.50	5.60	A+	A+++	4.74
		16	16	10	10	2.84	2.84	1.66	1.66	2.0	9.0	12.0	390	1900	2800	8.63	5.2	4.50	5.60	A+	A+++	4.74
18	16	10	10	3.02	2.77	1.61	1.61	2.0	9.0	12.0	390	1900	2800	8.63	5.2	4.50	5.60	A+	A+++	4.74		
13	13	13	10	2.39	2.39	2.39	1.82	2.0	9.0	12.0	390	1900	2800	8.63	5.2	4.50	5.60	A+	A+++	4.74		
16	13	13	10	2.89	2.21	2.21	1.68	2.0	9.0	12.0	390	1900	2800	8.63	5.2	4.50	5.60	A+	A+++	4.74		
18	13	13	10	3.07	2.15	2.15	1.64	2.0	9.0	12.0	390	1900	2800	8.63	5.2	4.50	5.60	A+	A+++	4.74		
13	13	13	13	2.25	2.25	2.25	2.25	2.0	9.0	12.0	390	1900	2800	8.63	5.2	4.50	5.60	A+	A+++	4.74		

**RAS-5M34G3AVG-E / TR - Performances in Cooling mode**

Operating status	Combination					Unit capacity (kW)					Cooling capacity (kW)			Power input (W)			Operating current (A)		Lot.10		EER
	Unit A	Unit B	Unit C	Unit D	Unit E	Unit A	Unit B	Unit C	Unit D	Unit E	Min.	Nom.	Max.	Min.	Nom.	Max.	Nom.	Pdc	SEER	Class	
1 unit operation	05	-	-	-	-	1.50	-	-	-	-	1.4	1.5	2.0	630	640	650	-	-	-	-	-
	07	-	-	-	-	2.00	-	-	-	-	1.5	2.0	2.9	640	650	700	-	-	-	-	-
	10	-	-	-	-	2.50	-	-	-	-	1.5	2.5	3.2	640	750	950	-	-	-	-	-
	13	-	-	-	-	3.50	-	-	-	-	1.7	3.5	4.1	640	1200	1520	-	-	-	-	-
	16	-	-	-	-	4.60	-	-	-	-	1.8	4.6	5.3	640	1650	2000	-	-	-	-	-
	18	-	-	-	-	5.00	-	-	-	-	1.9	5.0	6.0	640	1950	2100	-	-	-	-	-
	22	-	-	-	-	6.10	-	-	-	-	2.0	6.1	6.7	660	2020	2500	-	-	-	-	-
	24	-	-	-	-	7.00	-	-	-	-	2.1	7.0	7.7	660	2390	2960	-	-	-	-	-
	05	05	-	-	-	1.50	1.50	-	-	-	1.6	3.0	4.0	640	1210	1480	3.96	3.0	5.40	A	3.53
	07	05	-	-	-	2.00	1.50	-	-	-	1.7	3.5	4.9	640	1310	1625	4.54	3.5	5.60	A+	3.57
10	05	-	-	-	2.50	1.50	-	-	-	1.7	4.0	5.2	640	1440	1810	5.08	4.0	5.80	A+	3.64	
13	05	-	-	-	3.50	1.50	-	-	-	1.9	5.0	6.1	640	1620	1980	6.20	5.0	6.20	A++	3.70	
16	05	-	-	-	4.60	1.50	-	-	-	2.0	6.1	7.3	640	1810	2160	7.44	6.1	6.50</			

RAS-5M34G3AVG-E / TR - Performances in Cooling mode

Operating status	Combination					Unit capacity (kW)					Cooling capacity (kW)			Power input (W)		Operating current (A)		Lot.10 SEER	Class	EER	
	Unit A	Unit B	Unit C	Unit D	Unit E	Unit A	Unit B	Unit C	Unit D	Unit E	Min.	Nom.	Max.	Min.	Max.	Nom.	Pdc				
2 units operations	18	18	-	-	-	5.00	5.00	-	-	-	2.5	10.0	11.5	700	2550	2750	11.75	10.0	7.40	A++	3.85
	22	18	-	-	-	5.50	4.50	-	-	-	2.5	10.0	11.5	700	2550	2750	11.75	10.0	7.40	A++	3.85
	24	18	-	-	-	5.83	4.17	-	-	-	2.5	10.0	11.5	700	2550	2750	11.75	10.0	7.40	A++	3.85
	22	22	-	-	-	5.00	5.00	-	-	-	2.5	10.0	11.5	700	2570	2770	11.75	10.0	7.40	A++	3.85
	24	22	-	-	-	5.34	4.66	-	-	-	2.5	10.0	11.5	700	2570	2770	11.75	10.0	7.40	A++	3.85
	24	24	-	-	-	5.00	5.00	-	-	-	2.5	10.0	11.5	700	2600	2800	11.75	10.0	7.40	A++	3.85
	05	05	05	-	-	1.50	1.50	1.50	-	-	1.8	4.5	6.0	950	1840	1910	5.66	4.5	5.90	A+	3.66
	07	05	05	-	-	2.00	1.50	1.50	-	-	1.9	5.0	6.9	950	1930	2060	6.20	5.0	6.00	A+	3.70
	10	05	05	-	-	2.50	1.50	1.50	-	-	1.9	5.5	7.2	950	2040	2210	6.77	5.5	6.20	A++	3.72
	13	05	05	-	-	3.50	1.50	1.50	-	-	2.1	6.5	8.1	950	2300	2410	7.88	6.5	6.50	A++	3.76
16	05	05	-	-	4.60	1.50	1.50	-	-	2.2	7.6	9.3	950	2400	2660	9.07	7.6	6.80	A++	3.80	
18	05	05	-	-	5.00	1.50	1.50	-	-	2.3	8.0	10.0	950	2410	2690	9.52	8.0	6.90	A++	3.81	
22	05	05	-	-	6.10	1.50	1.50	-	-	2.4	9.1	10.7	950	2410	2720	10.76	9.1	7.10	A++	3.82	
24	05	05	-	-	7.00	1.50	1.50	-	-	2.5	10.0	11.5	950	2410	2720	11.75	10.0	7.30	A++	3.85	
07	07	05	-	-	2.00	2.00	1.50	-	-	1.9	5.5	7.8	950	2010	2170	6.77	5.5	6.20	A++	3.72	
10	07	05	-	-	2.50	2.00	1.50	-	-	2.0	6.0	8.1	950	2120	2330	7.30	6.0	6.30	A++	3.75	
13	07	05	-	-	3.50	2.00	1.50	-	-	2.1	7.0	9.0	950	2400	2230	8.41	7.0	6.60	A++	3.78	
16	07	05	-	-	4.60	2.00	1.50	-	-	2.3	8.1	10.2	950	2410	2690	9.65	8.1	6.90	A++	3.80	
18	07	05	-	-	5.00	2.00	1.50	-	-	2.3	8.5	10.9	950	2410	2720	10.10	8.5	7.00	A++	3.81	
22	07	05	-	-	6.10	2.00	1.50	-	-	2.5	9.6	11.5	950	2410	2720	11.30	9.6	7.20	A++	3.84	
24	07	05	-	-	6.67	1.90	1.43	-	-	2.5	10.0	11.5	950	2430	2760	11.75	10.0	7.30	A++	3.85	
10	10	05	-	-	2.50	2.50	1.50	-	-	2.1	6.5	8.4	950	2400	2230	7.88	6.5	6.50	A++	3.76	
13	10	05	-	-	3.50	2.50	1.50	-	-	2.2	7.5	9.3	950	2410	2690	8.99	7.5	6.80	A++	3.79	
16	10	05	-	-	4.60	2.50	1.50	-	-	2.3	8.6	10.5	950	2410	2720	10.18	8.6	7.00	A++	3.82	
18	10	05	-	-	5.00	2.50	1.50	-	-	2.4	9.0	11.2	950	2410	2720	10.63	9.0	7.10	A++	3.83	
22	10	05	-	-	6.00	2.50	1.50	-	-	2.5	10.0	11.5	950	2430	2760	11.75	10.0	7.30	A++	3.85	
24	10	05	-	-	6.36	2.27	1.36	-	-	2.5	10.0	11.5	950	2430	2760	11.75	10.0	7.30	A++	3.85	
13	13	05	-	-	3.50	3.50	1.50	-	-	2.3	8.5	10.2	950	2410	2720	10.10	8.5	7.00	A++	3.81	
16	13	05	-	-	4.60	3.50	1.50	-	-	2.5	9.6	11.4	950	2410	2720	11.30	9.6	7.30	A++	3.84	
18	13	05	-	-	5.00	3.50	1.50	-	-	2.5	10.0	11.5	950	2430	2760	11.75	10.0	7.30	A++	3.85	
22	13	05	-	-	5.50	3.15	1.35	-	-	2.5	10.0	11.5	950	2430	2760	11.75	10.0	7.30	A++	3.85	
24	13	05	-	-	5.83	2.92	1.25	-	-	2.5	10.0	11.5	950	2430	2760	11.75	10.0	7.30	A++	3.85	
16	16	05	-	-	4.30	4.30	1.40	-	-	2.5	10.0	11.5	950	2430	2760	11.75	10.0	7.30	A++	3.85	
18	16	05	-	-	4.50	4.14	1.35	-	-	2.5	10.0	11.5	950	2430	2760	11.75	10.0	7.30	A++	3.85	
22	16	05	-	-	5.00	3.77	1.23	-	-	2.5	10.0	11.5	950	2440	2780	11.75	10.0	7.30	A++	3.85	
24	16	05	-	-	5.34	3.51	1.15	-	-	2.5	10.0	11.5	950	2440	2780	11.75	10.0	7.30	A++	3.85	
18	18	05	-	-	4.35	4.35	1.30	-	-	2.5	10.0	11.5	950	2430	2760	11.75	10.0	7.30	A++	3.85	
22	18	05	-	-	4.84	3.97	1.19	-	-	2.5	10.0	11.5	950	2440	2780	11.75	10.0	7.30	A++	3.85	
24	18	05	-	-	5.19	3.70	1.11	-	-	2.5	10.0	11.5	950	2440	2780	11.75	10.0	7.30	A++	3.85	
22	22	05	-	-	4.45	4.45	1.09	-	-	2.5	10.0	11.5	950	2440	2780	11.75	10.0	7.30	A++	3.85	
24	22	05	-	-	4.79	4.18	1.03	-	-	2.5	10.0	11.5	950	2450	2810	11.75	10.0	7.30	A++	3.85	
24	24	05	-	-	4.52	4.52	0.97	-	-	2.5	10.0	11.5	950	2450	2830	11.75	10.0	7.30	A++	3.85	
07	07	07	-	-	2.00	2.00	2.00	-	-	2.0	6.0	8.7	950	2100	2500	7.30	6.0	6.30	A++	3.75	
10	07	07	-	-	2.50	2.00	2.00	-	-	2.1	6.5	9.0	950	2400	2660	7.88	6.5	6.50	A++	3.76	
13	07	07	-	-	3.50	2.00	2.00	-	-	2.2	7.5	9.9	960	2410	2690	8.99	7.5	6.80	A++	3.79	
16	07	07	-	-	4.60	2.00	2.00	-	-	2.3	8.6	11.1	960	2410	2720	10.18	8.6	7.00	A++	3.82	
18	07	07	-	-	5.00	2.00	2.00	-	-	2.4	9.0	11.5	960	2410	2720	10.63	9.0	7.10	A++	3.83	
22	07	07	-	-	6.04	1.98	1.98	-	-	2.5	10.0	11.5	970	2430	2760	11.75	10.0	7.30	A++	3.85	
24	07	07	-	-	6.36	1.82	1.82	-	-	2.5	10.0	11.5	970	2430	2760	11.75	10.0	7.30	A++	3.85	
10	10	07	-	-	2.50	2.50	2.00	-	-	2.1	7.0	9.3	950	2400	2660	8.41	7.0	6.60	A++	3.78	
13	10	07	-	-	3.50	2.50	2.00	-	-	2.3	8.0	10.2	960	2410	2690	9.52	8.0	6.90	A++	3.81	
16	10	07	-	-	4.60	2.50	2.00	-	-	2.4	9.1	11.4	960	2410	2720	10.76	9.1	7.10	A++	3.82	
18	10	07	-	-	5.00	2.50	2.00	-	-	2.4	9.5	11.5	960	2410	2720	11.21	9.5	7.20	A++	3.83	
22	10	07	-	-	5.75	2.36	1.89	-	-	2.5	10.0	11.5	970	2430	2760	11.75	10.0	7.30	A++	3.85	
24	10	07	-	-	6.09	2.17	1.74	-	-	2.5	10.0	11.5	970	2430	2760	11.75	10.0	7.30	A++	3.85	
13	13	07	-	-	3.50	3.50	2.00	-	-	2.4	9.0	11.1	960	2410	2720	10.63	9.0	7.10	A++	3.83	
16	13	07	-	-	4.55	3.47	1.98	-	-	2.5	10.0	11.5	970	2430	2760	11.75	10.0	7.30	A++	3.85	
18	13	07	-	-	4.76	3.33	1.90	-	-	2.5	10.0	11.5	970	2430	2760	11.75	10.0	7.30	A++	3.85	
22	13	07	-	-	5.26	3.02	1.72	-	-	2.5	10.0	11.5	970	2430	2760	11.75	10.0	7.30	A++	3.85	
24	13	07	-	-	5.60	2.80	1.60	-	-	2.5	10.0	11.5	970	2440	2780	11.75	10.0	7.30	A++	3.85	
16	16	07	-	-	4.11	4.11	1.79	-	-	2.5	10.0	11.5	970	2430	2760	11.75	10.0	7.30	A++	3.85	
18	16	07	-	-	4.31	3.97	1.72	-	-	2.5	10.0	11.5	970	2430	2760	11.75	10.0	7.30	A++	3.85	
22	16	07	-	-	4.80	3.62	1.57	-	-	2.5	10.0	11.5	970	2440	2780	11.75	10.0	7.30	A++	3.85	
24	16	07	-	-	5.15	3.38	1.47	-	-	2.5	10.0	11.5	970	2440	2780	11.75	10.0	7.30	A++	3.85	
18	18	07	-	-	4.17	4.17	1.67	-	-	2.5	10.0	11.5	970	2440	2780	11.75	10.0	7.30	A++	3.85	
22	18	07	-	-	4.66	3.82	1.53	-	-	2.5	10.0	11.5	970	2440	2780	11.75	10.0	7.30	A++	3.85	
24	18	07	-	-	5.00	3.57	1.43	-	-	2.5	10.0	11.5	970	2440	2780	11.75	10.0	7.30	A++	3.85	
22	22	07	-	-	4.30	4.30	1.41	-	-	2.5	10.0	11.5	970	2440	2810	11.75	10.0	7.30	A++	3.85	
24	22	07	-	-	4.64	4.04	1.32	-	-	2.5	10.0	11.5	970	2440	2830	11.75	10.0	7.30	A++	3.85	
24	24	07	-	-	4.38	4.38	1.25	-	-	2.5	10.0	11.5	970	2470	2860	11.75	10.0	7.30	A++	3.85	
10	10	10	-	-	2.50	2.50	2.50	-	-	2.2	7.5	9.6	950	2400	2720	8.99	7.5	6.80	A++	3.79	
13	10	10	-	-	3.50	2.50	2.50	-	-	2.3	8.5	10.5	960	2410	2740	10.10	8.5	7.00	A++	3.81	
16	10																				



**RAS-5M34G3AVG-E / TR - Performances in Cooling mode**

Operating status	Combination					Unit capacity (kW)					Cooling capacity (kW)			Power input (W)			Operating current (A)		Loi.10 SEER	Class	EER Nom.
	Unit A	Unit B	Unit C	Unit D	Unit E	Unit A	Unit B	Unit C	Unit D	Unit E	Min.	Nom.	Max.	Min.	Nom.	Max.	Nom.	Pdc			
3 units operations	18	18	13	-	-	3.70	3.70	2.59	-	-	2.5	10.0	11.5	970	2440	2830	11.75	10.0	7.30	A++	3.85
	22	18	13	-	-	4.18	3.42	2.40	-	-	2.5	10.0	11.5	970	2440	2900	11.75	10.0	7.30	A++	3.85
	24	18	13	-	-	4.52	3.23	2.26	-	-	2.5	10.0	11.5	970	2440	2900	11.75	10.0	7.30	A++	3.85
	16	16	16	-	-	3.33	3.33	3.33	-	-	2.5	10.0	11.5	980	2450	2900	11.75	10.0	7.30	A++	3.85
4 units operations	05	05	05	05	-	1.50	1.50	1.50	1.50	-	2.0	6.0	8.0	930	1840	2270	7.30	6.0	6.20	A++	3.75
	07	05	05	05	-	2.00	1.50	1.50	1.50	-	2.1	6.5	8.9	930	2020	2400	7.88	6.5	6.40	A++	3.76
	10	05	05	05	-	2.50	1.50	1.50	1.50	-	2.1	7.0	9.2	930	2250	2580	8.41	7.0	6.60	A++	3.78
	13	05	05	05	-	3.50	1.50	1.50	1.50	-	2.3	8.0	10.1	930	2500	2800	9.52	8.0	6.80	A++	3.81
	16	05	05	05	-	4.60	1.50	1.50	1.50	-	2.4	9.1	11.3	930	2710	2820	10.76	9.1	7.10	A++	3.82
	18	05	05	05	-	5.00	1.50	1.50	1.50	-	2.4	9.5	11.5	930	2720	2840	11.21	9.5	7.10	A++	3.83
	22	05	05	05	-	5.75	1.42	1.42	1.42	-	2.5	10.0	11.5	930	2720	2850	11.75	10.0	7.20	A++	3.85
	24	05	05	05	-	6.09	1.30	1.30	1.30	-	2.5	10.0	11.5	930	2730	2880	11.75	10.0	7.20	A++	3.85
	07	07	05	05	-	2.00	2.00	1.50	1.50	-	2.1	7.0	9.8	930	2200	2540	8.41	7.0	6.60	A++	3.78
	10	07	05	05	-	2.50	2.00	1.50	1.50	-	2.2	7.5	10.1	930	2460	2730	8.99	7.5	6.70	A++	3.79
	13	07	05	05	-	3.50	2.00	1.50	1.50	-	2.3	8.5	11.0	930	2660	2810	10.10	8.5	6.90	A++	3.81
	16	07	05	05	-	4.60	2.00	1.50	1.50	-	2.5	9.6	11.5	930	2720	2840	11.30	9.6	7.20	A++	3.84
	18	07	05	05	-	5.00	2.00	1.50	1.50	-	2.5	10.0	11.5	930	2720	2850	11.75	10.0	7.20	A++	3.85
	22	07	05	05	-	5.50	1.80	1.35	1.35	-	2.5	10.0	11.5	930	2730	2880	11.75	10.0	7.20	A++	3.85
	24	07	05	05	-	5.83	1.67	1.25	1.25	-	2.5	10.0	11.5	930	2730	2880	11.75	10.0	7.20	A++	3.85
	10	10	05	05	-	2.50	2.50	1.50	1.50	-	2.3	8.0	10.4	930	2660	2810	9.52	8.0	6.80	A++	3.81
	13	10	05	05	-	3.50	2.50	1.50	1.50	-	2.4	9.0	11.3	930	2720	2840	10.63	9.0	7.10	A++	3.83
	16	10	05	05	-	4.55	2.48	1.49	1.49	-	2.5	10.0	11.5	930	2720	2850	11.75	10.0	7.30	A++	3.85
	18	10	05	05	-	4.76	2.38	1.43	1.43	-	2.5	10.0	11.5	930	2730	2870	11.75	10.0	7.20	A++	3.85
	22	10	05	05	-	5.26	2.16	1.29	1.29	-	2.5	10.0	11.5	930	2730	2880	11.75	10.0	7.20	A++	3.85
	24	10	05	05	-	5.60	2.00	1.20	1.20	-	2.5	10.0	11.5	930	2740	2900	11.75	10.0	7.20	A++	3.85
	13	13	05	05	-	3.50	3.50	1.50	1.50	-	2.5	10.0	11.5	930	2720	2850	11.75	10.0	7.30	A++	3.85
	16	13	05	05	-	4.14	3.15	1.35	1.35	-	2.5	10.0	11.5	930	2730	2880	11.75	10.0	7.30	A++	3.85
	18	13	05	05	-	4.35	3.04	1.30	1.30	-	2.5	10.0	11.5	930	2730	2880	11.75	10.0	7.20	A++	3.85
	22	13	05	05	-	4.84	2.78	1.19	1.19	-	2.5	10.0	11.5	930	2740	2900	11.75	10.0	7.20	A++	3.85
	24	13	05	05	-	5.19	2.59	1.11	1.11	-	2.5	10.0	11.5	930	2740	2900	11.75	10.0	7.20	A++	3.85
	16	16	05	05	-	3.77	3.77	1.23	1.23	-	2.5	10.0	11.5	930	2730	2880	11.75	10.0	7.30	A++	3.85
	18	16	05	05	-	3.97	3.65	1.19	1.19	-	2.5	10.0	11.5	930	2740	2900	11.75	10.0	7.20	A++	3.85
	22	16	05	05	-	4.45	3.36	1.09	1.09	-	2.5	10.0	11.5	930	2740	2900	11.75	10.0	7.20	A++	3.85
	24	16	05	05	-	4.79	3.15	1.03	1.03	-	2.5	10.0	11.5	930	2740	2900	11.75	10.0	7.20	A++	3.85
	18	18	05	05	-	3.85	3.85	1.15	1.15	-	2.5	10.0	11.5	930	2740	2900	11.75	10.0	7.20	A++	3.85
	22	18	05	05	-	4.33	3.55	1.06	1.06	-	2.5	10.0	11.5	930	2740	2900	11.75	10.0	7.20	A++	3.85
	24	18	05	05	-	4.67	3.33	1.00	1.00	-	2.5	10.0	11.5	930	2740	2900	11.75	10.0	7.20	A++	3.85
	22	22	05	05	-	4.01	4.01	0.99	0.99	-	2.5	10.0	11.5	930	2740	2900	11.75	10.0	7.20	A++	3.85
	07	07	07	05	-	2.00	2.00	2.00	1.50	-	2.2	7.5	10.7	930	2370	2670	8.99	7.5	6.70	A++	3.79
	10	07	07	05	-	2.50	2.00	2.00	1.50	-	2.3	8.0	11.0	930	2600	2810	9.52	8.0	6.80	A++	3.81
	13	07	07	05	-	3.50	2.00	2.00	1.50	-	2.4	9.0	11.5	930	2710	2830	10.63	9.0	7.10	A++	3.83
	16	07	07	05	-	4.55	1.98	1.98	1.49	-	2.5	10.0	11.5	930	2720	2850	11.75	10.0	7.30	A++	3.85
	18	07	07	05	-	4.76	1.90	1.90	1.43	-	2.5	10.0	11.5	930	2720	2850	11.75	10.0	7.20	A++	3.85
	22	07	07	05	-	5.26	1.72	1.72	1.29	-	2.5	10.0	11.5	930	2730	2880	11.75	10.0	7.20	A++	3.85
	24	07	07	05	-	5.60	1.60	1.60	1.20	-	2.5	10.0	11.5	930	2740	2900	11.75	10.0	7.20	A++	3.85
	10	10	07	05	-	2.50	2.50	2.00	1.50	-	2.3	8.5	11.3	930	2710	2830	10.10	8.5	6.90	A++	3.81
	13	10	07	05	-	3.50	2.50	2.00	1.50	-	2.4	9.5	11.5	930	2720	2850	11.21	9.5	7.20	A++	3.83
	16	10	07	05	-	4.34	2.36	1.89	1.42	-	2.5	10.0	11.5	930	2730	2870	11.75	10.0	7.30	A++	3.85
	18	10	07	05	-	4.55	2.27	1.82	1.36	-	2.5	10.0	11.5	930	2730	2880	11.75	10.0	7.20	A++	3.85
	22	10	07	05	-	5.04	2.07	1.65	1.24	-	2.5	10.0	11.5	930	2740	2900	11.75	10.0	7.20	A++	3.85
	24	10	07	05	-	5.38	1.92	1.54	1.15	-	2.5	10.0	11.5	930	2740	2900	11.75	10.0	7.20	A++	3.85
	13	13	07	05	-	3.33	3.33	1.90	1.43	-	2.5	10.0	11.5	930	2730	2870	11.75	10.0	7.30	A++	3.85
16	13	07	05	-	3.97	3.02	1.72	1.29	-	2.5	10.0	11.5	930	2730	2880	11.75	10.0	7.30	A++	3.85	
18	13	07	05	-	4.17	2.92	1.67	1.25	-	2.5	10.0	11.5	930	2740	2900	11.75	10.0	7.20	A++	3.85	
22	13	07	05	-	4.66	2.67	1.53	1.15	-	2.5	10.0	11.5	930	2740	2900	11.75	10.0	7.20	A++	3.85	
24	13	07	05	-	5.00	2.50	1.43	1.07	-	2.5	10.0	11.5	930	2740	2900	11.75	10.0	7.20	A++	3.85	
16	16	07	05	-	3.62	3.62	1.57	1.18	-	2.5	10.0	11.5	930	2740	2900	11.75	10.0	7.30	A++	3.85	
18	16	07	05	-	3.82	3.51	1.53	1.15	-	2.5	10.0	11.5	930	2740	2900	11.75	10.0	7.20	A++	3.85	
22	16	07	05	-	4.30	3.24	1.41	1.06	-	2.5	10.0	11.5	930	2740	2900	11.75	10.0	7.20	A++	3.85	
18	18	07	05	-	3.70	3.70	1.48	1.11	-	2.5	10.0	11.5	930	2740	2900	11.75	10.0	7.20	A++	3.85	
22	18	07	05	-	4.18	3.42	1.37	1.03	-	2.5	10.0	11.5	930	2740	2900	11.75	10.0	7.20	A++	3.85	
10	10	10	05	-	2.50	2.50	2.50	1.50	-	2.4	9.0	11.5	930	2720	2850	10.63	9.0	7.10	A++	3.83	
13	10	10	05	-	3.50	2.50	2.50	1.50	-	2.5	10.0	11.5	930	2730	2870	11.75	10.0	7.30	A++	3.85	
16	10	10	05	-	4.14	2.25	2.25	1.35	-	2.5	10.0	11.5	930	2730	2880	11.75	10.0	7.30	A++	3.85	
18	10	10	05	-	4.35	2.17	2.17	1.30	-	2.5	10.0	11.5	930	2740	2900	11.75	10.0	7.20	A++	3.85	
22	10	10	05	-	4.84	1.98	1.98	1.1													



RAS-5M34G3AVG-E / TR - Performances in Cooling mode

Operating status	Combination					Unit capacity (kW)					Cooling capacity (kW)			Power input (W)			Operating current (A)		Lot.10 SEER	Class	EER Nom.
	Unit A	Unit B	Unit C	Unit D	Unit E	Unit A	Unit B	Unit C	Unit D	Unit E	Min.	Nom.	Max.	Min.	Nom.	Max.	Nom.	Pdc			
4 units operations	24	16	07	07	-	4.49	2.95	1.28	1.28	-	2.5	10.0	11.5	950	2740	2900	11.75	10.0	7.20	+++	3.85
	18	18	07	07	-	3.57	3.57	1.43	1.43	-	2.5	10.0	11.5	950	2740	2900	11.75	10.0	7.20	+++	3.85
	22	18	07	07	-	4.04	3.31	1.32	1.32	-	2.5	10.0	11.5	950	2740	2900	11.75	10.0	7.20	+++	3.85
	24	18	07	07	-	4.38	3.13	1.25	1.25	-	2.5	10.0	11.5	950	2740	2900	11.75	10.0	7.20	+++	3.85
	10	10	10	07	-	2.50	2.50	2.60	2.00	-	2.4	9.5	11.5	940	2720	2850	11.21	9.5	7.20	+++	3.83
	13	10	10	07	-	3.33	2.38	2.38	1.90	-	2.5	10.0	11.5	940	2730	2880	11.75	10.0	7.30	+++	3.85
	16	10	10	07	-	3.97	2.16	2.16	1.72	-	2.5	10.0	11.5	940	2730	2880	11.75	10.0	7.30	+++	3.85
	18	10	10	07	-	4.17	2.08	2.08	1.67	-	2.5	10.0	11.5	950	2740	2900	11.75	10.0	7.20	+++	3.85
	22	10	10	07	-	4.66	1.91	1.91	1.53	-	2.5	10.0	11.5	950	2740	2900	11.75	10.0	7.20	+++	3.85
	24	10	10	07	-	5.00	1.79	1.79	1.43	-	2.5	10.0	11.5	950	2740	2900	11.75	10.0	7.20	+++	3.85
	13	13	10	07	-	3.04	3.04	2.17	1.74	-	2.5	10.0	11.5	950	2740	2900	11.75	10.0	7.30	+++	3.85
	16	13	10	07	-	3.65	2.78	1.98	1.59	-	2.5	10.0	11.5	950	2740	2900	11.75	10.0	7.30	+++	3.85
	18	13	10	07	-	3.85	2.69	1.92	1.54	-	2.5	10.0	11.5	950	2740	2900	11.75	10.0	7.20	+++	3.85
	22	13	10	07	-	4.33	2.48	1.77	1.42	-	2.5	10.0	11.5	950	2740	2900	11.75	10.0	7.20	+++	3.85
	24	13	10	07	-	4.67	2.33	1.67	1.33	-	2.5	10.0	11.5	950	2740	2900	11.75	10.0	7.20	+++	3.85
	16	16	10	07	-	3.36	3.36	1.82	1.46	-	2.5	10.0	11.5	950	2740	2900	11.75	10.0	7.30	+++	3.85
	18	16	10	07	-	3.55	3.26	1.77	1.42	-	2.5	10.0	11.5	950	2740	2900	11.75	10.0	7.20	+++	3.85
	22	16	10	07	-	4.01	3.03	1.64	1.32	-	2.5	10.0	11.5	950	2740	2900	11.75	10.0	7.20	+++	3.85
	24	16	10	07	-	4.35	2.86	1.55	1.24	-	2.5	10.0	11.5	950	2740	2900	11.75	10.0	7.20	+++	3.85
	18	18	10	07	-	3.45	3.45	1.72	1.38	-	2.5	10.0	11.5	950	2740	2900	11.75	10.0	7.20	+++	3.85
	22	18	10	07	-	3.91	3.21	1.60	1.28	-	2.5	10.0	11.5	950	2740	2900	11.75	10.0	7.20	+++	3.85
	24	18	10	07	-	4.24	3.03	1.52	1.21	-	2.5	10.0	11.5	950	2740	2900	11.75	10.0	7.20	+++	3.85
	13	13	13	07	-	2.80	2.80	2.80	1.60	-	2.5	10.0	11.5	950	2740	2900	11.75	10.0	7.30	+++	3.85
	16	13	13	07	-	3.38	2.57	2.57	1.47	-	2.5	10.0	11.5	950	2740	2900	11.75	10.0	7.30	+++	3.85
	18	13	13	07	-	3.57	2.50	2.50	1.43	-	2.5	10.0	11.5	950	2740	2900	11.75	10.0	7.20	+++	3.85
	22	13	13	07	-	4.04	2.32	2.32	1.32	-	2.5	10.0	11.5	950	2740	2900	11.75	10.0	7.20	+++	3.85
	24	13	13	07	-	4.38	2.19	2.19	1.25	-	2.5	10.0	11.5	950	2740	2900	11.75	10.0	7.20	+++	3.85
	16	16	13	07	-	3.13	3.13	2.38	1.36	-	2.5	10.0	11.5	950	2740	2900	11.75	10.0	7.30	+++	3.85
	18	16	13	07	-	3.31	3.05	2.32	1.32	-	2.5	10.0	11.5	950	2740	2900	11.75	10.0	7.20	+++	3.85
	22	16	13	07	-	3.77	2.84	2.16	1.23	-	2.5	10.0	11.5	950	2740	2900	11.75	10.0	7.20	+++	3.85
	24	16	13	07	-	4.09	2.69	2.05	1.17	-	2.5	10.0	11.5	950	2740	2900	11.75	10.0	7.20	+++	3.85
	18	18	13	07	-	3.23	3.23	2.26	1.29	-	2.5	10.0	11.5	950	2740	2900	11.75	10.0	7.20	+++	3.85
	22	18	13	07	-	3.67	3.01	2.11	1.20	-	2.5	10.0	11.5	950	2740	2900	11.75	10.0	7.20	+++	3.85
	24	18	13	07	-	4.00	2.86	2.00	1.14	-	2.5	10.0	11.5	950	2740	2900	11.75	10.0	7.20	+++	3.85
	10	10	10	10	-	2.50	2.50	2.50	2.50	-	2.5	10.0	11.5	940	2720	2850	11.75	10.0	7.30	+++	3.85
	13	10	10	10	-	3.18	2.27	2.27	2.27	-	2.5	10.0	11.5	940	2730	2880	11.75	10.0	7.30	+++	3.85
	16	10	10	10	-	3.80	2.07	2.07	2.07	-	2.5	10.0	11.5	950	2740	2900	11.75	10.0	7.30	+++	3.85
	18	10	10	10	-	4.00	2.00	2.00	2.00	-	2.5	10.0	11.5	950	2740	2900	11.75	10.0	7.20	+++	3.85
	22	10	10	10	-	4.49	1.84	1.84	1.84	-	2.5	10.0	11.5	950	2740	2900	11.75	10.0	7.20	+++	3.85
	24	10	10	10	-	4.83	1.72	1.72	1.72	-	2.5	10.0	11.5	950	2740	2900	11.75	10.0	7.20	+++	3.85
	13	13	10	10	-	2.92	2.92	2.08	2.08	-	2.5	10.0	11.5	950	2740	2900	11.75	10.0	7.30	+++	3.85
	16	13	10	10	-	3.51	2.67	1.91	1.91	-	2.5	10.0	11.5	950	2740	2900	11.75	10.0	7.30	+++	3.85
	18	13	10	10	-	3.70	2.59	1.85	1.85	-	2.5	10.0	11.5	950	2740	2900	11.75	10.0	7.20	+++	3.85
	22	13	10	10	-	4.18	2.40	1.71	1.71	-	2.5	10.0	11.5	950	2740	2900	11.75	10.0	7.20	+++	3.85
	24	13	10	10	-	4.52	2.26	1.61	1.61	-	2.5	10.0	11.5	950	2740	2900	11.75	10.0	7.20	+++	3.85
	16	16	10	10	-	3.24	3.24	1.76	1.76	-	2.5	10.0	11.5	950	2740	2900	11.75	10.0	7.30	+++	3.85
	18	16	10	10	-	3.42	3.15	1.71	1.71	-	2.5	10.0	11.5	950	2740	2900	11.75	10.0	7.20	+++	3.85
	22	16	10	10	-	3.89	2.93	1.59	1.59	-	2.5	10.0	11.5	950	2740	2900	11.75	10.0	7.20	+++	3.85
24	16	10	10	-	4.22	2.77	1.51	1.51	-	2.5	10.0	11.5	950	2740	2900	11.75	10.0	7.20	+++	3.85	
18	18	10	10	-	3.33	3.33	1.67	1.67	-	2.5	10.0	11.5	950	2740	2900	11.75	10.0	7.20	+++	3.85	
22	18	10	10	-	3.79	3.11	1.55	1.55	-	2.5	10.0	11.5	950	2740	2900	11.75	10.0	7.20	+++	3.85	
24	18	10	10	-	4.12	2.94	1.47	1.47	-	2.5	10.0	11.5	950	2740	2900	11.75	10.0	7.20	+++	3.85	
13	13	13	10	-	2.69	2.69	2.69	1.92	-	2.5	10.0	11.5	950	2740	2900	11.75	10.0	7.30	+++	3.85	
16	13	13	10	-	3.26	2.48	2.48	1.77	-	2.5	10.0	11.5	950	2740	2900	11.75	10.0	7.30	+++	3.85	
18	13	13	10	-	3.45	2.41	2.41	1.72	-	2.5	10.0	11.5	950	2740	2900	11.75	10.0	7.20	+++	3.85	
22	13	13	10	-	3.91	2.24	2.24	1.60	-	2.5	10.0	11.5	950	2740	2900	11.75	10.0	7.20	+++	3.85	
24	13	13	10	-	4.24	2.12	2.12	1.52	-	2.5	10.0	11.5	950	2740	2900	11.75	10.0	7.20	+++	3.85	
16	16	13	10	-	3.03	3.03	2.30	1.64	-	2.5	10.0	11.5	950	2740	2900	11.75	10.0	7.30	+++	3.85	
18	16	13	10	-	3.21	2.95	2.24	1.60	-	2.5	10.0	11.5	950	2740	2900	11.75	10.0	7.20	+++	3.85	
22	16	13	10	-	3.65	2.75	2.10	1.50	-	2.5	10.0	11.5	950	2740	2900	11.75	10.0	7.20	+++	3.85	
24	16	13	10	-	3.98	2.61	1.99	1.42	-	2.5	10.0	11.5	950	2740	2900	11.75	10.0	7.20	+++	3.85	
18	18	13	10	-	3.13	3.13	2.19	1.56	-	2.5	10.0	11.5	950	2740	2900	11.75	10.0	7.20	+++	3.85	
22	18	13	10	-	3.57	2.92	2.05	1.46	-	2.5	10.0	11.5	950	2740	2900	11.75	10.0	7.20	+++	3.85	
24	18	13	10	-	3.89	2.78	1.94	1.39	-	2.5	10.0	11.5	950	2740	2900	11.75	10.0	7.20	+++	3.85	
13	13	13	13	-	2.50	2.50	2.50	2.50	-	2.5	10.0	11.5	950	2740	2900	11.75	10.0	7.30	+++	3.85	
16	13	13	13	-	3.05	2.32	2.32	2.32	-	2.5	10.0	11.5	950	2740	2900	11.75	10.0	7.30	+++	3.85	
18	13	13	13	-	3.23	2.26	2.26	2.26	-	2.5	10.0	11.5	950	2740	2900	11.75	10.0	7.20	+++	3.85	
22	13	13	13	-	3.67	2.11	2.11	2.11	-	2.5	10.0	11.5	950	2740	2900	11.75	10.0	7.20	+++	3.85	
24	13	13	13	-	4.00	2.00	2.00	2.00	-	2.5	10.0	11.5	950	2740	2900	11.75					



**RAS-5M34G3AVG-E / TR - Performances in Cooling mode**

Operating status	Combination					Unit capacity (kW)					Cooling capacity (kW)			Power input (W)			Operating current (A)		Loi.10 SEER	Class	EER Nom.
	Unit A	Unit B	Unit C	Unit D	Unit E	Unit A	Unit B	Unit C	Unit D	Unit E	Min.	Nom.	Max.	Min.	Nom.	Max.	Nom.	Pdc			
Cooling, 230 V  5 units operations	13	07	07	05	05	3.33	1.90	1.90	1.43	1.43	2.5	10.0	11.5	950	2946	3670	11.75	10.0	7.20	A++	3.85
	16	07	07	05	05	3.97	1.72	1.72	1.29	1.29	2.5	10.0	11.5	950	2946	3670	11.75	10.0	7.20	A++	3.85
	18	07	07	05	05	4.17	1.67	1.67	1.25	1.25	2.5	10.0	11.5	950	2946	3670	11.75	10.0	7.20	A++	3.85
	10	10	07	05	05	2.50	2.50	2.00	1.50	1.50	2.5	10.0	11.5	950	2946	2800	11.75	10.0	7.20	A++	3.85
	13	10	07	05	05	3.18	2.27	1.82	1.36	1.36	2.5	10.0	11.5	950	2946	3670	11.75	10.0	7.20	A++	3.85
	16	10	07	05	05	3.80	2.07	1.65	1.24	1.24	2.5	10.0	11.5	950	2946	3670	11.75	10.0	7.20	A++	3.85
	18	10	07	05	05	4.00	2.00	1.60	1.20	1.20	2.5	10.0	11.5	950	2946	3670	11.75	10.0	7.20	A++	3.85
	13	13	07	05	05	2.92	2.92	1.67	1.25	1.25	2.5	10.0	11.5	950	2946	3670	11.75	10.0	7.20	A++	3.85
	16	13	07	05	05	3.51	2.67	1.53	1.15	1.15	2.5	10.0	11.5	950	2946	3670	11.75	10.0	7.20	A++	3.85
	18	13	07	05	05	3.70	2.59	1.48	1.11	1.11	2.5	10.0	11.5	950	2946	3670	11.75	10.0	7.20	A++	3.85
	16	16	07	05	05	3.24	3.24	1.41	1.06	1.06	2.5	10.0	11.5	950	2946	3670	11.75	10.0	7.20	A++	3.85
	18	16	07	05	05	3.42	3.15	1.37	1.03	1.03	2.5	10.0	11.5	950	2946	3670	11.75	10.0	7.20	A++	3.85
	10	10	10	05	05	2.38	2.38	2.38	1.43	1.43	2.5	10.0	11.5	950	2946	3670	11.75	10.0	7.20	A++	3.85
	13	10	10	05	05	3.04	2.17	2.17	1.30	1.30	2.5	10.0	11.5	950	2946	3670	11.75	10.0	7.20	A++	3.85
	16	10	10	05	05	3.65	1.98	1.98	1.19	1.19	2.5	10.0	11.5	950	2946	3670	11.75	10.0	7.20	A++	3.85
	18	10	10	05	05	3.85	1.92	1.92	1.15	1.15	2.5	10.0	11.5	950	2946	3670	11.75	10.0	7.20	A++	3.85
	13	13	10	05	05	2.80	2.80	2.00	1.20	1.20	2.5	10.0	11.5	950	2946	3670	11.75	10.0	7.20	A++	3.85
	07	07	07	07	05	2.00	2.00	2.00	1.50	2.4	9.5	11.5	950	2800	3300	11.21	9.5	7.10	A++	3.83	
	10	07	07	07	05	2.50	2.00	2.00	1.50	1.50	2.5	10.0	11.5	950	2946	3670	11.75	10.0	7.20	A++	3.85
	13	07	07	07	05	3.18	1.82	1.82	1.36	1.36	2.5	10.0	11.5	950	2946	3670	11.75	10.0	7.20	A++	3.85
	16	07	07	07	05	3.80	1.65	1.65	1.24	1.24	2.5	10.0	11.5	950	2946	3670	11.75	10.0	7.20	A++	3.85
	18	07	07	07	05	4.00	1.60	1.60	1.20	1.20	2.5	10.0	11.5	950	2946	3670	11.75	10.0	7.20	A++	3.85
	10	10	07	07	05	2.38	2.38	1.90	1.43	1.43	2.5	10.0	11.5	950	2946	3670	11.75	10.0	7.20	A++	3.85
	13	10	07	07	05	3.04	2.17	1.74	1.30	1.30	2.5	10.0	11.5	950	2946	3670	11.75	10.0	7.20	A++	3.85
	16	10	07	07	05	3.65	1.98	1.59	1.19	1.19	2.5	10.0	11.5	950	2946	3670	11.75	10.0	7.20	A++	3.85
	18	10	07	07	05	3.85	1.92	1.54	1.15	1.15	2.5	10.0	11.5	950	2946	3670	11.75	10.0	7.20	A++	3.85
	13	13	07	07	05	2.80	2.80	1.60	1.20	1.20	2.5	10.0	11.5	950	2946	3670	11.75	10.0	7.20	A++	3.85
	16	13	07	07	05	3.38	2.57	1.47	1.10	1.10	2.5	10.0	11.5	950	2946	3670	11.75	10.0	7.20	A++	3.85
	10	10	10	07	05	2.27	2.27	2.27	1.82	1.36	2.5	10.0	11.5	950	2946	3670	11.75	10.0	7.20	A++	3.85
	13	10	10	07	05	2.92	2.08	2.08	1.67	1.25	2.5	10.0	11.5	950	2946	3670	11.75	10.0	7.20	A++	3.85
	16	10	10	07	05	3.51	1.91	1.91	1.53	1.15	2.5	10.0	11.5	950	2946	3670	11.75	10.0	7.20	A++	3.85
	10	10	10	10	05	2.17	2.17	2.17	1.30	2.5	10.0	11.5	950	2946	3670	11.75	10.0	7.20	A++	3.85	
	07	07	07	07	07	2.00	2.00	2.00	2.00	2.00	2.5	10.0	11.5	950	2917	3630	11.75	10.0	7.20	A++	3.85
	10	07	07	07	07	2.38	1.90	1.90	1.43	1.43	2.5	10.0	11.5	950	2946	3670	11.75	10.0	7.20	A++	3.85
	13	07	07	07	07	3.04	1.74	1.74	1.30	1.30	2.5	10.0	11.5	950	2946	3670	11.75	10.0	7.20	A++	3.85
	16	07	07	07	07	3.65	1.59	1.59	1.19	1.19	2.5	10.0	11.5	950	2946	3670	11.75	10.0	7.20	A++	3.85
	18	07	07	07	07	3.85	1.54	1.54	1.15	1.15	2.5	10.0	11.5	950	2946	3670	11.75	10.0	7.20	A++	3.85
	10	10	07	07	07	2.27	2.27	1.82	1.36	1.36	2.5	10.0	11.5	950	2946	3670	11.75	10.0	7.20	A++	3.85
	13	10	07	07	07	2.92	2.08	1.67	1.25	1.25	2.5	10.0	11.5	950	2946	3670	11.75	10.0	7.20	A++	3.85
	16	10	07	07	07	3.51	1.91	1.53	1.15	1.15	2.5	10.0	11.5	950	2946	3670	11.75	10.0	7.20	A++	3.85
	18	10	07	07	07	3.70	1.85	1.48	1.15	1.15	2.5	10.0	11.5	950	2946	3670	11.75	10.0	7.20	A++	3.85
	13	13	07	07	07	2.69	2.69	1.54	1.15	1.15	2.5	10.0	11.5	950	2946	3670	11.75	10.0	7.20	A++	3.85
	16	13	07	07	07	3.26	2.48	1.42	1.10	1.10	2.5	10.0	11.5	950	2946	3670	11.75	10.0	7.20	A++	3.85
	18	13	07	07	07	3.45	2.41	1.38	1.10	1.10	2.5	10.0	11.5	950	2946	3670	11.75	10.0	7.20	A++	3.85
	16	16	07	07	07	3.03	3.03	1.32	1.10	1.10	2.5	10.0	11.5	950	2946	3670	11.75	10.0	7.20	A++	3.85
	18	16	07	07	07	3.21	2.95	1.28	1.10	1.10	2.5	10.0	11.5	950	2946	3670	11.75	10.0	7.20	A++	3.85
	10	10	10	07	07	2.17	2.17	1.74	1.30	1.30	2.5	10.0	11.5	950	2946	3670	11.75	10.0	7.20	A++	3.85
	13	10	10	07	07	2.80	2.00	2.00	1.60	1.60	2.5	10.0	11.5	950	2946	3670	11.75	10.0	7.20	A++	3.85
	16	10	10	07	07	3.38	1.84	1.84	1.47	1.47	2.5	10.0	11.5	950	2946	3670	11.75	10.0	7.20	A++	3.85
	18	10	10	07	07	3.57	1.79	1.79	1.43	1.43	2.5	10.0	11.5	950	2946	3670	11.75	10.0	7.20	A++	3.85
13	13	10	07	07	2.59	2.59	1.85	1.48	1.48	2.5	10.0	11.5	950	2946	3670	11.75	10.0	7.20	A++	3.85	
16	13	10	07	07	3.15	2.40	1.71	1.37	1.37	2.5	10.0	11.5	950	2946	3670	11.75	10.0	7.20	A++	3.85	
18	13	10	07	07	3.33	2.33	1.67	1.33	1.33	2.5	10.0	11.5	950	2946	3670	11.75	10.0	7.20	A++	3.85	
16	16	10	07	07	2.93	2.93	1.59	1.27	1.27	2.5	10.0	11.5	950	2946	3670	11.75	10.0	7.20	A++	3.85	
18	16	10	07	07	3.11	2.86	1.55	1.24	1.24	2.5	10.0	11.5	950	2946	3670	11.75	10.0	7.20	A++	3.85	
13	13	13	07	07	2.41	2.41	2.41	1.38	1.38	2.5	10.0	11.5	950	2946	3670	11.75	10.0	7.20	A++	3.85	
16	13	13	07	07	2.95	2.24	2.24	1.28	1.28	2.5	10.0	11.5	950	2946	3670	11.75	10.0	7.20	A++	3.85	
18	13	13	07	07	3.13	2.19	2.19	1.25	1.25	2.5	10.0	11.5	950	2946	3670	11.75	10.0	7.20	A++	3.85	
16	16	13	07	07	2.75	2.75	2.10	1.20	1.20	2.5	10.0	11.5	950	2946	3670	11.75	10.0	7.20	A++	3.85	
18	16	13	07	07	2.92	2.69	2.05	1.17	1.17	2.5	10.0	11.5	950	2946	3670	11.75	10.0	7.20	A++	3.85	
10	10	10	10	07	2.08	2.08	2.08	2.08	1.67	2.5	10.0	11.5	950	2946	3670	11.75	10.0	7.20	A++	3.85	
13	10	10	10	07	2.69	1.92	1.92	1.54	1.54	2.5	10.0	11.5	950	2946	3670	11.75	10.0	7.20	A++	3.85	
16	10	10	10	07	3.26	1.77	1.77	1.42	1.42	2.5	10.0	11.5	950	2946	3670	11.75	10.0	7.20	A++	3.85	
18	10	10	10	07	3.45	1.72	1.72	1.38	1.38	2.5	10.0	11.5	950	2946	3670	11.75	10.0	7.20	A++	3.85	
13	13	10	10	07	2.50	2.50	1.79	1.43	1.43	2.5	10.0	11.5	950	2946	3670	11.75	10.0	7.20	A++	3.85	
16	13	10	10	07	3.05	2.32	1.66	1.32	1.32	2.5	10.0	11.5	950	2946	3670	11.75	10.0	7.20	A++	3.85	
18	13	10	10																		

**RAS-5M34G3AVG-E / TR - Performances in Cooling mode**

Operating status	Combination					Unit capacity (kW)					Cooling capacity (kW)			Power input (W)			Operating current (A)		Lot.10 SEER	Class	EER Nom.
	Unit A	Unit B	Unit C	Unit D	Unit E	Unit A	Unit B	Unit C	Unit D	Unit E	Min.	Nom.	Max.	Min.	Nom.	Max.	Nom.	Pdc			
Cooling, 230 V 5 units operations	24	10	05	05	05	5.00	1.79	1.07	1.07	1.07	2.5	10.0	11.5	950	2946	3670	11.75	10.0	7.20	+++	3.85
	22	13	05	05	05	4.33	2.48	1.06	1.06	1.06	2.5	10.0	11.5	950	2946	3670	11.75	10.0	7.20	+++	3.85
	24	13	05	05	05	4.67	2.33	1.00	1.00	1.00	2.5	10.0	11.5	950	2946	3670	11.75	10.0	7.20	+++	3.85
	22	07	07	05	05	4.66	1.53	1.53	1.15	1.15	2.5	10.0	11.5	950	2946	3670	11.75	10.0	7.20	+++	3.85
	24	07	07	05	05	5.00	1.43	1.43	1.07	1.07	2.5	10.0	11.5	950	2946	3670	11.75	10.0	7.20	+++	3.85
	22	10	07	05	05	4.49	1.84	1.47	1.10	1.10	2.5	10.0	11.5	950	2946	3670	11.75	10.0	7.20	+++	3.85
	24	10	07	05	05	4.83	1.72	1.38	1.03	1.03	2.5	10.0	11.5	950	2946	3670	11.75	10.0	7.20	+++	3.85
	22	13	07	05	05	4.18	2.40	1.37	1.03	1.03	2.5	10.0	11.5	950	2946	3670	11.75	10.0	7.20	+++	3.85
	24	13	07	05	05	4.52	2.26	1.29	0.97	0.97	2.5	10.0	11.5	950	2946	3670	11.75	10.0	7.20	+++	3.85
	22	10	10	05	05	4.33	1.77	1.77	1.06	1.06	2.5	10.0	11.5	950	2946	3670	11.75	10.0	7.20	+++	3.85
	24	10	10	05	05	4.67	1.67	1.67	1.00	1.00	2.5	10.0	11.5	950	2946	3670	11.75	10.0	7.20	+++	3.85
	22	13	10	05	05	4.04	2.32	1.66	0.99	0.99	2.5	10.0	11.5	950	2946	3670	11.75	10.0	7.20	+++	3.85
	24	13	10	05	05	4.38	2.19	1.56	0.94	0.94	2.5	10.0	11.5	950	2946	3670	11.75	10.0	7.20	+++	3.85
	22	13	13	05	05	3.79	2.17	2.17	0.93	0.93	2.5	10.0	11.5	950	2946	3670	11.75	10.0	7.20	+++	3.85
	24	13	13	05	05	4.12	2.06	2.06	0.88	0.88	2.5	10.0	11.5	950	2946	3670	11.75	10.0	7.20	+++	3.85
	22	07	07	07	05	4.49	1.47	1.47	1.47	1.10	2.5	10.0	11.5	950	2946	3670	11.75	10.0	7.20	+++	3.85
	24	07	07	07	05	4.83	1.38	1.38	1.38	1.03	2.5	10.0	11.5	950	2946	3670	11.75	10.0	7.20	+++	3.85
	22	10	07	07	05	4.33	1.77	1.42	1.42	1.06	2.5	10.0	11.5	950	2946	3670	11.75	10.0	7.20	+++	3.85
	24	10	07	07	05	4.67	1.67	1.33	1.33	1.00	2.5	10.0	11.5	950	2946	3670	11.75	10.0	7.20	+++	3.85
	22	13	07	07	05	4.04	2.32	1.32	1.32	0.99	2.5	10.0	11.5	950	2946	3670	11.75	10.0	7.20	+++	3.85
	24	13	07	07	05	4.38	2.19	1.25	1.25	0.94	2.5	10.0	11.5	950	2946	3670	11.75	10.0	7.20	+++	3.85
	22	10	10	07	05	4.18	1.71	1.71	1.37	1.03	2.5	10.0	11.5	950	2946	3670	11.75	10.0	7.20	+++	3.85
	24	10	10	07	05	4.52	1.61	1.61	1.29	0.97	2.5	10.0	11.5	950	2946	3670	11.75	10.0	7.20	+++	3.85
	22	13	10	07	05	3.91	2.24	1.60	1.28	0.96	2.5	10.0	11.5	950	2946	3670	11.75	10.0	7.20	+++	3.85
	24	13	10	07	05	4.24	2.12	1.52	1.21	0.91	2.5	10.0	11.5	950	2946	3670	11.75	10.0	7.20	+++	3.85
	22	13	13	07	05	3.67	2.11	2.11	1.20	0.90	2.5	10.0	11.5	950	2946	3670	11.75	10.0	7.20	+++	3.85
	24	13	13	07	05	4.00	2.00	2.00	1.14	0.86	2.5	10.0	11.5	950	2946	3670	11.75	10.0	7.20	+++	3.85
	22	10	10	10	05	4.04	1.66	1.66	1.66	0.99	2.5	10.0	11.5	950	2946	3670	11.75	10.0	7.20	+++	3.85
	24	10	10	10	05	4.38	1.56	1.56	1.56	0.94	2.5	10.0	11.5	950	2946	3670	11.75	10.0	7.20	+++	3.85
	22	13	10	10	05	3.79	2.17	1.55	1.55	0.93	2.5	10.0	11.5	950	2946	3670	11.75	10.0	7.20	+++	3.85
	24	13	10	10	05	4.12	2.06	1.47	1.47	0.88	2.5	10.0	11.5	950	2946	3670	11.75	10.0	7.20	+++	3.85
	22	13	13	10	05	3.57	2.05	2.05	1.46	0.88	2.5	10.0	11.5	950	2946	3670	11.75	10.0	7.20	+++	3.85
	24	13	13	10	05	3.89	1.94	1.94	1.39	0.83	2.5	10.0	11.5	950	2946	3670	11.75	10.0	7.20	+++	3.85
	22	13	13	13	05	3.37	1.93	1.93	1.93	0.83	2.5	10.0	11.5	950	2946	3670	11.75	10.0	7.20	+++	3.85
	22	07	07	07	07	4.33	1.42	1.42	1.42	1.42	2.5	10.0	11.5	950	2946	3700	11.75	10.0	7.20	+++	3.85
	24	07	07	07	07	4.67	1.33	1.33	1.33	1.33	2.5	10.0	11.5	950	2946	3700	11.75	10.0	7.20	+++	3.85
	22	10	07	07	07	4.18	1.71	1.37	1.37	1.37	2.5	10.0	11.5	950	2946	3700	11.75	10.0	7.20	+++	3.85
	24	10	07	07	07	4.52	1.61	1.29	1.29	1.29	2.5	10.0	11.5	950	2946	3700	11.75	10.0	7.20	+++	3.85
	22	13	07	07	07	3.91	2.24	1.28	1.28	1.28	2.5	10.0	11.5	950	2946	3700	11.75	10.0	7.20	+++	3.85
	24	13	07	07	07	4.24	2.12	1.21	1.21	1.21	2.5	10.0	11.5	950	2946	3700	11.75	10.0	7.20	+++	3.85
	22	10	10	07	07	4.04	1.66	1.66	1.32	1.32	2.5	10.0	11.5	950	2946	3700	11.75	10.0	7.20	+++	3.85
	24	10	10	07	07	4.38	1.56	1.56	1.25	1.25	2.5	10.0	11.5	950	2946	3700	11.75	10.0	7.20	+++	3.85
	22	13	10	07	07	3.79	2.17	1.55	1.24	1.24	2.5	10.0	11.5	950	2946	3700	11.75	10.0	7.20	+++	3.85
	24	13	10	07	07	4.12	2.06	1.47	1.18	1.18	2.5	10.0	11.5	950	2946	3700	11.75	10.0	7.20	+++	3.85
	22	13	13	07	07	3.57	2.05	2.05	1.17	1.17	2.5	10.0	11.5	950	2946	3700	11.75	10.0	7.20	+++	3.85
	24	13	13	07	07	3.89	1.94	1.94	1.11	1.11	2.5	10.0	11.5	950	2946	3700	11.75	10.0	7.20	+++	3.85
	22	10	10	10	07	3.91	1.60	1.60	1.60	1.28	2.5	10.0	11.5	950	2946	3700	11.75	10.0	7.20	+++	3.85
	24	10	10	10	07	4.24	1.52	1.52	1.52	1.21	2.5	10.0	11.5	950	2946	3700	11.75	10.0	7.20	+++	3.85
	22	13	10	10	07	3.67	2.11	1.51	1.51	1.20	2.5	10.0	11.5	950	2946	3700	11.75	10.0	7.20	+++	3.85
	24	13	10	10	07	4.00	2.00	1.43	1.43	1.14	2.5	10.0	11.5	950	2946	3700	11.75	10.0	7.20	+++	3.85
22	13	13	10	07	3.47	1.99	1.99	1.42	1.14	2.5	10.0	11.5	950	2980	3700	11.75	10.0	7.20	+++	3.85	
24	13	13	10	07	3.78	1.89	1.89	1.35	1.08	2.5	10.0	11.5	950	2980	3700	11.75	10.0	7.20	+++	3.85	
22	13	13	13	07	3.28	1.88	1.88	1.88	1.08	2.5	10.0	11.5	950	2980	3700	11.75	10.0	7.20	+++	3.85	
22	10	10	10	10	3.79	1.55	1.55	1.55	1.55	2.5	10.0	11.5	950	2946	3700	11.75	10.0	7.20	+++	3.85	
24	10	10	10	10	4.12	1.47	1.47	1.47	1.47	2.5	10.0	11.5	950	2946	3700	11.75	10.0	7.20	+++	3.85	
22	13	10	10	10	3.57	2.05	1.46	1.46	1.46	2.5	10.0	11.5	950	2980	3700	11.75	10.0	7.20	+++	3.85	
24	13	10	10	10	3.89	1.94	1.39	1.39	1.39	2.5	10.0	11.5	950	2980	3700	11.75	10.0	7.20	+++	3.85	
22	13	13	10	10	3.37	1.93	1.93	1.38	1.38	2.5	10.0	11.5	950	2980	3700	11.75	10.0	7.20	+++	3.85	

RESIDENTIAL AIR-TO-AIR

**RAS-5M34G3AVG-E / TR - Performances in Heating mode**

Operating status	Combination					Unit capacity (kW)					Heating capacity (kW)			Power input (W)			Operating current (A)		Lot.10 SCOP Warm climate	Label Average climate	Warm climate	COP Nom.
	Unit A	Unit B	Unit C	Unit D	Unit E	Unit A	Unit B	Unit C	Unit D	Unit E	Min.	Nom.	Max.	Min.	Nom.	Max.	Nom.	Pdc				
1 unit operation	05	-	-	-	-	2.00	-	-	-	-	1.3	2.0	2.5	390	650	800	-	-	-	-	-	
	07	-	-	-	-	2.50	-	-	-	-	1.4	2.5	3.6	390	760	1120	-	-	-	-	-	
	10	-	-	-	-	3.20	-	-	-	-	1.4	3.2	4.8	390	910	1450	-	-	-	-	-	
	13	-	-	-	-	4.20	-	-	-	-	1.5	4.2	5.3	390	1130	1590	-	-	-	-	-	
	16	-	-	-	-	5.50	-	-	-	-	1.6	5.5	6.5	390	1410	1930	-	-	-	-	-	
	18	-	-	-	-	6.00	-	-	-	-	1.7	6.0	6.5	390	1510	1930	-	-	-	-	-	
	22	-	-	-	-	7.00	-	-	-	-	1.8	7.0	7.5	390	1730	2220	-	-	-	-	-	
	24	-	-	-	-	8.00	-	-	-	-	1.8	8.0	8.8	390	1940	2580	-	-</				





**RAS-5M34G3AVG-E / TR - Performances in Heating mode**

Operating status	Combination					Unit capacity (kW)					Heating capacity (kW)			Power input (W)			Operating current (A)			Label			COP	
	Unit A	Unit B	Unit C	Unit D	Unit E	Unit A	Unit B	Unit C	Unit D	Unit E	Min.	Nom.	Max.	Min.	Nom.	Max.	Nom.	Pah	SCOP	SCOP Warm climate	Average climate	Warm climate		Nom.
2 units operations	24	13	-	-	-	7.87	4.13	-	-	-	2.2	12.0	14.1	430	2800	4080	12.66	6.8	4.30	5.40	A+	A+++	4.29	
	16	16	-	-	-	5.50	5.50	-	-	-	2.1	11.0	13.0	410	2590	3770	11.71	6.2	4.20	5.20	A+	A+++	4.25	
	18	16	-	-	-	6.00	5.50	-	-	-	2.2	11.5	13.0	430	2700	3770	12.20	6.5	4.20	5.30	A+	A+++	4.26	
	22	16	-	-	-	6.72	5.28	-	-	-	2.2	12.0	14.0	430	2800	4050	12.66	6.8	4.30	5.40	A+	A+++	4.29	
	24	16	-	-	-	7.11	4.89	-	-	-	2.2	12.0	14.2	430	2800	4100	12.66	6.8	4.30	5.40	A+	A+++	4.29	
	18	18	-	-	-	6.00	6.00	-	-	-	2.2	12.0	13.0	430	2800	3770	12.66	6.8	4.30	5.40	A+	A+++	4.29	
	22	18	-	-	-	6.46	5.54	-	-	-	2.2	12.0	14.0	440	2800	4050	12.66	6.8	4.30	5.40	A+	A+++	4.29	
	24	18	-	-	-	6.86	5.14	-	-	-	2.2	12.0	14.2	440	2800	4100	12.66	6.8	4.30	5.40	A+	A+++	4.29	
	22	22	-	-	-	6.00	6.00	-	-	-	2.2	12.0	14.2	440	2800	4100	12.66	6.8	4.30	5.40	A+	A+++	4.29	
	24	22	-	-	-	6.40	5.60	-	-	-	2.2	12.0	14.2	440	2800	4100	12.66	6.8	4.30	5.40	A+	A+++	4.29	
	24	24	-	-	-	6.00	6.00	-	-	-	2.2	12.0	14.2	460	2800	4100	12.66	6.8	4.30	5.40	A+	A+++	4.29	
	3 units operations	05	05	05	-	-	2.00	2.00	2.00	-	-	1.7	6.0	7.5	430	1510	2220	6.91	3.4	4.20	5.30	A+	A+++	3.97
		07	05	05	-	-	2.50	2.00	2.00	-	-	1.7	6.5	8.6	430	1620	2530	7.39	3.7	4.20	5.30	A+	A+++	4.01
		10	05	05	-	-	3.20	2.00	2.00	-	-	1.8	7.2	9.8	430	1770	2860	8.06	4.1	4.20	5.30	A+	A+++	4.07
		13	05	05	-	-	4.20	2.00	2.00	-	-	1.9	8.2	10.3	440	1990	3000	9.03	4.6	4.20	5.10	A+	A+++	4.12
		16	05	05	-	-	5.50	2.00	2.00	-	-	2.0	9.5	11.5	440	2270	3340	10.27	5.4	4.20	5.10	A+	A+++	4.19
18		05	05	-	-	6.00	2.00	2.00	-	-	2.0	10.0	11.5	440	2370	3340	10.72	5.7	4.20	5.10	A+	A+++	4.22	
22		05	05	-	-	7.00	2.00	2.00	-	-	2.1	11.0	12.5	460	2590	3630	11.71	6.2	4.20	5.10	A+	A+++	4.25	
24		05	05	-	-	8.00	2.00	2.00	-	-	2.2	12.0	13.8	460	2800	3990	12.66	6.8	4.30	5.30	A+	A+++	4.29	
07		07	05	-	-	2.50	2.50	2.00	-	-	1.8	7.0	9.7	430	1730	2840	7.88	4.0	4.20	5.30	A+	A+++	4.05	
10		07	05	-	-	3.20	2.50	2.00	-	-	1.8	7.7	10.9	430	1880	3170	8.54	4.4	4.20	5.10	A+	A+++	4.10	
13		07	05	-	-	4.20	2.50	2.00	-	-	1.9	8.7	11.4	440	2100	3320	9.52	4.9	4.20	5.10	A+	A+++	4.14	
16		07	05	-	-	5.50	2.50	2.00	-	-	2.0	10.0	12.6	440	2370	3650	10.72	5.7	4.20	5.10	A+	A+++	4.22	
18		07	05	-	-	6.00	2.50	2.00	-	-	2.1	10.5	12.6	460	2480	3650	11.21	6.0	4.20	5.10	A+	A+++	4.23	
22		07	05	-	-	7.00	2.50	2.00	-	-	2.2	11.5	13.6	460	2700	3940	12.20	6.5	4.20	5.20	A+	A+++	4.26	
24		07	05	-	-	7.68	2.40	1.92	-	-	2.2	12.0	14.2	460	2800	4100	12.66	6.8	4.30	5.30	A+	A+++	4.29	
10		10	05	-	-	3.20	3.20	2.00	-	-	1.9	8.4	12.1	430	2030	3510	9.21	4.8	4.20	5.10	A+	A+++	4.14	
13		10	05	-	-	4.20	3.20	2.00	-	-	2.0	9.4	12.6	440	2250	3650	10.18	5.3	4.20	5.10	A+	A+++	4.18	
16		10	05	-	-	5.50	3.20	2.00	-	-	2.1	10.7	13.8	440	2530	3990	11.44	6.1	4.20	5.10	A+	A+++	4.23	
18		10	05	-	-	6.00	3.20	2.00	-	-	2.1	11.2	13.8	460	2630	3990	11.89	6.3	4.20	5.20	A+	A+++	4.26	
22		10	05	-	-	6.89	3.15	1.97	-	-	2.2	12.0	14.2	460	2800	4100	12.66	6.8	4.30	5.30	A+	A+++	4.29	
24		10	05	-	-	7.27	2.91	1.82	-	-	2.2	12.0	14.2	460	2800	4100	12.66	6.8	4.30	5.30	A+	A+++	4.29	
13		13	05	-	-	4.20	4.20	2.00	-	-	2.1	10.4	13.1	440	2460	3790	11.12	5.9	4.20	5.10	A+	A+++	4.23	
16		13	05	-	-	5.50	4.20	2.00	-	-	2.2	11.7	14.2	440	2740	4100	12.38	6.6	4.20	5.30	A+	A+++	4.27	
18		13	05	-	-	5.90	4.13	1.97	-	-	2.2	12.0	14.2	460	2800	4100	12.66	6.8	4.30	5.30	A+	A+++	4.29	
22		13	05	-	-	6.36	3.82	1.82	-	-	2.2	12.0	14.2	460	2800	4100	12.66	6.8	4.30	5.30	A+	A+++	4.29	
24		13	05	-	-	6.76	3.55	1.69	-	-	2.2	12.0	14.2	460	2800	4100	12.66	6.8	4.30	5.30	A+	A+++	4.29	
16		16	05	-	-	5.08	5.08	1.85	-	-	2.2	12.0	14.2	440	2800	4100	12.66	6.8	4.30	5.30	A+	A+++	4.29	
18		16	05	-	-	5.33	4.89	1.78	-	-	2.2	12.0	14.2	460	2800	4100	12.66	6.8	4.30	5.30	A+	A+++	4.29	
22		16	05	-	-	5.79	4.55	1.66	-	-	2.2	12.0	14.2	460	2800	4100	12.66	6.8	4.30	5.30	A+	A+++	4.29	
24		16	05	-	-	6.19	4.26	1.55	-	-	2.2	12.0	14.2	480	2800	4100	12.66	6.8	4.30	5.30	A+	A+++	4.29	
18		18	05	-	-	5.14	5.14	1.71	-	-	2.2	12.0	14.2	480	2800	4100	12.66	6.8	4.30	5.30	A+	A+++	4.29	
22		18	05	-	-	5.60	4.80	1.60	-	-	2.2	12.0	14.2	480	2800	4100	12.66	6.8	4.30	5.30	A+	A+++	4.29	
24		18	05	-	-	6.00	4.50	1.50	-	-	2.2	12.0	14.2	490	2800	4100	12.66	6.8	4.30	5.30	A+	A+++	4.29	
22		22	05	-	-	5.25	5.25	1.50	-	-	2.2	12.0	14.2	490	2800	4100	12.66	6.8	4.30	5.30	A+	A+++	4.29	
24		22	05	-	-	5.65	4.94	1.41	-	-	2.2	12.0	14.2	490	2800	4100	12.66	6.8	4.30	5.30	A+	A+++	4.29	
24		24	05	-	-	5.33	5.33	1.33	-	-	2.2	12.0	14.2	490	2800	4100	12.66	6.8	4.30	5.30	A+	A+++	4.29	
07		07	07	-	-	2.50	2.50	2.50	-	-	1.8	7.5	10.8	440	1840	3150	8.37	4.3	4.20	5.30	A+	A+++	4.08	
10		07	07	-	-	3.20	2.50	2.50	-	-	1.9	8.2	12.0	440	1990	3480	9.03	4.6	4.20	5.10	A+	A+++	4.12	
13		07	07	-	-	4.20	2.50	2.50	-	-	2.0	9.2	12.5	440	2200	3630	9.96	5.2	4.20	5.10	A+	A+++	4.18	
16		07	07	-	-	5.50	2.50	2.50	-	-	2.1	10.5	13.7	440	2480	3960	11.21	6.0	4.20	5.10	A+	A+++	4.23	
18		07	07	-	-	6.00	2.50	2.50	-	-	2.1	11.0	13.7	460	2590	3960	11.71	6.2	4.20	5.10	A+	A+++	4.25	
22		07	07	-	-	7.00	2.50	2.50	-	-	2.2	12.0	14.2	460	2800	4100	12.66	6.8	4.30	5.30	A+	A+++	4.29	
24		07	07	-	-	7.38	2.31	2.31	-	-	2.2	12.0	14.2	460	2800	4100	12.66	6.8	4.30	5.30	A+	A+++	4.29	
10		10	07	-	-	3.20	3.20	2.50	-	-	1.9	8.9	13.2	440	2140	3820	9.70	5.0	4.20	5.10	A+	A+++	4.16	
13		10	07	-	-	4.20	3.20	2.50	-	-	2.0	9.9	13.7	440	2350	3960	10.63	5.6	4.20	5.10	A+	A+++	4.21	
16		10	07	-	-	5.50	3.20	2.50	-	-	2.1	11.2	14.2	440	2630	4100	11.89	6.3	4.20	5.20	A+	A+++	4.26	
18		10	07	-	-	6.00	3.20	2.50	-	-	2.2	11.7	14.2	460	2740	4100	12.38	6.6	4.20	5.30	A+	A+++	4.27	
22		10																						

RAS-5M34G3AVG-E / TR - Performances in Heating mode

Operating status	Combination					Unit capacity (kW)					Heating capacity (kW)			Power input (W)			Operating current (A)			Lot.10	Label	COP	
	Unit A	Unit B	Unit C	Unit D	Unit E	Unit A	Unit B	Unit C	Unit D	Unit E	Min.	Nom.	Max.	Min.	Nom.	Max.	Nom.	Pdh	SCOP				SCOP Warm climate
3 units operations	22	13	13	-	-	5.45	3.27	3.27	-	-	2.2	12.0	14.2	480	2800	4100	12.66	6.8	4.30	5.30	A+	A+++	4.29
	24	13	13	-	-	5.85	3.07	3.07	-	-	2.2	12.0	14.2	480	2800	4100	12.66	6.8	4.30	5.30	A+	A+++	4.29
	16	16	13	-	-	4.34	4.34	3.32	-	-	2.2	12.0	14.2	440	2800	4100	12.66	6.8	4.30	5.30	A+	A+++	4.29
	18	16	13	-	-	4.59	4.20	3.21	-	-	2.2	12.0	14.2	460	2800	4100	12.66	6.8	4.30	5.30	A+	A+++	4.29
	22	16	13	-	-	5.03	3.95	3.02	-	-	2.2	12.0	14.2	480	2800	4100	12.66	6.8	4.30	5.30	A+	A+++	4.29
	24	16	13	-	-	5.42	3.73	2.85	-	-	2.2	12.0	14.2	480	2800	4100	12.66	6.8	4.30	5.30	A+	A+++	4.29
	18	18	13	-	-	4.44	4.44	3.11	-	-	2.2	12.0	14.2	480	2800	4100	12.66	6.8	4.30	5.30	A+	A+++	4.29
	22	18	13	-	-	4.88	4.19	2.93	-	-	2.2	12.0	14.2	490	2800	4100	12.66	6.8	4.30	5.30	A+	A+++	4.29
	24	18	13	-	-	5.27	3.96	2.77	-	-	2.2	12.0	14.2	490	2800	4100	12.66	6.8	4.30	5.30	A+	A+++	4.29
	16	16	16	-	-	4.00	4.00	4.00	-	-	2.2	12.0	14.2	460	2800	4100	12.66	6.8	4.30	5.30	A+	A+++	4.29
	05	05	05	05	-	2.00	2.00	2.00	2.00	-	1.8	8.0	10.0	490	1940	2920	8.81	4.5	4.20	5.10	A+	A+++	4.12
	07	05	05	05	-	2.50	2.00	2.00	2.00	-	1.9	8.5	11.1	490	2050	3230	9.30	4.8	4.20	5.10	A+	A+++	4.15
	10	05	05	05	-	3.20	2.00	2.00	2.00	-	2.0	9.2	12.3	490	2200	3570	9.96	5.2	4.20	5.10	A+	A+++	4.18
	13	05	05	05	-	4.20	2.00	2.00	2.00	-	2.0	10.2	12.8	490	2420	3710	10.94	5.8	4.20	5.10	A+	A+++	4.21
	16	05	05	05	-	5.50	2.00	2.00	2.00	-	2.2	11.5	14.0	510	2700	4050	12.66	6.5	4.20	5.20	A+	A+++	4.26
	18	05	05	05	-	6.00	2.00	2.00	2.00	-	2.2	12.0	14.0	530	2800	4050	12.66	6.8	4.30	5.30	A+	A+++	4.29
22	05	05	05	-	6.46	1.85	1.85	1.85	-	2.2	12.0	14.2	530	2800	4100	12.66	6.8	4.30	5.30	A+	A+++	4.29	
24	05	05	05	-	6.86	1.71	1.71	1.71	-	2.2	12.0	14.2	540	2800	4100	12.66	6.8	4.30	5.30	A+	A+++	4.29	
07	07	05	05	-	2.50	2.50	2.00	2.00	-	1.9	9.0	12.2	490	2160	3540	9.78	5.1	4.20	5.10	A+	A+++	4.17	
10	07	05	05	-	3.20	2.50	2.00	2.00	-	2.0	9.7	13.4	490	2310	3880	10.45	5.5	4.20	5.10	A+	A+++	4.20	
13	07	05	05	-	4.20	2.50	2.00	2.00	-	2.1	10.7	13.9	510	2530	4020	11.44	6.1	4.20	5.10	A+	A+++	4.23	
16	07	05	05	-	5.50	2.50	2.00	2.00	-	2.2	12.0	14.2	510	2800	4100	12.66	6.8	4.30	5.30	A+	A+++	4.29	
18	07	05	05	-	5.76	2.40	1.92	1.92	-	2.2	12.0	14.2	530	2800	4100	12.66	6.8	4.30	5.30	A+	A+++	4.29	
22	07	05	05	-	6.22	2.22	1.78	1.78	-	2.2	12.0	14.2	540	2800	4100	12.66	6.8	4.30	5.30	A+	A+++	4.29	
24	07	05	05	-	6.62	2.07	1.66	1.66	-	2.2	12.0	14.2	540	2800	4100	12.66	6.8	4.30	5.30	A+	A+++	4.29	
10	10	05	05	-	3.20	3.20	2.00	2.00	-	2.1	10.4	14.2	490	2460	4100	11.12	5.9	4.20	5.10	A+	A+++	4.23	
13	10	05	05	-	4.20	3.20	2.00	2.00	-	2.2	11.4	14.2	510	2680	4100	12.11	6.5	4.20	5.20	A+	A+++	4.25	
16	10	05	05	-	5.20	3.02	1.89	1.89	-	2.2	12.0	14.2	510	2800	4100	12.66	6.8	4.30	5.30	A+	A+++	4.29	
18	10	05	05	-	5.45	2.91	1.82	1.82	-	2.2	12.0	14.2	530	2800	4100	12.66	6.8	4.30	5.30	A+	A+++	4.29	
22	10	05	05	-	5.92	2.70	1.69	1.69	-	2.2	12.0	14.2	540	2800	4100	12.66	6.8	4.30	5.30	A+	A+++	4.29	
24	10	05	05	-	6.32	2.53	1.58	1.58	-	2.2	12.0	14.2	540	2800	4100	12.66	6.8	4.30	5.30	A+	A+++	4.29	
13	13	05	05	-	4.06	4.06	1.94	1.94	-	2.2	12.0	14.2	510	2800	4100	12.66	6.8	4.30	5.30	A+	A+++	4.29	
16	13	05	05	-	4.82	3.68	1.75	1.75	-	2.2	12.0	14.2	510	2800	4100	12.66	6.8	4.30	5.30	A+	A+++	4.29	
18	13	05	05	-	5.07	3.55	1.69	1.69	-	2.2	12.0	14.2	540	2800	4100	12.66	6.8	4.30	5.30	A+	A+++	4.29	
22	13	05	05	-	5.53	3.32	1.58	1.58	-	2.2	12.0	14.2	540	2800	4100	12.66	6.8	4.30	5.30	A+	A+++	4.29	
24	13	05	05	-	5.93	3.11	1.48	1.48	-	2.2	12.0	14.2	540	2800	4100	12.66	6.8	4.30	5.30	A+	A+++	4.29	
16	16	05	05	-	4.40	4.40	1.60	1.60	-	2.2	12.0	14.2	510	2800	4100	12.66	6.8	4.30	5.30	A+	A+++	4.29	
18	16	05	05	-	4.65	4.26	1.55	1.55	-	2.2	12.0	14.2	540	2800	4100	12.66	6.8	4.30	5.30	A+	A+++	4.29	
22	16	05	05	-	5.09	4.00	1.45	1.45	-	2.2	12.0	14.2	540	2800	4100	12.66	6.8	4.30	5.30	A+	A+++	4.29	
24	16	05	05	-	5.49	3.77	1.37	1.37	-	2.2	12.0	14.2	540	2800	4100	12.66	6.8	4.30	5.30	A+	A+++	4.29	
18	18	05	05	-	4.50	4.50	1.50	1.50	-	2.2	12.0	14.2	540	2800	4100	12.66	6.8	4.30	5.30	A+	A+++	4.29	
22	18	05	05	-	4.94	4.24	1.41	1.41	-	2.2	12.0	14.2	540	2800	4100	12.66	6.8	4.30	5.30	A+	A+++	4.29	
24	18	05	05	-	5.33	4.00	1.33	1.33	-	2.2	12.0	14.2	540	2800	4100	12.66	6.8	4.30	5.30	A+	A+++	4.29	
22	22	05	05	-	4.67	4.67	1.33	1.33	-	2.2	12.0	14.2	540	2800	4100	12.66	6.8	4.30	5.30	A+	A+++	4.29	
07	07	07	05	-	2.50	2.50	2.50	2.00	-	2.0	9.5	13.3	510	2270	3850	10.27	5.4	4.20	5.10	A+	A+++	4.19	
10	07	07	05	-	3.20	2.50	2.50	2.00	-	2.0	10.2	14.2	510	2420	4100	10.94	5.8	4.20	5.10	A+	A+++	4.21	
13	07	07	05	-	4.20	2.50	2.50	2.00	-	2.1	11.2	14.2	510	2630	4100	11.89	6.3	4.20	5.10	A+	A+++	4.26	
16	07	07	05	-	5.28	2.40	2.40	1.92	-	2.2	12.0	14.2	510	2800	4100	12.66	6.8	4.30	5.30	A+	A+++	4.29	
18	07	07	05	-	5.54	2.31	2.31	1.85	-	2.2	12.0	14.2	530	2800	4100	12.66	6.8	4.30	5.30	A+	A+++	4.29	
22	07	07	05	-	6.00	2.14	2.14	1.71	-	2.2	12.0	14.2	540	2800	4100	12.66	6.8	4.30	5.30	A+	A+++	4.29	
24	07	07	05	-	6.40	2.00	2.00	1.60	-	2.2	12.0	14.2	540	2800	4100	12.66	6.8	4.30	5.30	A+	A+++	4.29	
10	10	07	05	-	3.20	3.20	2.50	2.00	-	2.1	10.9	14.2	510	2570	4100	11.62	6.2	4.20	5.10	A+	A+++	4.24	
13	10	07	05	-	4.20	3.20	2.50	2.00	-	2.2	11.9	14.2	510	2780	4100	12.57	6.7	4.30	5.30	A+	A+++	4.28	
16	10	07	05	-	5.00	2.91	2.27	1.82	-	2.2	12.0	14.2	510	2800	4100	12.66	6.8	4.30	5.30	A+	A+++	4.29	
18	10	07	05	-	5.26	2.80	2.19	1.75	-	2.2	12.0	14.2	530	2800	4100	12.66	6.8	4.30	5.30	A+	A+++	4.29	
22	10	07	05	-	5.71	2.61	2.04	1.63	-	2.2	12.0	14.2	540	2800	4100	12.66	6.8	4.30	5.30	A+	A+++	4.29	
24	10	07	05	-	6.11	2.45	1.91	1.53	-	2.2	12.0	14.2	540	2800	4100	12.66	6.8	4.30	5.30	A+	A+++	4.29	
13	13	07	05	-	3.91	3.91	2.33	1.86	-	2.2	12.0	14.2	510	2800	4100	12.66	6.8	4.30	5.30	A+	A+++	4.29	
16	13	07	05	-	4.65	3.55	2.11	1.69	-	2.2	12.0	14.2	510	2800	4100	12.66	6.8	4.30	5.30	A+	A+++	4.29	
18	13	07	05	-	4.90	3.43	2.04	1.63	-	2.2	12.0	14.2	540	2800	4100	12.66	6.8	4.30	5.30	A+	A+++	4.29	
22	13	07	05	-	5.35	3.21	1.91	1.53	-	2.2	12.0	14.2	540	2800	4100	12.66	6.8	4.30	5.30	A+	A+++	4.29	
24	13	07	05	-	5.75	3.02	1.80	1.44	-	2.2	12.0	14.2	540	2800	4100	12.66	6.8	4.30	5.30	A+	A+++	4.29	
16	16	07	05	-	4.26	4.26	1.94	1.55	-	2.2	12.0	14.2	530	2800	4100	12.66	6.8	4.30	5.30	A+	A+++	4.29	
18	16	07	05	-	4.50	4.13	1.88	1.50	-	2.2	12.0	14.2	540	2800	4100	12.66	6.8	4.30	5.30	A+	A+++	4.29	
22	16	07	05	-</																			



**RAS-5M34G3AVG-E / TR - Performances in Heating mode**

Operating status	Combination					Unit capacity (kW)					Heating capacity (kW)			Power input (W)			Operating current (A)			Lot.10		Label		COP
	Unit A	Unit B	Unit C	Unit D	Unit E	Unit A	Unit B	Unit C	Unit D	Unit E	Min.	Nom.	Max.	Min.	Nom.	Max.	Nom.	Pah	SCOP	SCOP Warm climate	Average climate	Warm climate	Nom.	
4 units operations	18	13	07	07	-	4.74	3.32	1.97	1.97	-	2.2	12.0	14.2	540	2800	4100	12.66	6.8	4.30	5.30	A+	A+++	4.29	
	22	13	07	07	-	5.19	3.11	1.85	1.85	-	2.2	12.0	14.2	540	2800	4100	12.66	6.8	4.30	5.30	A+	A+++	4.29	
	24	13	07	07	-	5.58	2.93	1.74	1.74	-	2.2	12.0	14.2	540	2800	4100	12.66	6.8	4.30	5.30	A+	A+++	4.29	
	16	16	07	07	-	4.13	4.13	1.88	1.88	-	2.2	12.0	14.2	530	2800	4100	12.66	6.8	4.30	5.30	A+	A+++	4.29	
	18	16	07	07	-	4.36	4.00	1.82	1.82	-	2.2	12.0	14.2	540	2800	4100	12.66	6.8	4.30	5.30	A+	A+++	4.29	
	22	16	07	07	-	4.80	3.77	1.71	1.71	-	2.2	12.0	14.2	540	2800	4100	12.66	6.8	4.30	5.30	A+	A+++	4.29	
	24	16	07	07	-	5.19	3.57	1.62	1.62	-	2.2	12.0	14.2	540	2800	4100	12.66	6.8	4.30	5.30	A+	A+++	4.29	
	18	18	07	07	-	4.24	4.24	1.76	1.76	-	2.2	12.0	14.2	540	2800	4100	12.66	6.8	4.30	5.30	A+	A+++	4.29	
	22	18	07	07	-	4.67	4.00	1.67	1.67	-	2.2	12.0	14.2	540	2800	4100	12.66	6.8	4.30	5.30	A+	A+++	4.29	
	24	18	07	07	-	5.05	3.79	1.58	1.58	-	2.2	12.0	14.2	540	2800	4100	12.66	6.8	4.30	5.30	A+	A+++	4.29	
	10	10	10	07	-	3.17	3.17	3.17	2.48	-	2.2	12.0	14.2	510	2800	4100	12.66	6.8	4.30	5.30	A+	A+++	4.29	
	13	10	10	07	-	3.85	2.93	2.93	2.29	-	2.2	12.0	14.2	510	2800	4100	12.66	6.8	4.30	5.30	A+	A+++	4.29	
	16	10	10	07	-	4.58	2.67	2.67	2.08	-	2.2	12.0	14.2	510	2800	4100	12.66	6.8	4.30	5.30	A+	A+++	4.29	
	18	10	10	07	-	4.83	2.58	2.58	2.01	-	2.2	12.0	14.2	540	2800	4100	12.66	6.8	4.30	5.30	A+	A+++	4.29	
	22	10	10	07	-	5.28	2.42	2.42	1.89	-	2.2	12.0	14.2	540	2800	4100	12.66	6.8	4.30	5.30	A+	A+++	4.29	
	24	10	10	07	-	5.68	2.27	2.27	1.78	-	2.2	12.0	14.2	540	2800	4100	12.66	6.8	4.30	5.30	A+	A+++	4.29	
	13	13	10	07	-	3.57	3.57	2.72	2.13	-	2.2	12.0	14.2	530	2800	4100	12.66	6.8	4.30	5.30	A+	A+++	4.29	
	16	13	10	07	-	4.29	3.27	2.49	1.95	-	2.2	12.0	14.2	530	2800	4100	12.66	6.8	4.30	5.30	A+	A+++	4.29	
	18	13	10	07	-	4.53	3.17	2.42	1.89	-	2.2	12.0	14.2	540	2800	4100	12.66	6.8	4.30	5.30	A+	A+++	4.29	
	22	13	10	07	-	4.97	2.98	2.27	1.78	-	2.2	12.0	14.2	540	2800	4100	12.66	6.8	4.30	5.30	A+	A+++	4.29	
	24	13	10	07	-	5.36	2.82	2.15	1.68	-	2.2	12.0	14.2	540	2800	4100	12.66	6.8	4.30	5.30	A+	A+++	4.29	
	16	16	10	07	-	3.95	3.95	2.30	1.80	-	2.2	12.0	14.2	530	2800	4100	12.66	6.8	4.30	5.30	A+	A+++	4.29	
	18	16	10	07	-	4.19	3.84	2.23	1.74	-	2.2	12.0	14.2	540	2800	4100	12.66	6.8	4.30	5.30	A+	A+++	4.29	
	22	16	10	07	-	4.62	3.63	2.11	1.65	-	2.2	12.0	14.2	540	2800	4100	12.66	6.8	4.30	5.30	A+	A+++	4.29	
	24	16	10	07	-	5.00	3.44	2.00	1.56	-	2.2	12.0	14.2	540	2800	4100	12.66	6.8	4.30	5.30	A+	A+++	4.29	
	18	18	10	07	-	4.07	4.07	2.17	1.69	-	2.2	12.0	14.2	540	2800	4100	12.66	6.8	4.30	5.30	A+	A+++	4.29	
	22	18	10	07	-	4.49	3.85	2.05	1.60	-	2.2	12.0	14.2	540	2800	4100	12.66	6.8	4.30	5.30	A+	A+++	4.29	
	24	18	10	07	-	4.87	3.65	1.95	1.52	-	2.2	12.0	14.2	540	2800	4100	12.66	6.8	4.30	5.30	A+	A+++	4.29	
	13	13	13	07	-	3.34	3.34	3.34	1.99	-	2.2	12.0	14.2	530	2800	4100	12.66	6.8	4.30	5.30	A+	A+++	4.29	
	16	13	13	07	-	4.02	3.07	3.07	1.83	-	2.2	12.0	14.2	530	2800	4100	12.66	6.8	4.30	5.30	A+	A+++	4.29	
	18	13	13	07	-	4.26	2.98	2.98	1.78	-	2.2	12.0	14.2	540	2800	4100	12.66	6.8	4.30	5.30	A+	A+++	4.29	
	22	13	13	07	-	4.69	2.82	2.82	1.68	-	2.2	12.0	14.2	540	2800	4100	12.66	6.8	4.30	5.30	A+	A+++	4.29	
	24	13	13	07	-	5.08	2.67	2.67	1.59	-	2.2	12.0	14.2	540	2800	4100	12.66	6.8	4.30	5.30	A+	A+++	4.29	
	16	16	13	07	-	3.73	3.73	2.85	1.69	-	2.2	12.0	14.2	530	2800	4100	12.66	6.8	4.30	5.30	A+	A+++	4.29	
	18	16	13	07	-	3.96	3.63	2.77	1.65	-	2.2	12.0	14.2	540	2800	4100	12.66	6.8	4.30	5.30	A+	A+++	4.29	
	22	16	13	07	-	4.38	3.44	2.63	1.56	-	2.2	12.0	14.2	540	2800	4100	12.66	6.8	4.30	5.30	A+	A+++	4.29	
	24	16	13	07	-	4.75	3.27	2.50	1.49	-	2.2	12.0	14.2	540	2800	4100	12.66	6.8	4.30	5.30	A+	A+++	4.29	
	18	18	13	07	-	3.85	3.85	2.70	1.60	-	2.2	12.0	14.2	540	2800	4100	12.66	6.8	4.30	5.30	A+	A+++	4.29	
	22	18	13	07	-	4.26	3.65	2.56	1.52	-	2.2	12.0	14.2	540	2800	4100	12.66	6.8	4.30	5.30	A+	A+++	4.29	
	24	18	13	07	-	4.64	3.48	2.43	1.45	-	2.2	12.0	14.2	540	2800	4100	12.66	6.8	4.30	5.30	A+	A+++	4.29	
	10	10	10	10	-	3.00	3.00	3.00	3.00	-	2.2	12.0	14.2	510	2800	4100	12.66	6.8	4.30	5.30	A+	A+++	4.29	
	13	10	10	10	-	3.65	2.78	2.78	2.78	-	2.2	12.0	14.2	510	2800	4100	12.66	6.8	4.30	5.30	A+	A+++	4.29	
	16	10	10	10	-	4.37	2.54	2.54	2.54	-	2.2	12.0	14.2	510	2800	4100	12.66	6.8	4.30	5.30	A+	A+++	4.29	
	18	10	10	10	-	4.62	2.46	2.46	2.46	-	2.2	12.0	14.2	540	2800	4100	12.66	6.8	4.30	5.30	A+	A+++	4.29	
	22	10	10	10	-	5.06	2.31	2.31	2.31	-	2.2	12.0	14.2	540	2800	4100	12.66	6.8	4.30	5.30	A+	A+++	4.29	
	24	10	10	10	-	5.45	2.18	2.18	2.18	-	2.2	12.0	14.2	540	2800	4100	12.66	6.8	4.30	5.30	A+	A+++	4.29	
	13	13	10	10	-	3.41	3.41	2.59	2.59	-	2.2	12.0	14.2	530	2800	4100	12.66	6.8	4.30	5.30	A+	A+++	4.29	
	16	13	10	10	-	4.10	3.13	2.39	2.39	-	2.2	12.0	14.2	530	2800	4100	12.66	6.8	4.30	5.30	A+	A+++	4.29	
18	13	10	10	-	4.34	3.04	2.31	2.31	-	2.2	12.0	14.2	540	2800	4100	12.66	6.8	4.30	5.30	A+	A+++	4.29		
22	13	10	10	-	4.77	2.86	2.18	2.18	-	2.2	12.0	14.2	540	2800	4100	12.66	6.8	4.30	5.30	A+	A+++	4.29		
24	13	10	10	-	5.16	2.71	2.06	2.06	-	2.2	12.0	14.2	540	2800	4100	12.66	6.8	4.30	5.30	A+	A+++	4.29		
16	16	10	10	-	3.79	3.79	2.21	2.21	-	2.2	12.0	14.2	530	2800	4100	12.66	6.8	4.30	5.30	A+	A+++	4.29		
18	16	10	10	-	4.02	3.69	2.15	2.15	-	2.2	12.0	14.2	540	2800	4100	12.66	6.8	4.30	5.30	A+	A+++	4.29		
22	16	10	10	-	4.44	3.49	2.03	2.03	-	2.2	12.0	14.2	540	2800	4100	12.66	6.8	4.30	5.30	A+	A+++	4.29		
24	16	10	10	-	4.82	3.32	1.93	1.93	-	2.2	12.0	14.2	540	2800	4100	12.66	6.8	4.30	5.30	A+	A+++	4.29		
18	18	10	10	-	3.91	3.91	2.09	2.09	-	2.2	12.0	14.2	540	2800	4100	12.66	6.8	4.30	5.30	A+	A+++	4.29		
22	18	10	10	-	4.33	3.71	1.98	1.98	-	2.2	12.0	14.2	540	2800	4100	12.66	6.8	4.30	5.30	A+	A+++	4.29		
24	18	10	10	-	4.71	3.53	1.88	1.88	-	2.2	12.0	14.2	540	2800	4100	12.66	6.8	4.30	5.30	A+	A+++	4.29		
13	13	13	10	-	3.19	3.19	3.19	2.43	-	2.2	12.0	14.2	530	2800	4100	12.66	6.8	4.30	5.30	A+	A+++	4.29		
16	13	13	10	-	3.86	2.95	2.95	2.25	-	2.2	12.0	14.2	530	2800	4100	12.66	6.8	4.30	5.30	A+	A+++	4.29		
18	13	13	10	-	4.09	2.86	2.86	2.18	-	2.2	12.0	14.2	540	2800	4100	12.66	6.8	4.30	5.30	A+	A+++	4.29		
22	13	13	10	-	4.52	2.71	2.71	2.06	-	2.2	12.0	14.2	540	2800	4100	12.66	6.8	4.30	5.30	A+	A+++	4.29		
24	13	13	10	-	4.90	2.57	2.57	1.96	-	2.2	12.0	14.2	540	2800	4100	12.66	6.8	4.30	5.30	A+	A+++	4.29		
16	16	13	10	-	3.59	3.59	2.74	2.09	-	2.2														



RAS-5M34G3AVG-E / TR - Performances in Heating mode

Operating status	Combination					Unit capacity (kW)					Heating capacity (kW)			Power input (W)			Operating current (A)			Label	COP		
	Unit A	Unit B	Unit C	Unit D	Unit E	Unit A	Unit B	Unit C	Unit D	Unit E	Min.	Nom.	Max.	Min.	Nom.	Max.	Nom.	Pch	SCOP			SCOP Warm climate	Average climate
5 units operations	18	13	05	05	05	4.44	3.11	1.48	1.48	1.48	2.2	12.0	14.2	530	2800	4100	12.66	6.8	4.30	5.30	A+	A+++	4.29
	16	16	05	05	05	3.88	3.88	1.41	1.41	1.41	2.2	12.0	14.2	510	2800	4100	12.66	6.8	4.30	5.30	A+	A+++	4.29
	18	16	05	05	05	4.11	3.77	1.37	1.37	1.37	2.2	12.0	14.2	540	2800	4100	12.66	6.8	4.30	5.30	A+	A+++	4.29
	18	18	05	05	05	4.00	4.00	1.33	1.33	1.33	2.2	12.0	14.2	540	2800	4100	12.66	6.8	4.30	5.30	A+	A+++	4.29
	07	07	07	05	05	2.50	2.50	2.50	2.00	2.00	2.2	11.5	14.2	490	2700	4100	12.20	6.5	4.20	5.20	A+	A+++	4.26
	10	07	07	05	05	3.15	2.46	2.46	1.97	1.97	2.2	12.0	14.2	490	2800	4100	12.66	6.8	4.30	5.30	A+	A+++	4.29
	13	07	07	05	05	3.82	2.27	2.27	1.82	1.82	2.2	12.0	14.2	510	2800	4100	12.66	6.8	4.30	5.30	A+	A+++	4.29
	16	07	07	05	05	4.55	2.07	2.07	1.66	1.66	2.2	12.0	14.2	510	2800	4100	12.66	6.8	4.30	5.30	A+	A+++	4.29
	18	07	07	05	05	4.80	2.00	2.00	1.60	1.60	2.2	12.0	14.2	530	2800	4100	12.66	6.8	4.30	5.30	A+	A+++	4.29
	10	10	07	05	05	2.98	2.98	2.33	1.86	1.86	2.2	12.0	14.2	490	2800	4100	12.66	6.8	4.30	5.30	A+	A+++	4.29
	13	10	07	05	05	3.63	2.76	2.16	1.73	1.73	2.2	12.0	14.2	510	2800	4100	12.66	6.8	4.30	5.30	A+	A+++	4.29
	16	10	07	05	05	4.34	2.53	1.97	1.58	1.58	2.2	12.0	14.2	510	2800	4100	12.66	6.8	4.30	5.30	A+	A+++	4.29
	18	10	07	05	05	4.59	2.45	1.91	1.53	1.53	2.2	12.0	14.2	530	2800	4100	12.66	6.8	4.30	5.30	A+	A+++	4.29
	13	13	07	05	05	3.38	3.38	2.01	1.61	1.61	2.2	12.0	14.2	510	2800	4100	12.66	6.8	4.30	5.30	A+	A+++	4.29
	16	13	07	05	05	4.07	3.11	1.85	1.48	1.48	2.2	12.0	14.2	510	2800	4100	12.66	6.8	4.30	5.30	A+	A+++	4.29
	18	13	07	05	05	4.31	3.02	1.80	1.44	1.44	2.2	12.0	14.2	540	2800	4100	12.66	6.8	4.30	5.30	A+	A+++	4.29
	16	16	07	05	05	3.77	3.77	1.71	1.37	1.37	2.2	12.0	14.2	510	2800	4100	12.66	6.8	4.30	5.30	A+	A+++	4.29
	18	16	07	05	05	4.00	3.67	1.67	1.33	1.33	2.2	12.0	14.2	540	2800	4100	12.66	6.8	4.30	5.30	A+	A+++	4.29
	10	10	10	05	05	2.82	2.82	2.82	1.76	1.76	2.2	12.0	14.2	490	2800	4100	12.66	6.8	4.30	5.30	A+	A+++	4.29
	13	10	10	05	05	3.45	2.63	2.63	1.64	1.64	2.2	12.0	14.2	510	2800	4100	12.66	6.8	4.30	5.30	A+	A+++	4.29
	16	10	10	05	05	4.15	2.42	2.42	1.51	1.51	2.2	12.0	14.2	510	2800	4100	12.66	6.8	4.30	5.30	A+	A+++	4.29
	18	10	10	05	05	4.39	2.34	2.34	1.46	1.46	2.2	12.0	14.2	530	2800	4100	12.66	6.8	4.30	5.30	A+	A+++	4.29
	13	13	10	05	05	3.23	3.23	2.46	1.54	1.54	2.2	12.0	14.2	510	2800	4100	12.66	6.8	4.30	5.30	A+	A+++	4.29
	07	07	07	07	05	2.50	2.50	2.50	2.50	2.00	2.2	12.0	14.2	510	2800	4100	12.66	6.8	4.30	5.30	A+	A+++	4.29
	10	07	07	07	05	3.02	2.36	2.36	2.36	1.89	2.2	12.0	14.2	510	2800	4100	12.66	6.8	4.30	5.30	A+	A+++	4.29
	13	07	07	07	05	3.68	2.19	2.19	2.19	1.75	2.2	12.0	14.2	510	2800	4100	12.66	6.8	4.30	5.30	A+	A+++	4.29
	16	07	07	07	05	4.40	2.00	2.00	2.00	1.60	2.2	12.0	14.2	510	2800	4100	12.66	6.8	4.30	5.30	A+	A+++	4.29
	18	07	07	07	05	4.65	1.94	1.94	1.94	1.55	2.2	12.0	14.2	540	2800	4100	12.66	6.8	4.30	5.30	A+	A+++	4.29
	10	10	07	07	05	2.87	2.87	2.24	2.24	1.79	2.2	12.0	14.2	510	2800	4100	12.66	6.8	4.30	5.30	A+	A+++	4.29
	13	10	07	07	05	3.50	2.67	2.08	2.08	1.67	2.2	12.0	14.2	510	2800	4100	12.66	6.8	4.30	5.30	A+	A+++	4.29
	16	10	07	07	05	4.20	2.45	1.91	1.91	1.53	2.2	12.0	14.2	510	2800	4100	12.66	6.8	4.30	5.30	A+	A+++	4.29
	18	10	07	07	05	4.44	2.37	1.85	1.85	1.48	2.2	12.0	14.2	540	2800	4100	12.66	6.8	4.30	5.30	A+	A+++	4.29
	13	13	07	07	05	3.27	3.27	1.95	1.95	1.56	2.2	12.0	14.2	530	2800	4100	12.66	6.8	4.30	5.30	A+	A+++	4.29
	16	13	07	07	05	3.95	3.02	1.80	1.80	1.44	2.2	12.0	14.2	530	2800	4100	12.66	6.8	4.30	5.30	A+	A+++	4.29
	10	10	10	07	05	2.72	2.72	2.72	2.13	1.70	2.2	12.0	14.2	510	2800	4100	12.66	6.8	4.30	5.30	A+	A+++	4.29
	13	10	10	07	05	3.34	2.54	2.54	1.99	1.59	2.2	12.0	14.2	510	2800	4100	12.66	6.8	4.30	5.30	A+	A+++	4.29
	16	10	10	07	05	4.02	2.34	2.34	1.83	1.46	2.2	12.0	14.2	510	2800	4100	12.66	6.8	4.30	5.30	A+	A+++	4.29
	10	10	10	10	05	2.59	2.59	2.59	2.59	1.62	2.2	12.0	14.2	510	2800	4100	12.66	6.8	4.30	5.30	A+	A+++	4.29
	07	07	07	07	07	2.40	2.40	2.40	2.40	2.40	2.2	12.0	14.2	510	2800	4100	12.66	6.8	4.30	5.30	A+	A+++	4.29
	10	07	07	07	07	2.91	2.27	2.27	2.27	2.27	2.2	12.0	14.2	510	2800	4100	12.66	6.8	4.30	5.30	A+	A+++	4.29
	13	07	07	07	07	3.55	2.11	2.11	2.11	2.11	2.2	12.0	14.2	510	2800	4100	12.66	6.8	4.30	5.30	A+	A+++	4.29
	16	07	07	07	07	4.26	1.94	1.94	1.94	1.94	2.2	12.0	14.2	530	2800	4100	12.66	6.8	4.30	5.30	A+	A+++	4.29
	18	07	07	07	07	4.50	1.88	1.88	1.88	1.88	2.2	12.0	14.2	540	2800	4100	12.66	6.8	4.30	5.30	A+	A+++	4.29
	10	10	07	07	07	2.76	2.76	2.16	2.16	2.16	2.2	12.0	14.2	510	2800	4100	12.66	6.8	4.30	5.30	A+	A+++	4.29
	13	10	07	07	07	3.38	2.58	2.01	2.01	2.01	2.2	12.0	14.2	510	2800	4100	12.66	6.8	4.30	5.30	A+	A+++	4.29
	16	10	07	07	07	4.07	2.37	1.85	1.85	1.85	2.2	12.0	14.2	530	2800	4100	12.66	6.8	4.30	5.30	A+	A+++	4.29
	18	10	07	07	07	4.31	2.30	1.80	1.80	1.80	2.2	12.0	14.2	540	2800	4100	12.66	6.8	4.30	5.30	A+	A+++	4.29
	13	13	07	07	07	3.17	3.17	1.89	1.89	1.89	2.2	12.0	14.2	530	2800	4100	12.66	6.8	4.30	5.30	A+	A+++	4.29
	16	13	07	07	07	3.84	2.93	1.74	1.74	1.74	2.2	12.0	14.2	530	2800	4100	12.66	6.8	4.30	5.30	A+	A+++	4.29
	18	13	07	07	07	4.07	2.85	1.69	1.69	1.69	2.2	12.0	14.2	540	2800	4100	12.66	6.8	4.30	5.30	A+	A+++	4.29
16	16	07	07	07	3.57	3.57	1.62	1.62	1.62	2.2	12.0	14.2	530	2800	4100	12.66	6.8	4.30	5.30	A+	A+++	4.29	
18	16	07	07	07	3.79	3.47	1.58	1.58	1.58	2.2	12.0	14.2	540	2800	4100	12.66	6.8	4.30	5.30	A+	A+++	4.29	
10	10	10	07	07	2.63	2.63	2.63	2.05	2.05	2.2	12.0	14.2	510	2800	4100	12.66	6.8	4.30	5.30	A+	A+++	4.29	
13	10	10	07	07	3.23	2.46	2.46	1.92	1.92	2.2	12.0	14.2	510	2800	4100	12.66	6.8	4.30	5.30	A+	A+++	4.29	
16	10	10	07	07	3.91	2.27	2.27	1.78	1.78	2.2	12.0	14.2	530	2800	4100	12.66	6.8	4.30	5.30	A+	A+++	4.29	
18	10	10	07	07	4.14	2.21	2.21	1.72	1.72	2.2	12.0	14.2	540	2800	4100	12.66	6.8	4.30	5.30	A+	A+++	4.29	
13	13	10	07	07	3.04	3.04	2.31	1.81	1.81	2.2	12.0	14.2	530	2800	4100	12.66	6.8	4.30	5.30	A+	A+++	4.29	
16	13	10	07	07	3.69	2.82	2.15	1.68	1.68	2.2	12.0	14.2	530	2800	4100	12.66	6.8	4.30	5.30	A+	A+++	4.29	
18	13	10	07	07	3.91	2.74	2.09	1.63	1.63	2.2	12.0	14.2	540	2800	4100	12.66	6.8	4.30	5.30	A+	A+++	4.29	
16	16	10	07	07	3.44	3.44	2.00	1.56	1.56	2.2	12.0	14.2	530	2800	4100	12.66	6.8	4.30	5.30	A+	A+++	4.29	
18	16	10	07	07	3.65	3.35	1.95	1.52	1.52	2.2	12.0	14.2	540	2800	4100	12.66	6.8	4.30	5.30	A+	A+++	4.29	
13	13	13	07	07	2.86	2.86	2.86	1.70	1.70	2.2	12.0	14.2	530	2800	4100	12.66	6.8	4.30	5.30				



**RAS-5M34U2AVG-E / TR - Performances in Heating mode**

Operating status	Combination					Unit capacity (kW)					Heating capacity (kW)			Power input (W)			Operating current (A)		Lot.10		Label		COP
	Unit A	Unit B	Unit C	Unit D	Unit E	Unit A	Unit B	Unit C	Unit D	Unit E	Min.	Nom.	Max.	Min.	Nom.	Max.	Nom.	Pah	SCOP	SCOP Warm climate	Average climate	Warm climate	
5 units operations	16	13	13	13	13	2.96	2.26	2.26	2.26	2.26	2.2	12.0	14.2	540	2800	4100	12.66	6.8	4.30	5.30	A+	A+++	4.29
	22	05	05	05	05	5.60	1.60	1.60	1.60	1.60	2.2	12.0	14.2	530	2800	4100	12.66	6.8	4.30	5.30	A+	A+++	4.29
	24	05	05	05	05	6.00	1.50	1.50	1.50	1.50	2.2	12.0	14.2	540	2800	4100	12.66	6.8	4.30	5.30	A+	A+++	4.29
	22	07	05	05	05	5.42	1.94	1.55	1.55	1.55	2.2	12.0	14.2	540	2800	4100	12.66	6.8	4.30	5.30	A+	A+++	4.29
	24	07	05	05	05	5.82	1.82	1.45	1.45	1.45	2.2	12.0	14.2	540	2800	4100	12.66	6.8	4.30	5.30	A+	A+++	4.29
	22	10	05	05	05	5.19	2.37	1.48	1.48	1.48	2.2	12.0	14.2	540	2800	4100	12.66	6.8	4.30	5.30	A+	A+++	4.29
	24	10	05	05	05	5.58	2.23	1.40	1.40	1.40	2.2	12.0	14.2	540	2800	4100	12.66	6.8	4.30	5.30	A+	A+++	4.29
	22	13	05	05	05	4.88	2.93	1.40	1.40	1.40	2.2	12.0	14.2	540	2800	4100	12.66	6.8	4.30	5.30	A+	A+++	4.29
	24	13	05	05	05	5.27	2.77	1.32	1.32	1.32	2.2	12.0	14.2	540	2800	4100	12.66	6.8	4.30	5.30	A+	A+++	4.29
	22	07	07	05	05	5.25	1.88	1.88	1.50	1.50	2.2	12.0	14.2	540	2800	4100	12.66	6.8	4.30	5.30	A+	A+++	4.29
	24	07	07	05	05	5.65	1.76	1.76	1.41	1.41	2.2	12.0	14.2	540	2800	4100	12.66	6.8	4.30	5.30	A+	A+++	4.29
	22	10	07	05	05	5.03	2.30	1.80	1.44	1.44	2.2	12.0	14.2	540	2800	4100	12.66	6.8	4.30	5.30	A+	A+++	4.29
	24	10	07	05	05	5.42	2.17	1.69	1.36	1.36	2.2	12.0	14.2	540	2800	4100	12.66	6.8	4.30	5.30	A+	A+++	4.29
	22	13	07	05	05	4.75	2.85	1.69	1.36	1.36	2.2	12.0	14.2	540	2800	4100	12.66	6.8	4.30	5.30	A+	A+++	4.29
	24	13	07	05	05	5.13	2.70	1.60	1.28	1.28	2.2	12.0	14.2	540	2800	4100	12.66	6.8	4.30	5.30	A+	A+++	4.29
	22	10	10	05	05	4.83	2.21	2.21	1.38	1.38	2.2	12.0	14.2	540	2800	4100	12.66	6.8	4.30	5.30	A+	A+++	4.29
	24	10	10	05	05	5.22	2.09	2.09	1.30	1.30	2.2	12.0	14.2	540	2800	4100	12.66	6.8	4.30	5.30	A+	A+++	4.29
	22	13	10	05	05	4.57	2.74	2.09	1.30	1.30	2.2	12.0	14.2	540	2800	4100	12.66	6.8	4.30	5.30	A+	A+++	4.29
	24	13	10	05	05	4.95	2.60	1.98	1.24	1.24	2.2	12.0	14.2	540	2800	4100	12.66	6.8	4.30	5.30	A+	A+++	4.29
	22	13	13	05	05	4.33	2.60	2.60	1.24	1.24	2.2	12.0	14.2	540	2800	4100	12.66	6.8	4.30	5.30	A+	A+++	4.29
	24	13	13	05	05	4.71	2.47	2.47	1.18	1.18	2.2	12.0	14.2	540	2800	4100	12.66	6.8	4.30	5.30	A+	A+++	4.29
	22	07	07	07	05	5.09	1.82	1.82	1.82	1.45	2.2	12.0	14.2	540	2800	4100	12.66	6.8	4.30	5.30	A+	A+++	4.29
	24	07	07	07	05	5.49	1.71	1.71	1.71	1.37	2.2	12.0	14.2	540	2800	4100	12.66	6.8	4.30	5.30	A+	A+++	4.29
	22	10	07	07	05	4.88	2.23	1.74	1.74	1.40	2.2	12.0	14.2	540	2800	4100	12.66	6.8	4.30	5.30	A+	A+++	4.29
	24	10	07	07	05	5.27	2.11	1.65	1.65	1.32	2.2	12.0	14.2	540	2800	4100	12.66	6.8	4.30	5.30	A+	A+++	4.29
	22	13	07	07	05	4.62	2.77	1.65	1.65	1.32	2.2	12.0	14.2	540	2800	4100	12.66	6.8	4.30	5.30	A+	A+++	4.29
	24	13	07	07	05	5.00	2.63	1.56	1.56	1.25	2.2	12.0	14.2	540	2800	4100	12.66	6.8	4.30	5.30	A+	A+++	4.29
	22	10	10	07	05	4.69	2.15	2.15	1.68	1.34	2.2	12.0	14.2	540	2800	4100	12.66	6.8	4.30	5.30	A+	A+++	4.29
	24	10	10	07	05	5.08	2.03	2.03	1.59	1.27	2.2	12.0	14.2	540	2800	4100	12.66	6.8	4.30	5.30	A+	A+++	4.29
	22	13	10	07	05	4.44	2.67	2.03	1.59	1.27	2.2	12.0	14.2	540	2800	4100	12.66	6.8	4.30	5.30	A+	A+++	4.29
	24	13	10	07	05	4.82	2.53	1.93	1.51	1.21	2.2	12.0	14.2	540	2800	4100	12.66	6.8	4.30	5.30	A+	A+++	4.29
	22	13	13	07	05	4.22	2.53	2.53	1.51	1.21	2.2	12.0	14.2	540	2800	4100	12.66	6.8	4.30	5.30	A+	A+++	4.29
	24	13	13	07	05	4.59	2.41	2.41	1.44	1.15	2.2	12.0	14.2	540	2800	4100	12.66	6.8	4.30	5.30	A+	A+++	4.29
	22	10	10	10	05	4.52	2.06	2.06	2.06	1.29	2.2	12.0	14.2	540	2800	4100	12.66	6.8	4.30	5.30	A+	A+++	4.29
	24	10	10	10	05	4.90	1.96	1.96	1.96	1.22	2.2	12.0	14.2	540	2800	4100	12.66	6.8	4.30	5.30	A+	A+++	4.29
	22	13	10	10	05	4.29	2.57	1.96	1.96	1.22	2.2	12.0	14.2	540	2800	4100	12.66	6.8	4.30	5.30	A+	A+++	4.29
	24	13	10	10	05	4.66	2.45	1.86	1.86	1.17	2.2	12.0	14.2	540	2800	4100	12.66	6.8	4.30	5.30	A+	A+++	4.29
	22	13	13	10	05	4.08	2.45	2.45	1.86	1.17	2.2	12.0	14.2	540	2800	4100	12.66	6.8	4.30	5.30	A+	A+++	4.29
	24	13	13	10	05	4.44	2.33	2.33	1.78	1.11	2.2	12.0	14.2	540	2800	4100	12.66	6.8	4.30	5.30	A+	A+++	4.29
	22	13	13	13	05	3.89	2.33	2.33	2.33	1.11	2.2	12.0	14.2	540	2800	4100	12.66	6.8	4.30	5.30	A+	A+++	4.29
	22	07	07	07	07	4.94	1.76	1.76	1.76	1.76	2.2	12.0	14.2	540	2800	4100	12.66	6.8	4.30	5.30	A+	A+++	4.29
	24	07	07	07	07	5.33	1.67	1.67	1.67	1.67	2.2	12.0	14.2	540	2800	4100	12.66	6.8	4.30	5.30	A+	A+++	4.29
	22	10	07	07	07	4.75	2.17	1.69	1.69	1.69	2.2	12.0	14.2	540	2800	4100	12.66	6.8	4.30	5.30	A+	A+++	4.29
	24	10	07	07	07	5.13	2.05	1.60	1.60	1.60	2.2	12.0	14.2	540	2800	4100	12.66	6.8	4.30	5.30	A+	A+++	4.29
	22	13	07	07	07	4.49	2.70	1.60	1.60	1.60	2.2	12.0	14.2	540	2800	4100	12.66	6.8	4.30	5.30	A+	A+++	4.29
	24	13	07	07	07	4.87	2.56	1.52	1.52	1.52	2.2	12.0	14.2	540	2800	4100	12.66	6.8	4.30	5.30	A+	A+++	4.29
	22	10	10	07	07	4.57	2.09	2.09	1.63	1.63	2.2	12.0	14.2	540	2800	4100	12.66	6.8	4.30	5.30	A+	A+++	4.29
	24	10	10	07	07	4.95	1.98	1.98	1.55	1.55	2.2	12.0	14.2	540	2800	4100	12.66	6.8	4.30	5.30	A+	A+++	4.29
	22	13	10	07	07	4.33	2.60	1.98	1.55	1.55	2.2	12.0	14.2	540	2800	4100	12.66	6.8	4.30	5.30	A+	A+++	4.29
	24	13	10	07	07	4.71	2.47	1.88	1.47	1.47	2.2	12.0	14.2	540	2800	4100	12.66	6.8	4.30	5.30	A+	A+++	4.29
22	13	13	07	07	4.12	2.47	2.47	1.47	1.47	2.2	12.0	14.2	540	2800	4100	12.66	6.8	4.30	5.30	A+	A+++	4.29	
24	13	13	07	07	4.49	2.36	2.36	1.40	1.40	2.2	12.0	14.2	540	2800	4100	12.66	6.8	4.30	5.30	A+	A+++	4.29	
22	10	10	10	07	4.40	2.01	2.01	2.01	1.57	2.2	12.0	14.2	540	2800	4100	12.66	6.8	4.30	5.30	A+	A+++	4.29	
24	10	10	10	07	4.78	1.91	1.91	1.91	1.49	2.2	12.0	14.2	540	2800	4100	12.66	6.8	4.30	5.30	A+	A+++	4.29	
22	13	10	10	07	4.18	2.51	1.91	1.91	1.49	2.2	12.0	14.2	540	2800	4100	12.66	6.8	4.30	5.30	A+	A+++	4.29	
24	13	10	10	07	4.55	2.39	1.82	1.82	1.42	2.2	12.0	14.2	540	2800	4100	12.66	6.8	4.30	5.30	A+	A+++	4.29	
22	13	13	10	07	3.98	2.39	2.39	1.82	1.42	2.2	12.0	14.2	540	2800	4100	12.66	6.8	4.30	5.30	A+	A+++	4.29	
24	13	13	10	07	4.34	2.28	2.28	1.74	1.36	2.2	12.0	14.2	540	2800	4100	12.66	6.8	4.30	5.30	A+	A+++	4.29	
22	13	13	13	07	3.80	2.28	2.28	2.28	1.36	2.2	12.0	14.2	540	2800	4100	12.66	6.8	4.30	5.30	A+	A+++	4.29	
22	10	10	10	10	4.24	1.94	1.94	1.94	1.94	2.2	12.0	14.2	540	2800	4100	12.66	6.8	4.30	5.30	A+	A+++	4.29	
24	10	10	10	10	4.62	1.85	1.85	1.85	1.85	2.2	12.0	14.2	540	2800	4100	12.66	6.8	4.30	5.30	A+	A+++	4.29	
22	13	10	10	10	4.04	2.42	1.85	1.85	1.85	2.2													





RESIDENTIAL LIGHT COMMERCIAL BUSINESS RESIDENTIAL



## Solutions for professionals, by professionals

Toshiba Digital and Super Digital Inverter systems provide exceptional operating savings and extremely compact units. With state-of-the-art technologies, flexible controls and improved installation, they ensure comfort and convenience for all business installations.

A complete range of indoor units to suit all commercial applications: ceiling, cassette, ducted, suspended and high-wall. The range has been expanded with maximum cooling capacities of up to 27kW to benefit additional commercial applications with larger volumes.



> LIGHT  
COMMERCIAL

LIGHT COMMERCIAL BUSINESS RESIDENTIAL



## SYSTEMY INVERTEROWE



### KIEDY INVERTER STAJE SIĘ DIGITALEM

Technologia Toshiba odtwarza z sygnału zasilania odpowiednią częstotliwość, aby idealnie napędzać sprężarkę.

### WYSOKA WYDAJNOŚĆ I NISKIE ZUŻYCIE ENERGII

Digital Inverter i Super Digital Inverter są w stanie zapewnić wysoką wydajność, niskie zużycie energii, najwyższy komfort i mniejsze straty energii niezależnie od warunków.

### NIEZWYKŁA ELASTYCZNOŚĆ

Wyposażone w bardziej kompaktową obudowę, Digital Inverter i Super Digital Inverter wykorzystują zaawansowane technologie, takie jak hybrydowe sterowanie DC i podwójna sprężarka rotacyjna, aby działać płynnie w temperaturach od -27 do 52°C bez względu na otoczenie.

Technologia Inverterowa stworzona przez TOSHIBA

SEER do <b>9.4</b>	SCOP do <b>5.5</b>	11 rozmiarów 2,5 do 22,5 kW (chłodzenie) 3,4 do 27 kW (ogrzewanie)
 Cicha Praca	CDU obniżone do <b>38 dB(A)</b>	Dostępne w 1 Ph i 3 Ph



### WYBIERZ ROZWIĄZANIE, KTÓRE ODPOWIADA TWOIM POTRZEBOM

				WYDAJNOŚĆ WHP										
				1	1,5	2	3	3,5	4	5	6	8	10	W-Twin
				1Ph			1Ph & 3Ph			3Ph		W-Twin		
R32 Outdoor units	Super Digital Inverter	RAV-GP***1AT(8)(W)-E/-TR				✓	✓		✓	✓	✓ (3Ph only)			Twin
	Digital Inverter and Big Digital Inverter <span style="color: red; font-weight: bold;">&gt;NEW</span>	RAV-GM***2AT(8)(P)(W)-E/-TR & RAV-GM***1AT8P-E/-TR		✓	✓	✓	✓	✓	✓	✓	✓	✓	✓	Twin, Triple & W-Twin
	Digital Inverter classic	RAV-GV***1AT(8)(P)-E/-TR				✓	✓		✓	✓	✓			
R32 indoor units	4-way smart cassette	RAV-HM***1UT-E/-TR				✓	✓		✓	✓				
	4-way standard cassette	RAV-HM***1UTP-E/-TR				✓	✓	✓	✓	✓	✓			
	Compact 4-way cassette	RAV-HM***1MUT-E/-TR		✓	✓	✓								
	1-way cassette <span style="color: red; font-weight: bold;">&gt;NEW</span>	RAV-HM***1U1TP-E		✓	✓									
	Standard duct	RAV-HM***1BTP-E/-TR				✓	✓	✓	✓	✓	✓			
	Slim duct <span style="color: red; font-weight: bold;">&gt;NEW</span>	RAV-HM***1SDTY-E/-TR		✓	✓	✓	✓							
	High static duct	RAV-RM***1HTP-E/-TR										✓	✓	
	Ceiling	RAV-HM***1CTP-E/-TR			✓	✓	✓	✓	✓	✓	✓			
	High Wall	RAV-HM***1KRTP-E/-TR		✓	✓	✓	✓	✓						
	Floor standing	RAV-HM***1FT-E/-TR				✓	✓		✓	✓	✓			
	Standard DX kit	RAV-DXC010		✓	✓	✓	✓	✓	✓	✓	✓			
	0/10v DX kit	RBC-DXC031		✓	✓	✓	✓	✓	✓	✓	✓	✓	✓	✓

RAV  
**SUPER DIGITAL INVERTER**

Super Digital Inverter will maximize your energy savings and keep operating costs to a minimum thanks to Toshiba's legendary Twin Rotary compressors and Vector Controlled Inverter.

Benefit also from all the connectivity and flexibility you have ever dreamt of for guaranteed comfort and exceptional efficiency. Choosing Toshiba's light commercial advanced solutions is the right option for low environmental impact and outstanding durable investments

**MAXIMUM EFFICIENCY**

Very efficient energy consumption, keeps down operating costs : SEER of 9,40 and SCOP of 5,51 achieved by Toshiba's unrivalled Super Digital Inverter technologies and newly developed components.



- Top class seasonal efficiency
- Lower stand-by power
- Energy monitoring
- Wider operating range

**PIPING FLEXIBILITY**

Super Digital Inverter leads the industry with support for height differences of up to 30 meters on a single system. That is enough height to cover an 8-storey building. Enable the outdoor unit to be installed out of sight increases installation flexibility (only 4 & 5HP).

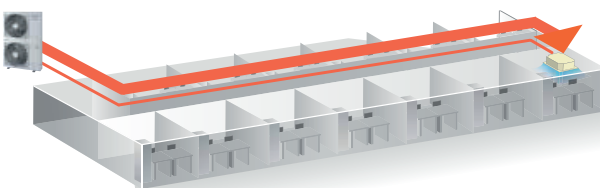

Farthest equivalent length 75m

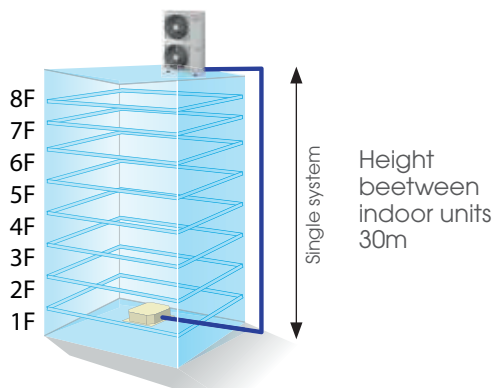

Calculated at 3.5 metres per floor

**IDEAL COUPLE: DC TWIN ROTARY COMPRESSOR & VECTOR-CONTROLLED INVERTER**

The benefits of inverter technology are further optimised in combination with Toshiba twin-rotary compressors. These allows excellent speed control in the capacity range from 20 to 100% capacity; this is an exclusive Toshiba benefit!



**OPERATING TEMPERATURE RANGE**

Heater operation is possible starting from an outdoor temperature of -27°C creates a comfortable space even during cold winters, while cooling operation is possible up to 52°C outdoor temperature. This enables wider applications and use of the system in colder regions.

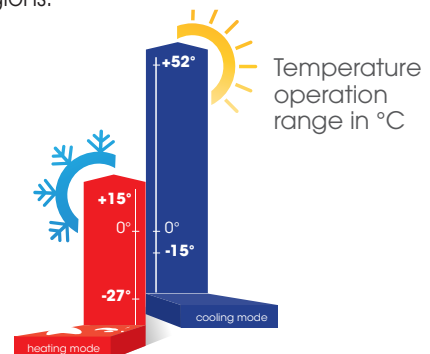

LIGHT COMMERCIAL

# RAV DIGITAL INVERTER



Digital Inverter combines compact chassis outdoor units, unrivalled capacity range and large indoor unit line-up for perfect adaptation to any situation. This is the ultimate high efficiency solution for light commercial applications in terms of product reliability and quality.

## SMALL AND LIGHT CHASSIS

Using 1-fan chassis for all sizes, the Digital inverter is extremely compact and can be installed in very small places.



## SMART INVERTER

Hybrid inverter control combines two intelligent controls mechanisms to reach the setpoint temperature as quickly as possible with maximum efficiency:

- the PAM mode, quickly achieves high capacity and desired comfort.
- the PWM mode minimises power input to maximise efficiency.

The result: high efficiency level.

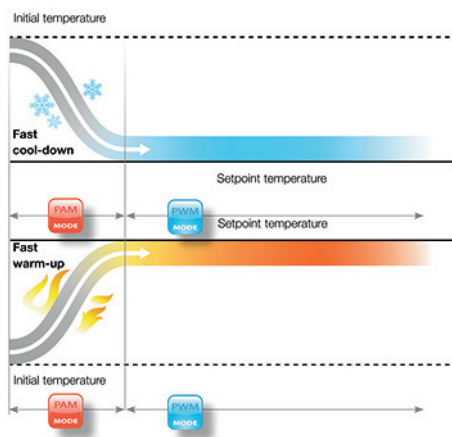

## OPERATING TEMPERATURE RANGE

Heater operation is possible starting from an outdoor temperature of -15°C (-27°C for Big DI), while cooling operation is possible at -15°C and up to 46°C outdoor temperature.

This enables wider applications and usage of the system everywhere.

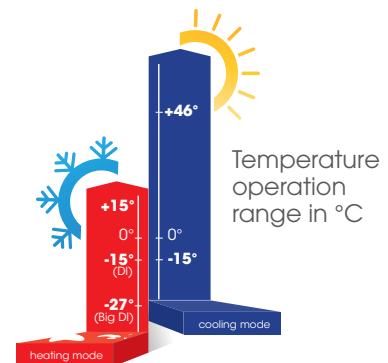

## WIDE CAPACITY RANGE

9 sizes from 1 HP to 10HP with 1Ph or 3Ph electrical connections to cover every type of projects from the 15m<sup>2</sup> room to the 200m<sup>2</sup> shop in both new construction and refurbishment.

		1HP	1.5HP	2HP	3HP	3.5HP	4HP	5HP	6HP	8HP	10HP
TOSHIBA R32 REFRIGERANT	1Ph	✓	✓	✓	✓	✓	✓	✓	✓		
	3Ph						✓	✓	✓	✓	✓



# > RAV DIGITAL INVERTER CLASSIC

Digital Inverter Classic offers all of Toshiba expertise at an affordable cost for a wide range of light commercial applications.

## COMPACT CHASSIS

With a width of less than 900mm, the Digital Inverter Classic is extremely compact and can be installed in small places.

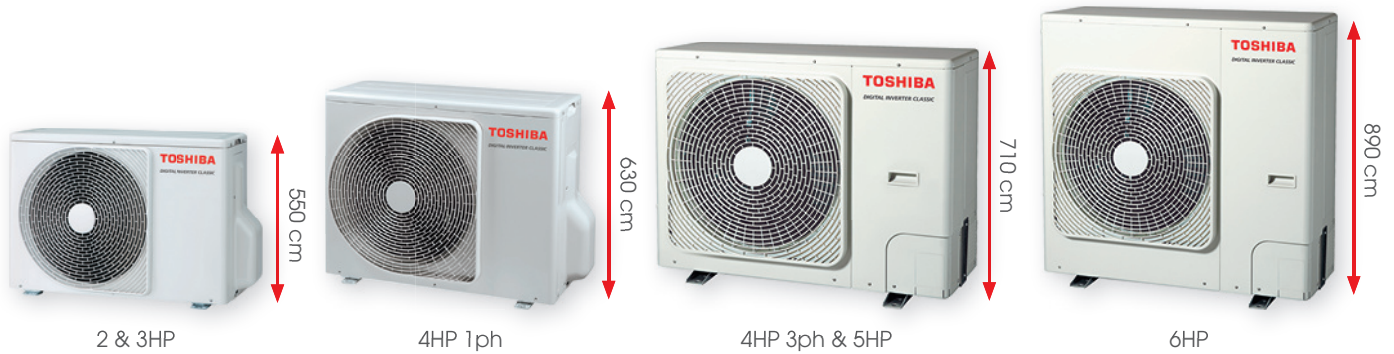

## TOSHIBA EXPERTISE

Twin rotary compressor, heat exchanger or hybrid inverter demonstrate the innovative technology Toshiba has been developing since the 80's making the Digital Inverter Classic a brilliant solution.



## OPERATING TEMPERATURE RANGE

Heater operation is possible starting from an outdoor temperature of -15°C, while cooling operation is possible at -15°C and up to 46°C outdoor temperature. This enables wider applications and usage of the system everywhere.

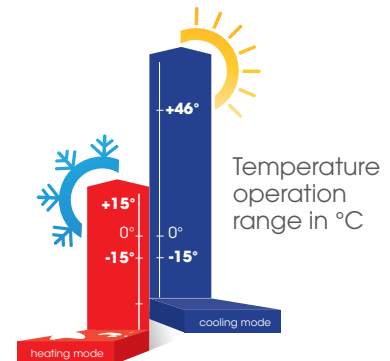

## CLASSIC LINEUP

Most light commercial applications are covered thanks to a comprehensive lineup from 2 to 6HP and 1-phase or 3-phase electrical connections.

Capacity	2HP	3HP	4HP	5HP	6HP	Compatible with
Digital Inverter Classic	✓ (1Ph only)*	✓ (1Ph only)	✓ (1Ph & 3Ph)	✓ (1Ph & 3Ph)	✓ (1Ph & 3Ph)	4-way cassette, standard duct and high wall.

\* Duct excl.

GP\_AT(8)  
**SUPER DIGITAL INVERTER**



The Toshiba Super Digital Inverter 1 series is leading energy efficiency, operating range and piping length, to offer the best solution for the majority of commercial projects and large residential applications.

**Top class efficiency**

- High efficiency SCOP of up to 5.51, thanks to Toshiba inverter technology.

**Wide adaptability**

- Operating temperature limits from -27°C (Heating) to +52°C (Cooling) allow the system to operate across a wide temperature range.
- Quiet operation.

**Flexible**

- Can be utilised for single, twin or triple indoor applications.

**Easy to maintain**

- Removable corner panels for easy access.
- Self-diagnosis function.



SCOP MAX



5.51

CAPACITY



5kW > 16kW

OPERATION



-27°C > +52°C

> Power consumption analysis embedded when SDI 1 series (1Ph only) is combined with the RBC-AMSU52-E

**Power consumption (Week)**

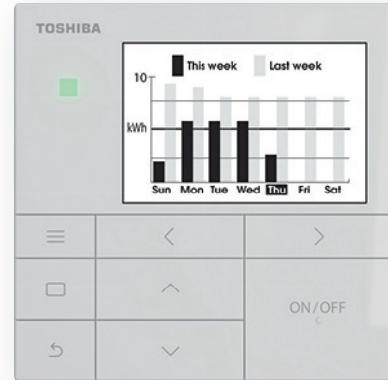

CASSETTE

RAV-HM\_UT-E/TR  
RAV-HM\_UTP-E/TR  
RAV-HM\_MUT-E/TR

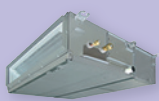

DUCTED

RAV-HM\_BTP-E/TR  
RAV-HM\_SDTY-E/TR



CEILING

RAV-HM\_CTP-E/TR



HIGH-WALL

RAV-HM\_KRTP-E/TR



FLOOR  
STANDING

RAV-HM\_FT-E/TR



OUTDOOR UNITS

RAV-GP561ATW-E/TR RAV-GP801ATW-E/TR RAV-GP1101AT(8)-E/TR  
RAV-GP1401AT(8)-E/TR  
RAV-GP1601AT8-E/TR

## SUPER DIGITAL INVERTER

### SUPER DIGITAL INVERTER Physical data outdoor - Single phase

Outdoor unit			RAV-GP561ATW-E/TR	RAV-GP801ATW-E/TR	RAV-GP1101AT-E/TR	RAV-GP1401AT-E1/TR1
			2 HP	3 HP	4 HP	5 HP
Air flow	m <sup>3</sup> /h - l/s		2250	3180	6960	6960
Sound pressure level	dB(A)	C	46	46	49	50
Sound power level	dB(A)	C	63	63	66	67
Operating range	°C	C	-15 / 52	-15 / 52	-15 / 52	-15 / 52
Sound pressure level	dB(A)	H	48	48	50	51
Sound power level	dB(A)	H	65	65	67	68
Operating range	°C	H	-27 / 15	-27 / 15	-27 / 15	-27 / 15
Dimensions (HxWxD)	mm		630 x 799 x 299	1050 x 1010 x 370	1550 x 1010 x 370	1550 x 1010 x 370
Weight	kg		45	74	104	104
Compressor type			DC Twin Rotary	DC Twin Rotary	DC Twin Rotary	DC Twin Rotary
Flare connections						
Gas	in		1/2	5/8	5/8	5/8
Liquid	in		1/4	3/8	3/8	3/8
Minimum pipe length	m		3	3	3	3
Maximum pipe length	m		50	50	75	75
Maximum height difference	m		30	30	30	30
Chargeless pipe length	m		20	30	30	30
R32 Refrigerant	kg/TCO <sub>2</sub> eq		1.35/0.91	1.9/1.28	3.1/2.09	3.1/2.09
Power supply	V-ph-Hz		220/240-1-50	220/240-1-50	220/240-1-50	220/240-1-50

### SUPER DIGITAL INVERTER Physical data outdoor - Three Phase

Outdoor unit			RAV-GP1101AT8-E/TR	RAV-GP1401AT8-E/TR	RAV-GP1601AT8-E/TR
			4 HP	5 HP	6 HP
Air Flow	m <sup>3</sup> /h - l/s		6060 - 1683	6180 - 1717	6180 - 1717
Sound pressure level	dB(A)	C	49	51	51
Sound power level	dB(A)	C	66	68	68
Operating range	°C	C	-15 / 46	-15 / 46	-15 / 46
Sound pressure level	dB(A)	H	50	52	53
Sound power level	dB(A)	H	67	69	70
Operating range	°C	H	-20 / 15	-20 / 15	-20 / 15
Dimensions (HxWxD)	mm		1340 x 900 x 320	1340 x 900 x 320	1340 x 900 x 320
Weight	kg		95	95	95
Compressor type			DC Twin Rotary	DC Twin Rotary	DC Twin Rotary
Flare connections					
Gas	in		5/8	5/8	5/8
Liquid	in		3/8	3/8	3/8
Minimum pipe length	m		3	3	3
Maximum pipe length	m		75	75	75
Maximum height difference	m		30	30	30
Chargeless pipe length	m		30	30	30
R32 Refrigerant	kg/TCO <sub>2</sub> eq		2.6/1.75	2.6/1.75	2.6/1.75
Power supply	V-ph-Hz		380/415-3N-50	380/415-3N-50	380/415-3N-50

C: cooling mode  
H: heating mode

# GM\_AT(8)W/P DIGITAL INVERTER



**> NEW**



Toshiba Digital Inverter wprowadza najnowocześniejszą technologię inwerterową do sektora komercyjnego i oferuje znaczne korzyści w zakresie wydajności, oszczędności energii, zoptymalizowanego sterowania i niższego poziomu czynnika chłodniczego. Unikalne funkcje są również proponowane instalatorom, aby zaoszczędzić czas na etapie instalacji, uruchomienia i konserwacji.

### Kompaktość

- Kompaktowa obudowa z jednym wentylatorem, łatwa w obsłudze i instalacji.

### Szerokie możliwości adaptacji

- Kompatybilny z 8 typami jednostek wewnętrznych: 4-kierunkowe kasetonowe, standardowe kanałowe, ściennie, sufitowe i stojące.
- Dostępne zarówno w wersji 1-fazowej, jak i 3-fazowej z możliwością podłączenia do dowolnego źródła zasilania.
- Długość przewodów do 50 m i różnica wysokości do 30 m zapewniają maksymalny zasięg projektu.

### Wydajność i zrównoważony rozwój

- Wydajność energetyczna na poziomie A++ dzięki sprężarce Twin Rotary
- Mniej niż 2,4 kg czynnika chłodniczego R32 przed napełnieniem, aby zoptymalizować ślad węglowy.

MAX SCOP



4.73  
A++

WYDAJNOŚĆ



2.5kW > 16kW

ZAKRES PRACY



-15°C > +46°C

Korzystaj z nowych, przyszłościowych funkcji, aby zachować pełną kontrolę nad systemami.

- > 3-stopniowy tryb nocny
- > Odszranianie
- > Ogranicznik wentylatora
- > Szacowanie ciśnienia Kontrola
- > szczelności układu chłodniczego



JEDNOSTKI ZEWNĘTRZNE

RAV-GM302ATP-E RAV-GM802ATW-E/TR RAV-GM1102AT(8)W-E/TR  
RAV-GM402ATP-E RAV-GM902ATW-E/TR RAV-GM1402AT(8)W-E/TR  
RAV-GM562ATP-E/TR RAV-GM1602AT(8)W-E/TR

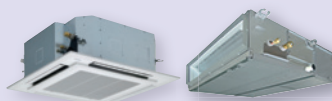

KASETY

KANAŁY



PODSUFITOWE

ŚCIENNE



STOJĄCE

RAV-HM\_UTP-E/TR RAV-HM\_BTP-E/TR RAV-HM\_CTP-E/TR RAV-HM\_KRTP-E/TR RAV-HM\_FT-E/TR  
RAV-HM\_MUT-E/TR RAV-HM\_SDTY-E/TR  
RAV-HM\_U1TP-E/TR



## DIGITAL INVERTER

DIGITAL INVERTER		Dane fizyczne na zewnątrz - 1-fazowe								DANE WSTĘPNE	
Jednostki zewnętrzne	RAV-	GM302ATP-E 1 HP	GM402ATP-E 1.5 HP	GM562ATP-E/TR 2 HP	GM802ATW-E/TR 3 HP	GM902ATW-E/TR 3.5 HP	GM1102ATW-E/TR 4 HP	GM1402ATW-E/TR 5 HP	GM1602ATW-E/TR 6 HP		
Przepływ powietrza	m <sup>3</sup> /h - l/s	1800 - 500	2200 - 611	2400 - 667	2808 - 780	2808 - 780	4950 - 1375	4950 - 1375	4950 - 1375		
Poziom ciśnienia akustycznego	dB(A) C	46	49	46	50	52	53	56	57		
Moc akustyczna	dB(A) C	61	64	63	68	68	70	73	74		
Zakres pracy	°C C	-15 / 46	-15 / 46	-15 / 46	-15 / 46	-15 / 46	-15 / 46	-15 / 46	-15 / 46		
Poziom ciśnienia akustycznego	dB(A) H	47	50	48	52	55	56	56	56		
Moc akustyczna	dB(A) H	62	65	65	71	71	73	74	74		
Zakres pracy	°C H	-15 / 15	-15 / 15	-15 / 15	-15 / 15	-15 / 15	-15 / 15	-15 / 15	-15 / 15		
Wymiary (WxSxG)	mm	550 x 780 x 290	550 x 780 x 290	550 x 780 x 290	630 x 799 x 299	630 x 799 x 299	1050 x 1010 x 370	1050 x 1010 x 370	1050 x 1010 x 370		
Waga	kg	29	34	40	47	47	85	85	88		
Typ sprężarki		DC Rotary	DC Twin Rotary	DC Twin Rotary	DC Twin Rotary	DC Twin Rotary	DC Twin Rotary	DC Twin Rotary	DC Twin Rotary		
Połączenia kielichowe											
Gaz	in	3/8	1/2	1/2	5/8	5/8	5/8	5/8	5/8		
Ciecz	in	1/4	1/4	1/4	3/8	3/8	3/8	3/8	3/8		
Minimalna długość rury	m	2	2	5	5	5	5	5	5		
Maksymalna długość rury	m	20	20	30	50	50	50	50	50		
Maksymalna różnica poziomów	m	10	10	30	30	30	30	30	30		
Długość rury bez ładunku	m	15	15	20	20	20	30	30	30		
Czynnik	Type/kg/ TeqCO <sub>2</sub>	R32 / 0.6 / 0.4	R32 / 0.9 / 0.6	R32 / 0.9 / 0.6	R32 / 1.9 / 1.28	R32 / 1.9 / 1.28	R32 / 2.4 / 1.62	R32 / 2.4 / 1.62	R32 / 2.4 / 1.62		
Zasilanie	V-ph-Hz	220/240-1-50, 220-1-60	220/240-1-50, 220-1-60	220/240-1-50, 220-1-60	220/240-1-50	220/240-1-50	220/240-1-50	220/240-1-50	220/240-1-50		

DIGITAL INVERTER		Dane fizyczne na zewnątrz - 3-fazowe			DANE WSTĘPNE		
Jednostki zewnętrzne		RAV-GM1102AT8W-E/TR 4 HP	RAV-GM1402AT8W-E/TR 5 HP	RAV-GM1602AT8W-E/TR 6 HP			
Przepływ powietrza	m <sup>3</sup> /h - l/s	4950 - 1375	4950 - 1375	4950 - 1375			
Poziom ciśnienia akustycznego	dB(A) C	53	56	57			
Moc akustyczna	dB(A) C	70	73	74			
Zakres pracy	°C C	-15 / 46	-15 / 46	-15 / 46			
Poziom ciśnienia akustycznego	dB(A) H	56	56	56			
Moc akustyczna	dB(A) H	73	74	74			
Zakres pracy	°C H	-15 / 15	-15 / 15	-15 / 15			
Wymiary (WxSxG)	mm	1050 x 1010 x 370	1050 x 1010 x 370	1050 x 1010 x 370			
Waga	kg	85	85	85			
Typ sprężarki		DC Twin Rotary	DC Twin Rotary	DC Twin Rotary			
Połączenia kielichowe							
Gaz	in	5/8	5/8	5/8			
Ciecz	in	3/8	3/8	3/8			
Minimalna długość rury	m	5	5	5			
Maksymalna długość rury	m	50	50	50			
Maksymalna różnica poziomów	m	30	30	30			
Długość rury bez ładunku	m	30	30	30			
Czynnik	Type/kg/ TeqCO <sub>2</sub>	R32 / 2.4 / 1.62	R32 / 2.4 / 1.62	R32 / 2.4 / 1.62			
Zasilanie	V-ph-Hz	380/415-3-50	380/415-3-50	380/415-3-50			

C: tryn chłodzenia  
H: tryb ogrzewania

GM\_AT8  
**BIG DIGITAL INVERTER**



Big DI combines very small footprint and all of Toshiba's expertise in terms of efficiency, reliability and connectivity to ensure energy savings as well as perfect comfort all year round.

**High efficiency and energy savings**

- Top class EER/COP thanks to exclusive Toshiba's inverter twin-rotary compressor.
- Wide capacity range down to 4.6kW to ensure continuous operation whatever the conditions and maximize efficiency.
- Compliance with ERP directive Lot21.

**Wide adaptability**

- Allows the connection of four indoor units (same type, same capacity).
- Compatible with a large choice of indoor units: 4-way cassette, 4-way compact cassette, slim duct, standard duct, high-wall & ceiling.

**Safe and reliable**

- Built-in leak detection system.



SCOP MAX



3.51

CAPACITY



19kW > 27kW

OPERATION



-27°C > +46°C

The installation can reach up to 100 m total piping length and 30 m in elevation without additional safety measures.

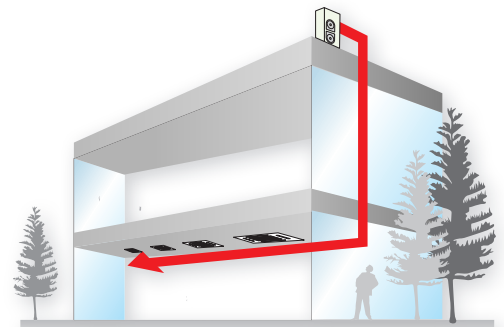

**INDOOR UNITS**

RAV-RM-DTP-E2/TR2



**OUTDOOR UNITS**

RAV-GM2241 AT8-E1/TR1  
RAV-GM2801 AT8-E1/TR1

## BIG DIGITAL INVERTER

### BIG DIGITAL INVERTER Physical data outdoor - 3Ph

Outdoor unit			RAV-GM2241AT8-E1/TR1 8 HP	RAV-GM2801AT8-E1/TR1 10 HP
Air Flow	m <sup>3</sup> /h - l/s		9150 - 2541	10890 - 3025
Sound pressure level	dB(A)	C	58	61
Sound power level	dB(A)	C	76	78
Operating range	°C	C	-15 / 46	-15 / 46
Sound pressure level	dB(A)	H	60	63
Sound power level	dB(A)	H	76	80
Operating range	°C	H	-27 / 15	-27 / 15
Dimensions (HxWxD)	mm		1550 x 1010 x 370	1550 x 1010 x 370
Weight	kg		142	142
Compressor type			DC Twin Rotary	DC Twin Rotary
Flare connections				
Gas	in		1 1/8	1 1/8
Liquid	in		1/2	1/2
Minimum pipe length	m		5	5
Maximum pipe length	m		100	100
Maximum height difference	m		30	30
Chargeless pipe length	m		30	30
R32 refrigerant charge	kg/ TCO <sub>2</sub> eq		5/10.44	5/10.44
Power supply	V-ph-Hz		380/415-3N-50	380/415-3N-50

C: cooling mode  
H: heating mode

RAV-GM2241AT8J-E	Heavy Corrosion Protection
RAV-GM2801AT8J-E	Heavy Corrosion Protection



# GV\_AT(8)P DIGITAL INVERTER CLASSIC



Digital Inverter Classic korzystając z wiedzy i doświadczenia firmy Toshiba, oferuje wydajne rozwiązania chłodzenia i ogrzewania dla sektora komercyjnego. Korzystaj z licznych zalet w zakresie oszczędności energii, zoptymalizowanego sterowania, niższego poziomu czynnika chłodniczego i kompaktowych rozmiarów.

### Kompaktość

- Pełna gama jednostek zewnętrznych z jednym wentylatorem zapewniająca wysoką elastyczność sytuowania.

### Szerokie możliwości adaptacji

- Kompatybilny z 3 typami jednostek wewnętrznych: 4-kierunkowe kasetonowe, standardowe kanałowe oraz ściennie.
- Dostępne zarówno w wersji 1Ph, jak i 3Ph, z możliwością podłączenia do dowolnego źródła zasilania od modelu 4HP.

### Wydajny i przyjazny dla środowiska

- Sprężarka Toshiba i falownik Toshiba zapewniają wysoką wydajność pracy.
- Zoptymalizowany dla czynnika chłodniczego R32.

MAX SCOP

4.20  
A++

WYDAJNOŚĆ



5.3 kW &gt; 16kW

ZAKRES PRACY



-15°C &gt; +46°C

Najnowocześniejsza sprężarka Toshiba jest wyposażona w potężny wirnik magnetyczny o dużej powierzchni, co zwiększa wydajność i zmniejsza hałas podczas pracy.

- > EFEKTYWNOŚĆ
- > NIEZAWODNOŚĆ
- > 100% TOSHIBA



JEDNOSTKI ZEWNĘTRZNE

RAV-GV561ATP-E/TR  
RAV-GV801ATP-E/TR

RAV-GV1101ATP-E/TR

RAV-GV1101AT8P-E/TR  
RAV-GV1401AT(8)P-E/TR

RAV-GV1601AT(8)P-E/TR



KASETA

RAV-HM\_UTP-E/TR

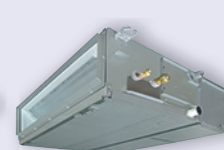

KANAŁY

RAV-HM\_BTP-E/TR

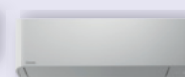

ŚCIENNE

RAV-HM\_KRTP-E/TR

**DIGITAL INVERTER CLASSIC**
**DIGITAL INVERTER CLASSIC Dane fizyczne na zewnątrz - 1-fazowe**

Jednostki zewnętrzne			RAV-GV561ATP-E 2 HP	RAV-GV801ATP-E 3 HP	RAV-GV1101ATP-E 4 HP	RAV-GV1401ATP-E 5 HP	RAV-GV1601ATP-E 6 HP
Przepływ powietrza	m <sup>3</sup> /h - l/s		2350 - 653	2700 - 750	2900 - 800	3500 - 972	5000 - 1389
Poziom ciśnienia akustycznego	dB(A)	C	46	48	51	53	57
Moc akustyczna	dB(A)	C	63	65	68	70	74
Zakres pracy	°C	C	-15 / 46	-15 / 46	-15 / 46	-15 / 46	-15 / 46
Poziom ciśnienia akustycznego	dB(A)	H	48	52	53	57	57
Moc akustyczna	dB(A)	H	65	69	70	74	74
Zakres pracy	°C	H	-15 / 15	-15 / 15	-15 / 15	-15 / 15	-15 / 15
Wymiary (WxSxG)	mm		550 x 780 x 290	550 x 780 x 290	630 x 800 x 300	710 x 900 x 320	890 x 900 x 320
Waga	kg		36	39	45	57	64
Typ sprężarki			DC Twin Rotary	DC Twin Rotary	DC Twin Rotary	DC Twin Rotary	DC Twin Rotary
Połączenia kielichowe							
Gaz	in		1/2	5/8	5/8	5/8	5/8
Ciecz	in		1/4	3/8	3/8	3/8	3/8
Minimalna długość rury	m		5	5	5	5	5
Maksymalna długość rury	m		30	30	30	30	30
Maksymalna różnica poziomów	m		20	20	30	30	30
Długość rury bez ładunku	m		20	20	30	30	30
Czynnik	Type/kg/TeqCO2		R32 / 0.9 / 0.6	R32 / 1.4 / 0.9	R32 / 1.9 / 1.3	R32 / 1.9 / 1.3	R32 / 2.2 / 1.5
Zasilanie	V-ph-Hz		220/240-1-50	220/240-1-50	220/240-1-50	220/240-1-50	220/240-1-50

**DIGITAL INVERTER CLASSIC Dane fizyczne na zewnątrz - 3-fazowe**

Outdoor unit			RAV-GV1101AT8P-E 4 HP	RAV-GV1401AT8P-E 5 HP	RAV-GV1601AT8P-E 6 HP
Przepływ powietrza	m <sup>3</sup> /h - l/s		3500 - 972	4200 - 1167	5000 - 1389
Poziom ciśnienia akustycznego	dB(A)	C	52	56	58
Moc akustyczna	dB(A)	C	69	73	75
Zakres pracy	°C	C	-15 / 46	-15 / 46	-15 / 46
Poziom ciśnienia akustycznego	dB(A)	H	58	60	60
Moc akustyczna	dB(A)	H	75	77	77
Zakres pracy	°C	H	-15 / 15	-15 / 15	-15 / 15
Wymiary (WxSxG)	mm		710 x 900 x 320	710 x 900 x 320	890 x 900 x 320
Waga	kg		60	60	63
Typ sprężarki			DC Twin Rotary	DC Twin Rotary	DC Twin Rotary
Połączenia kielichowe					
Gaz	in		5/8	5/8	5/8
Ciecz	in		3/8	3/8	3/8
Minimalna długość rury	m		5	5	5
Maksymalna długość rury	m		30	30	30
Maksymalna różnica poziomów	m		30	30	30
Długość rury bez ładunku	m		30	30	30
Czynnik	Type/kg/TeqCO2		R32 / 1.9 / 1.3	R32 / 1.9 / 1.3	R32 / 2.1 / 1.4
Zasilanie	V-ph-Hz		380/415-3-50	380/415-3-50	380/415-3-50

C: tryb chłodzenia  
H: tryb ogrzewania

HM\_UT  
4-WAY SMART CASSETTE



Dedicated for commercial application, the Toshiba Smart Cassette is the perfect mix between comfort, elegance and efficiency.

**Efficiency**

- Top class SEER and SCOP, thanks to long slit heat exchanger with magic coil treatment, high efficiency fan motor and large opening air conditioning ventilation.
- Energy saving with the occupancy sensor which will automatically switch off the unit if nobody is in the room (TCB-SIR41U-E needed).

**Comfort**

- Unique flap design for optimal air distribution.
- Individual setting of louver position: 3 different swing modes: standard, diagonally, opposite or turn around.
- 5 fan steps to precisely control the air flow.

**Design**

- Simple & elegant design fits various rooms.

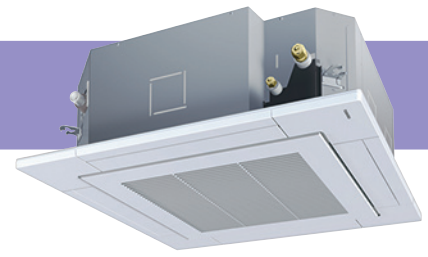

SCOP MAX



5.51

CAPACITY



5kW > 14kW

OPERATION



-27°C > +52°C

Louver position automatically adjusts to prevent cold draught being felt by users

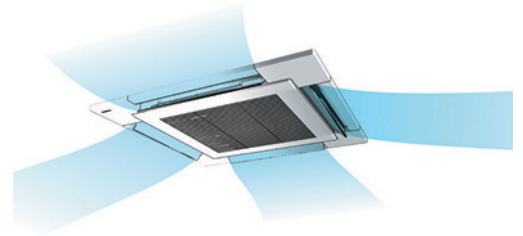

INDOOR UNITS

RAV-HM561UT-E/TR  
RAV-HM801UT-E/TR  
RAV-HM1101UT-E/TR  
RAV-HM1401UT-E/TR



OUTDOOR UNITS

RAV-GP561ATW-E/TR RAV-GP801ATW-E/TR  
RAV-GP1101AT-E1/TR1  
RAV-GP1401AT-E/TR



REMOTE CONTROLS

RBC-AX41U-E/TR  
RBC-AXU31-E/TR  
RBC-AWSU52-E  
RBC-AMSU52-E  
RBC-AMTU31-E  
RBC-ASCU11-E

**4-WAY SMART CASSETTE**

**4-WAY SMART CASSETTE Performance data with Super Digital Inverter Series 1**

Outdoor unit			RAV-GP561ATW-E/TR	RAV-GP801ATW-E/TR	RAV-GP1101AT-E/TR	RAV-GP1401AT-E1/TR1
Indoor unit (Cassette)			RAV-HM561UT-E/TR	RAV-HM801UT-E/TR	RAV-HM1101UT-E/TR	RAV-HM1401UT-E/TR
<b>Cooling capacity</b>	<b>kW</b>		<b>5.0</b>	<b>7.1</b>	<b>10.0</b>	<b>12.5</b>
Cooling range (min. - max.)	kW		1.2 - 5.6	1.9 - 8.0	3.1 - 12.0	3.1 - 14.0
Power input (min. - rated - max.)	kW	C	0.19 - 1.2 - 2.03	0.26 - 1.37 - 2.94	0.56 - 1.90 - 2.80	0.56 - 2.91 - 3.40
EER			4.17	5.18	5.26	4.30
SEER			8.17	9.72	9.25	8.87
Energy efficiency class		C	A++	A+++	A+++	-
Seasonal electricity consumption	kWh/a	C	214	256	378	845
<b>Heating capacity</b>	<b>kW</b>		<b>5.6</b>	<b>8.0</b>	<b>11.2</b>	<b>14.0</b>
Heating range (min. - max.)	kW		0.9 - 8.1	1.3 - 11.3	2.6 - 13.0	2.6 - 16.5
Power input (min. - rated - max.)	kW	H	0.16 - 1.29 - 2.75	0.20 - 1.45 - 3.15	0.41 - 2.18 - 2.98	0.41 - 3.04 - 4.18
COP	W/W		4.34	5.52	5.14	4.61
SCOP			5.02	5.54	5.03	5.00
Energy efficiency class		H	A++	A+++	A++	-
Seasonal electricity consumption	kWh/a	H	1058	1287	2557	2686

**4-WAY SMART CASSETTE Physical data indoor**

Indoor unit			RAV-HM561UT-E/TR	RAV-HM801UT-E/TR	RAV-HM1101UT-E/TR	RAV-HM1401UT-E/TR
Air flow (H/L)	m <sup>3</sup> /h - l/s		1050/750 - 291/208	1920/810 - 533/225	2250/1050 - 625/291	2250/1170 - 625/325
Sound pressure level (H-M-L)	dB(A)		32-29-26	42-35-27	48-40-31	48-41-33
Sound power level (H-M-L)	dB(A)		48-45-43	56-49-43	61-54-46	61-55-48
Dimensions (HxWxD)	mm		256 × 840 × 840	319 × 840 × 840	319 × 840 × 840	319 × 840 × 840
Weight	kg		20	25	25	25
Panel			RBC-U41PG(W)-E			
Panel dimensions (HxWxD)	mm		30×950×950	30×950×950	30×950×950	30×950×950
Panel weight	kg		5	5	5	5

C: cooling mode  
H: heating mode



HM\_UTP  
KASETA 4-DROGOWA



> NOWY CZARNY PANEL



4-drogowa kaseeta została zaprojektowana w celu zapewnienia równomiernej dystrybucji powietrza i całkowitego komfortu; jest to idealne rozwiązanie do małych zastosowań komercyjnych.

**Komfort**

- Dwie opcje kształtu żaluzji: prosta żaluzja i szeroka żaluzja; optymalna dystrybucja powietrza.
- Indywidualne ustawienie pozycji żaluzji: 3 różne tryby obrotu: standardowy, ukośny, przeciwny, odwrócony.
- Szeroki przepływ powietrza we wszystkich kierunkach.
- Opcjonalne filtry i oczyszczacze powietrza ePM2.5.

**Niezawodność**

- Funkcja samooczyszczania zapobiegająca powstawaniu pleśni.
- Wbudowana pompa spustowa wysokiego ciśnienia.

**Łatwa instalacja**

- Kompaktowa obudowa.
- Lekka jednostka zapewniająca łatwą i szybką instalację.

MAX SCOP



5.24  
A+++

WYDAJNOŚĆ



5kW > 16kW

ZAKRES PRACY



-27°C > +52°C

Opcjonalne zaawansowane rozwiązania filtracji powietrza wykorzystujące technologię jonizatora, aby pomóc w tworzeniu zdrowych przestrzeni roboczych.



JEDNOSTKI WEWNĘTRZNE

- RAV-HM561UTP-E/TR
- RAV-HM801UTP-E/TR
- RAV-HM901UTP-E/TR
- RAV-HM1101UTP-E/TR
- RAV-HM1401UTP-E/TR
- RAV-HM1601UTP-E/TR

SDI



JEDNOSTKI ZEWNĘTRZNE

- RAV-GP561ATW-E/TR
- RAV-GP801ATW-E/TR
- RAV-GP1101AT(8)-E/TR
- RAV-GP1401AT(8)-E(1)/TR(1)
- RAV-GP1601AT8-E/TR

DI



- RAV-GM562ATP-E/TR
- RAV-GM802ATW-E/TR
- RAV-GM902ATW-E/TR
- RAV-GM1102ATW(8)PE/TR
- RAV-GM1402ATW(8)P-E/TR
- RAV-GM1602ATW(8)P-E/TR

Dic



- RAV-GV561ATP-E/TR
- RAV-GV801ATP-E/TR
- RAV-GV1101AT(8)P-E/TR
- RAV-GV1401AT(8)P-E/TR
- RAV-GV1601AT(8)P-E/TR



STEROWNIKI

- RBC-U33P-E (white)
- RBC-U33PB-E (black)
- RBC-AXU31-E
- RBC-AWSU52-E
- RBC-AMSU52-E
- RBC-AMTU31-E
- RBC-ASCU11-E

## KASETA 4-DROGOWA

## KASETA 4-DROGOWA Dane dotyczące wydajności z Super Digital Inverter Series 1 1Ph &amp; 3h

Jednostka zewnętrzna	RAV-	GP561ATW-E/TR	GP801ATW-E/TR	GP1101AT-E/TR	GP1401AT-E1/TR1	GP1101AT8-E/TR	GP1401AT8-E/TR	GP1601AT8-E/TR
Jednostka wewnętrzna	RAV-	HM561UTP-E/TR	HM801UTP-E/TR	HM1101UTP-E/TR	HM1401UTP-E/TR	HM1101UTP-E/TR	HM1401UTP-E/TR	HM1601UTP-E/TR
<b>Wydajność chłodnicza</b>	<b>kW</b>	<b>5.0</b>	<b>7.1</b>	<b>10.0</b>	<b>10.0</b>	<b>12.5</b>	<b>12.5</b>	<b>14.0</b>
Zakres wydajności (min. - max.)	kW	1.2-5.6	1.9 - 8.0	3.1 - 12.0	2.6 - 12.0	3.1 - 14.0	2.6 - 14.0	2.6 - 16.0
Pobór mocy (min. - śr. - max.)	kW	C 0.19-1.22-1.97	0.26 - 1.58 - 3.15	0.56-1.90-2.80	0.66 -2.32- 3.60	0.53 - 3.16 - 3.55	0.66 - 3.42 - 4.40	0.66 - 4.34 - 5.70
EER		4.10	4.49	4.69	4.31	3.96	3.65	3.23
SEER		7.73	8.96	9.00	7.32	8.59	7.35	6.99
Klasa energetyczna	C	A++	A+++	A+++	A++	-	-	-
Sezonowe zużycie energii	kWh/a	C 226	277	389	478	874	1021	1201
<b>Wydajność grzewcza</b>	<b>kW</b>	<b>5.6</b>	<b>8.0</b>	<b>11.2</b>	<b>11.2</b>	<b>14.0</b>	<b>14.0</b>	<b>16.0</b>
Zakres wydajności (min. - max.)	kW	0.9-8.1	1.3 - 11.3	2.6 - 13.0	2.4 - 15.6	2.6 - 16.5	2.4 - 18.0	2.4 - 19.0
Pobór mocy (min. - śr. - max.)	kW	H 0.16 - 1.30 - 2.76	0.20 - 1.77 - 3.47	0.41 - 2.18 - 2.98	0.53 - 2.41 - 4.30	0.40 - 3.21 - 4.38	0.53 - 3.41 - 5.50	0.53 - 4.28 - 6.51
COP	W/W	4.31	4.52	4.79	4.65	4.36	4.11	3.74
SCOP		4.98	5.24	4.76	4.38	4.75	4.38	4.38
Klasa energetyczna	H	A++	A+++	A++	A+	-	-	-
Sezonowe zużycie energii	kWh/a	H 1069	1363	2706	3036	2832	3036	3036

## KASETA 4-DROGOWA Dane dotyczące wydajności z Digital Inverter Series 2 1Ph i 3Ph

## DANE WSTĘPNE

Jednostka zewnętrzna	RAV-	GM562ATP-E/TR	GM802ATW-E/TR	GM902ATW-E/TR	GM1102ATW-E/TR	GM1102AT8W-E/TR	GM1402ATW-E/TR	GM1402AT8W-E/TR	GM1602ATW-E/TR	GM1602AT8W-E/TR
Jednostka wewnętrzna	RAV-	HM561UTP-E/TR	HM801UTP-E/TR	HM901UTP-E/TR	HM1101UTP-E/TR	HM1101UTP-E/TR	HM1401UTP-E/TR	HM1401UTP-E/TR	HM1601UTP-E/TR	HM1601UTP-E/TR
<b>Wydajność chłodnicza</b>	<b>kW</b>	<b>5.0</b>	<b>6.7</b>	<b>8.0</b>	<b>9.5</b>	<b>9.5</b>	<b>12.1</b>	<b>12.1</b>	<b>14.0</b>	<b>14.0</b>
Zakres wydajności (min. - max.)	kW	1.5 - 5.6	1.9 - 8.0	1.9 - 8.8	3.0 - 11.2	3.0 - 11.2	3.0 - 13.2	3.0 - 13.2	3.0 - 15.0	3.0 - 15.0
Pobór mocy (min. - śr. - max.)	kW	C 0.26 -1.56 - 1.86	0.29 - 1.9 - 2.59	0.29 - 2.29 - 2.88	0.52 - 2.57 - 3.11	0.56 - 2.52 - 3.07	0.52 - 3.88 - 4.23	0.56 - 3.81 - 4.19	0.52 - 5.05 - 6.00	0.56 - 4.92 - 5.90
EER		3.21	3.52	3.50	3.70	3.76	3.12	3.17	2.77	2.84
SEER		6.84	7.50	7.50	7.50	7.15	7.30	6.91	6.60	6.53
Klasa energetyczna	C	A++	A++	A++	A++	A++	-	-	-	-
Sezonowe zużycie energii	kWh/a	C 256	313	373	443	465	994	1050	1272	1286
<b>Wydajność grzewcza</b>	<b>kW</b>	<b>5.3</b>	<b>7.7</b>	<b>8.6</b>	<b>11.2</b>	<b>11.2</b>	<b>13.0</b>	<b>13.0</b>	<b>16.0</b>	<b>16.0</b>
Zakres wydajności (min. - max.)	kW	1.5 - 6.3	1.6 - 9.0	1.6 - 9.9	3.0 - 13.0	3.0 - 13.0	3.0 - 16.0	3.0 - 16.0	3.0 - 17.0	3.0 - 18.0
Pobór mocy (min. - śr. - max.)	kW	H 0.26 -1.36 - 2.08	0.27 - 1.99 - 2.66	0.27 - 2.09 - 2.68	0.67 - 2.86 - 3.39	0.71 - 2.82 - 3.35	0.67 - 3.43 - 4.55	0.71 - 3.39 - 4.51	0.67 - 4.72 - 5.47	0.71 - 4.65 - 6.71
COP	W/W	3.90	3.87	4.12	3.92	3.97	3.79	3.83	3.39	3.44
SCOP		4.62	4.60	4.60	4.40	4.29	4.40	4.30	4.40	4.38
Klasa energetyczna	H	A++	A++	A++	A+	A+	-	-	-	-
Sezonowe zużycie energii	kWh/a	H 848	1552	1917	2544	2609	2544	2603	2542	2554

## KASETA 4-DROGOWA Dane dotyczące wydajności z Digital Inverter Classic Series 1 1Ph &amp; 3Ph

Jednostka zewnętrzna	RAV-	GV561ATP-E/TR	GV801ATP-E/TR	GV1101ATP-E/TR	GV1101AT8P-E/TR	GV1401ATP-E/TR	GV1401AT8P-E/TR	GV1601ATP-E/TR	GV1601AT8P-E/TR
Jednostka wewnętrzna	RAV-	HM561UTP-E/TR	HM801UTP-E/TR	HM1101UTP-E/TR	HM1101UTP-E/TR	HM1401UTP-E/TR	HM1401UTP-E/TR	HM1601UTP-E/TR	HM1601UTP-E/TR
<b>Wydajność chłodnicza</b>	<b>kW</b>	<b>5.0</b>	<b>6.7</b>	<b>9.5</b>	<b>9.5</b>	<b>11.5</b>	<b>12.1</b>	<b>13.0</b>	<b>13.0</b>
Zakres wydajności (min. - max.)	kW	1.5 - 5.6	1.5 - 8.0	3.0 - 11.2	3.0 - 11.2	3.0 - 12.0	3.0 - 14.0	3.0 - 14.0	3.0 - 15.0
Pobór mocy (min. - śr. - max.)	kW	C 1.60	2.20	3.15	3.10	4.60	4.80	5.40	5.40
EER	W/W	3.13	3.05	3.02	3.06	2.50	2.52	2.41	2.41
SEER		6.20	6.00	6.00	6.20	5.1	5.10	5.90	5.90
Klasa energetyczna	C	A++	A+	A+	A++	A	-	-	-
Sezonowe zużycie energii	kWh/a	C 282.00	391	554	537	789	1423	1322	1321
<b>Wydajność grzewcza</b>	<b>kW</b>	<b>5.3</b>	<b>7.0</b>	<b>10.0</b>	<b>10.0</b>	<b>11.9</b>	<b>12.3</b>	<b>13.5</b>	<b>13.5</b>
Zakres wydajności (min. - max.)	kW	1.5 - 6.3	1.5 - 9.0	3.0 - 13.0	3.0 - 13.0	3.0 - 16.0	3.0 - 16.0	3.0 - 18.0	3.0 - 18.0
Pobór mocy (min. - śr. - max.)	kW	H 1.40	1.90	3.10	3.00	3.80	4.10	3.9	3.9
COP	W/W	3.79	3.68	3.23	3.33	3.13	3.00	3.46	3.46
SCOP		4.20	4.15	4.00	4.10	3.90	3.90	4.20	4.20
Klasa energetyczna	H	A+	A+	A+	A+	A	-	-	-
Sezonowe zużycie energii	kWh/a	H 933	1619	2660	2596	2800	2800	2664	2665

## KASETA 4-DROGOWA Dane fizyczne wewnątrz pomieszczeń

Jednostka wewnętrzna	RAV-	HM561UTP-E/TR	HM801UTP-E/TR	HM901UTP-E/TR	HM1101UTP-E/TR	HM1401UTP-E/TR	HM1601UTP-E/TR
Przepływ powietrza (H/L)	m³/h - l/s	1050/780 - 292/217	1230/810 - 342/225	1600/900 - 444/250	2010/1170 - 558/325	2100/1230 - 583/342	2130/1260 - 592/350
Poziom ciśnienia akust. (min. - śr. - max.)	dB(A)	32-29-28	35-31-28	40-36-33	43-38-33	44-38-34	45-40-36
Poziom mocy akust. (min. - śr. - max.)	dB(A)	47-44-43	50-46-43	55-51-48	58-53-48	59-53-49	60-55-51
Wymiary (WxSxG)	mm	256 x 840 x 840	256 x 840 x 840	319 x 840 x 840	319 x 840 x 840	319 x 840 x 840	319 x 840 x 840
Waga	kg	20	20	24	24	24	24
Panel		RBC-U33P-E (white) / RBC-U33PB-E (black)					
Wymiary panelu	mm	30 x 950 x 950	30 x 950 x 950	30 x 950 x 950	30 x 950 x 950	30 x 950 x 950	30 x 950 x 950
Waga panelu	kg	4.2	4.2	4.2	4.2	4.2	4.2

C: tryb chłodzenia  
H: tryb ogrzewania

HM\_MUT  
**COMPACT 4-WAY CASSETTE**



The compact 4 way cassette has been especially designed for small commercial application where a compact efficient unit is needed.

**Design**

- Elegant and Flat appearance
- Fit within the T-bar of grid ceiling : 620mm X 620mm.

**Comfort**

- Individual setting of louver position: 3 different swing mode: standard, diagonally, opposite, turn around.
- 5 steps air flow.

**Easy to install**

- Compact and thin chassis with only 256mm height
- Built-in high-lift drain pump
- Light-weight unit, for easy and quick installation.

SCOP MAX



4.70  
A++

CAPACITY



2.5kW > 5.6kW

OPERATION



-27°C > +52°C

Occupancy sensor switches off automatically the unit if nobody is in the room to save energy.



**INDOOR UNITS**

RAV-HM301MUT-E  
 RAV-HM401MUT-E  
 RAV-HM561MUT-E/TR

**SDI**



**OUTDOOR UNITS**

RAV-GP561ATW-E/TR

**DI**



RAV-GM302ATP-E  
 RAV-GM402ATP-E  
 RAV-GM562ATP-E/TR



**REMOTE CONTROLS**

RBC-AXU31UM-E  
 RBC-AXU31-E

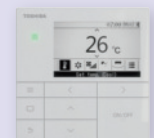

RBC-AWSU52-E  
 RBC-AMSU52-E  
 RBC-AMTU31-E  
 RBC-ASCU11-E

## COMPACT 4-WAY CASSETTE

### COMPACT 4-WAY CASSETTE Performance data with Super Digital Inverter Series 1

Outdoor unit	RAV-GP561ATW-E/TR	
Indoor unit (600X600 Cassette)	RAV-HM561MUT-E/TR	
<b>Cooling capacity</b>	<b>kW</b>	<b>5.0</b>
Cooling range (min. - max.)	kW	1.2 - 5.6
Power input (min. - rated - max.)	kW C	0.19 - 1.56 - 1.97
EER		3.21
SEER		6.27
Energy efficiency class	C	A++
Seasonal electricity consumption	kWh/a C	279
<b>Heating capacity</b>	<b>kW</b>	<b>5.6</b>
Heating range (min. - max.)	kW	0.9 - 7.0
Power input (min. - rated - max.)	kW H	0.16 - 1.60 - 2.36
COP	W/W	3.50
SCOP		4.32
Energy efficiency class	H	A+
Seasonal electricity consumption	kWh/a H	1231

### COMPACT 4-WAY CASSETTE Performance data with Digital Inverter Series 2

### PRELIMINARY DATA

Outdoor unit	RAV-GM302ATP-E		RAV-GM402ATP-E		RAV-GM562ATP-E/TR	
Indoor unit (600X600 Cassette)	RAV-HM301MUT-E		RAV-HM401MUT-E		RAV-HM561MUT-E/TR	
<b>Cooling capacity</b>	<b>kW</b>	<b>2.5</b>	<b>3.6</b>	<b>5.0</b>	<b>5.0</b>	<b>5.0</b>
Cooling range (min. - max.)	kW	0.9 - 3.0	0.9 - 4.0	1.5 - 5.6	1.5 - 5.6	1.5 - 5.6
Power input (min. - rated - max.)	kW C	0.18 - 0.59 - 0.82	0.18 - 0.90 - 2.00	0.30 - 1.64 - 1.86	0.30 - 1.64 - 1.86	0.30 - 1.64 - 1.86
EER	W/W	4.24	4.00	3.05	3.05	3.05
SEER		6.86	6.70	6.19	6.19	6.19
Energy efficiency class	C	A++	A++	A++	A++	A++
Seasonal electricity consumption	kWh/a C	128	188	283	283	283
<b>Heating capacity</b>	<b>kW</b>	<b>3.4</b>	<b>4.0</b>	<b>5.3</b>	<b>5.3</b>	<b>5.3</b>
Heating range (min. - max.)	kW	0.8 - 4.5	0.8 - 5.0	1.5 - 6.3	1.5 - 6.3	1.5 - 6.3
Power input (min. - rated - max.)	kW H	0.17 - 0.76 - 1.40	0.14 - 0.95 - 1.70	0.30 - 1.47 - 2.40	0.30 - 1.47 - 2.40	0.30 - 1.47 - 2.40
COP	W/W	4.47	4.21	3.61	3.61	3.61
SCOP		4.73	4.46	4.40	4.40	4.40
Energy efficiency class	H	A++	A+	A+	A+	A+
Seasonal electricity consumption	kWh/a H	681	848	891	891	891

### COMPACT 4-WAY CASSETTE Physical data indoor

Indoor unit	RAV-HM301MUT-E		RAV-HM401MUT-E		RAV-HM561MUT-E/TR	
Air flow (H/L)	m <sup>3</sup> /h - l/s	640/440 - 177/122	660/468 - 183/130	798/546 - 221/152	798/546 - 221/152	798/546 - 221/152
Sound pressure level (H-M-L)	dB(A)	38 - 36 - 30	41 - 36 - 32	44 - 39 - 35	44 - 39 - 35	44 - 39 - 35
Sound power level (H-M)	dB(A)	53 - 51 - 45	56 - 51 - 47	59 - 54 - 50	59 - 54 - 50	59 - 54 - 50
Dimensions (HxWxD)	mm	256 x 575 x 575	256 x 575 x 575	256 x 575 x 575	256 x 575 x 575	256 x 575 x 575
Weight	kg	15	15	15	15	15
Panel			RBC-UM21PG(W)-E			
Panel dimensions (HxWxD)	mm	12 x 620 x 620	12 x 620 x 620	12 x 620 x 620	12 x 620 x 620	12 x 620 x 620
Panel weight	kg	2.5	2.5	2.5	2.5	2.5

C: cooling mode  
H: heating mode  
H-M-L: High - Medium - Low speed



HM\_U1TP  
1-WAY CASSETTE

**> NEW**



The Toshiba innovative Slim-Line 1-Way Cassette is easy to install and suitable for small size offices such as the reception rooms of healthcare cabinets.

**Design**

- Elegant white panel design to match any type of interiors.

**Flexibility**

- 150mm chassis height adapted to ceilings with restricted void space
- Embedded drain pump for enhanced system reliability and simplified installation.

**Comfort**

- Low noise level down to 30 dB(A) for quiet operation
- 5-speed fan operation for perfect air flow management.

SCOP MAX



4.10  
A+

CAPACITY



2.5kW > 4kW

OPERATION



-15°C > +46°C

Advanced air filtration solutions available as an option to help create healthy working spaces.

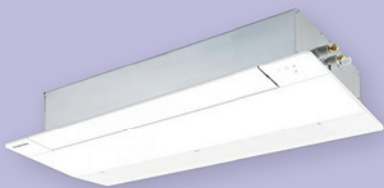
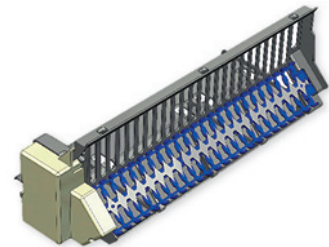

**INDOOR UNITS**

RAV-HM301U1TP-E  
RAV-HM401U1TP-E

**DI**



**OUTDOOR UNITS**

RAV-GM302ATP-E  
RAV-GM402ATP-E

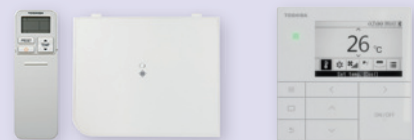

**REMOTE CONTROLS**

RBC-AX33UYP-E

RBC-AWSU52-E  
RBC-AMSU52-E  
RBC-AMTU31-E  
RBC-ASCU11-E

**COMPACT 1-WAY CASSETTE**
**COMPACT 1-WAY CASSETTE Performance data with Digital Inverter Series 2 1Ph**

Outdoor unit		RAV-GM302ATP-E	RAV-GM402ATP-E
Indoor unit (4-way Cassette)		RAV-HM301U1TP-E	RAV-HM401U1TP-E
<b>Cooling capacity</b>	<b>kW</b>	<b>2.50</b>	<b>3.60</b>
Cooling range (min. - max.)	kW	0.90 - 3.00	0.90 - 4.00
Power input (min. - rated - max.)	kW C	0.19 - 0.69 - 0.92	0.23 - 1.13 - 1.40
EER	W/W	3.62	3.19
SEER		6.20	6.00
Energy efficiency class	C	A++	A+
Seasonal electricity consumption	kWh/a C	141	210
<b>Heating capacity</b>	<b>kW</b>	<b>3.40</b>	<b>4.00</b>
Heating range (min. - max.)	kW	0.80 - 4.50	0.80 - 5.00
Power input (min. - rated - max.)	kW H	0.16 - 1.03 - 1.50	0.18 - 1.32 - 2.00
COP	W/W	3.30	3.03
SCOP		4.10	4.00
Energy efficiency class	H	A++	A+
Seasonal electricity consumption	kWh/a H	888	945

**COMPACT 1-WAY CASSETTE Physical data indoor**

Indoor unit		RAV-HM301U1TP-E	RAV-HM401U1TP-E
Air Flow (H/L)	m <sup>3</sup> /h - l/s	520/310 - 291/217	540/290 - 341/225
Sound pressure level (H-M-L)	dB(A)	39-35-30	40-36-30
Sound power level (H-M-L)	dB(A)	54-49-45	55-51-45
Dimensions (HxWxD)	mm	150 × 990 × 450	150 × 990 × 450
Weight	kg	13	13
Panel		RBC-UY32P-E	
Panel dimensions (HxWxD)	mm	30 × 1220 × 530	30 × 1220 × 530
Panel weight	kg	4.0	4.0

C: cooling mode  
H: heating mode

HM\_BTP  
**STANDARD DUCT**



Whatever the shape of the room, this flexible model ensures a uniform temperature and air distribution for optimal end user comfort.

**Adaptability**

- Up to 150Pa available pressure: thanks to DC fan motor.
- Flexible design, allows the inlet air configuration to be configured between the standard rear inlet design or as an alternative, from the underside of the unit. There is also a provision for a fresh air intake supply via a pre-punched knockout hole.
- Compact and thin chassis, measuring just 275mm in height.

**Easy to install**

- Built-in high-lift drain pump.
- PC board panel easily accessible from the side of the unit.
- Optional air discharge spigot.

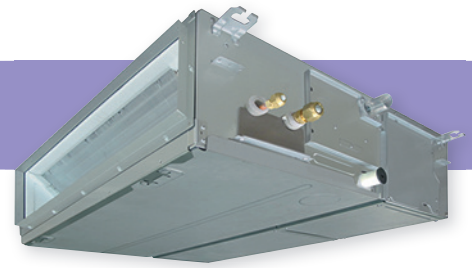

SCOP MAX



4.85  
A++

CAPACITY



5kW > 16kW

OPERATION



-27°C > +52°C

Simplify filter maintenance with live status to know exactly when they need to be cleaned!

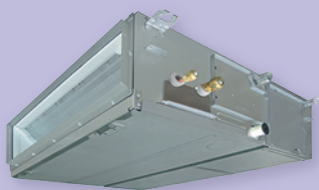
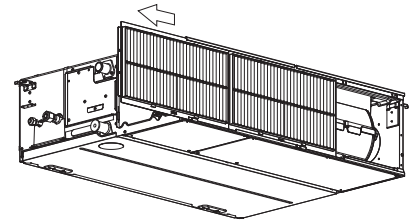

**INDOOR UNITS**

SDI



**OUTDOOR UNITS**

DI



Dlc



**REMOTE CONTROLS**

- RAV-HM561BTP-E/TR
- RAV-HM801BTP-E/TR
- RAV-HM901BTP-E/TR
- RAV-HM1101BTP-E/TR
- RAV-HM1401BTP-E/TR
- RAV-HM1601BTP-E/TR

- RAV-GP561ATW-E/TR
- RAV-GP801ATW-E/TR
- RAV-GP1101AT(8)-E/TR
- RAV-GP1401AT(8)-E(1)/TR(1)
- RAV-GP1601AT8-E/TR

- RAV-GM562ATP-E/TR
- RAV-GM802ATW-E/TR
- RAV-GM902ATW-E/TR
- RAV-GM1102AT(8)W-E/TR
- RAV-GM1402AT(8)W-E/TR
- RAV-GM1602AT(8)W-E/TR

- RAV-GV801ATP-E/TR
- RAV-GV1101AT(8)P-E/TR
- RAV-GV1401AT(8)P-E/TR
- RAV-GV1601AT(8)P-E/TR

- RBC-AXU31-E

- RBC-AWSU52-E
- RBC-AMTU31-E
- RBC-ASCU11-E

**STANDARD DUCT**

**STANDARD DUCT Performance data with Super Digital Inverter Series 1 1Ph & 3Ph**

Outdoor unit	RAV-	GP561ATW-E/TR	GP801ATW-E/TR	GP1101AT-E/TR	GP1401AT-E1/TR1	GP1101AT8-E/TR	GP1401AT8-E/TR	GP1601AT8-E/TR
Indoor unit	RAV-	HM561BTP-E/TR	HM801BTP-E/TR	HM1101BTP-E/TR	HM1401BTP-E/TR	HM1101BTP-E/TR	HM1401BTP-E/TR	HM1601BTP-E/TR
<b>Cooling capacity</b>	<b>kW</b>	<b>5.0</b>	<b>7.1</b>	<b>10.0</b>	<b>10.0</b>	<b>12.5</b>	<b>12.5</b>	<b>14.0</b>
Cooling range (min. - max.)	kW	1.2 - 5.6	1.9 - 8.0	3.1 - 12.0	2.6 - 12.0	3.1 - 14.0	2.6 - 14.0	2.6 - 16.0
Power input (min. - rated - max.)	kW C	0.19 - 1.52 - 1.99	0.26 - 1.63 - 3.20	0.65 - 2.40 - 3.63	0.66 - 2.58 - 4.01	0.65 - 3.57 - 3.97	0.66 - 3.81 - 4.89	0.66 - 4.49 - 6.50
EER		3.29	4.36	4.17	3.88	3.50	3.28	3.12
SEER		5.81	7.86	7.19	6.10	6.77	6.02	5.81
Energy efficiency class	C	A+	A++	A++	A+	-	-	-
Seasonal electricity consumption	kWh/a C	301	316	486	574	1107	1245	1444
<b>Heating capacity</b>	<b>kW</b>	<b>5.6</b>	<b>8.0</b>	<b>11.2</b>	<b>11.2</b>	<b>14.0</b>	<b>14.0</b>	<b>16.0</b>
Heating range (min. - max.)	kW	0.9-7.4	1.3 - 11.3	2.6 - 13.0	2.4 - 15.6	2.6 - 16.5	2.4 - 18.0	2.4 - 19.0
Power input (min. - rated - max.)	kW H	0.16 - 1.61 - 2.76	0.20 - 1.85 - 3.55	0.47 - 2.73 - 3.38	0.53 - 2.76 - 4.42	0.47 - 3.63 - 4.43	0.53 - 3.66 - 5.71	0.53 - 4.57 - 6.96
COP	W/W	3.48	4.32	4.10	4.06	3.86	3.83	3.50
SCOP		4.27	4.85	4.30	4.19	4.29	3.99	3.96
Energy efficiency class	H	A+	A++	A+	A+	-	-	-
Seasonal electricity consumption	kWh/a H	1245	1472	2997	3606	3133	4143	4238

**STANDARD DUCT Performance data with Digital Inverter Series 2 1Ph & 3Ph**

**PRELIMINARY DATA**

Outdoor unit	RAV-	GM562ATP-E/TR	GM802ATW-E/TR	GM902ATW-E/TR	GM1102ATW-E/TR	GM1102AT8W-E/TR	GM1402ATW-E/TR	GM1402AT8W-E/TR	GM1602ATW-E/TR	GM1602AT8W-E/TR
Indoor unit	RAV-	HM561BTP-E/TR	HM801BTP-E/TR	HM901BTP-E/TR	HM1101BTP-E/TR	HM1101BTP-E/TR	HM1401BTP-E/TR	HM1401BTP-E/TR	HM1601BTP-E/TR	HM1601BTP-E/TR
<b>Cooling capacity</b>	<b>kW</b>	<b>5.0</b>	<b>6.7</b>	<b>8.0</b>	<b>9.5</b>	<b>9.5</b>	<b>12.1</b>	<b>12.1</b>	<b>14.0</b>	<b>14.0</b>
Cooling range (min. - max.)	kW	1.5 - 5.6	1.9 - 8.0	1.9 - 8.8	3.0 - 11.2	3.0 - 11.2	3.0 - 13.2	3.0 - 13.2	3.0 - 15.0	3.0 - 15.0
Power input (min. - rated - max.)	kW C	0.31 - 1.83 - 2.05	0.33 - 2.02 - 2.77	0.33 - 2.39 - 2.97	0.64 - 2.60 - 3.21	0.68 - 2.56 - 3.17	0.64 - 4.01 - 4.52	0.68 - 3.94 - 4.48	0.64 - 5.26 - 6.00	0.68 - 5.14 - 5.90
EER		2.73	3.32	3.35	3.65	3.71	3.02	3.07	2.66	2.72
SEER		5.80	6.37	6.75	6.40	6.00	6.15	5.87	5.90	5.80
Energy efficiency class	C	A+	A++	A++	A++	A+	-	-	-	-
Seasonal electricity consumption	kWh/a C	302	368	415	519	554	1180	1236	1423	1448
<b>Heating capacity</b>	<b>kW</b>	<b>5.3</b>	<b>7.7</b>	<b>8.6</b>	<b>11.2</b>	<b>11.2</b>	<b>13.0</b>	<b>13.0</b>	<b>16.0</b>	<b>16.0</b>
Heating range (min. - max.)	kW	1.5 - 6.3	1.6 - 9.0	1.6 - 9.9	3.0 - 13.0	3.0 - 13.0	3.0 - 16.0	3.0 - 16.0	3.0 - 17.0	3.0 - 18.0
Power input (min. - rated - max.)	kW H	0.31 - 1.62 - 2.47	0.31 - 2.04 - 2.66	0.31 - 2.15 - 2.67	0.74 - 2.91 - 3.42	0.78 - 2.87 - 3.38	0.74 - 3.55 - 4.62	0.78 - 3.50 - 4.58	0.74 - 4.73 - 5.64	0.78 - 4.66 - 6.92
COP	W/W	3.27	3.77	4.00	3.85	3.90	3.66	3.71	3.38	3.43
SCOP		4.11	4.30	4.30	4.00	3.92	3.92	3.84	4.05	3.96
Energy efficiency class	H	A+	A+	A+	A+	A	-	-	-	-
Seasonal electricity consumption	kWh/a H	954	1660	2050	2937	2999	2998	3061	2901	2966

**STANDARD DUCT Performance data with Digital Inverter Classic Series 1 1Ph & 3Ph**

Outdoor unit	RAV-	GV801ATP-E/TR	GV1101ATP-E/TR	GV1101AT8P-E/TR	GV1401ATP-E/TR	GV1401AT8P-E/TR	GV1601ATP-E/TR	GV1601AT8P-E/TR
Indoor unit	RAV-	HM801BTP-E/TR	HM1101BTP-E/TR	HM1101BTP-E/TR	HM1401BTP-E/TR	HM1401BTP-E/TR	HM1601BTP-E/TR	HM1601BTP-E/TR
<b>Cooling capacity</b>	<b>kW</b>	<b>6.7</b>	<b>9.5</b>	<b>9.5</b>	<b>11.5</b>	<b>12.1</b>	<b>13.0</b>	<b>13.0</b>
Cooling range (min. - max.)	kW	1.5-8.0	3.0-11.2	3.0-11.2	3.0-12.0	3.0-14.0	3.0-14.0	3.0-15.0
Power input (min. - rated - max.)	kW C	2.30	3.17	3.06	4.70	4.90	5.40	5.40
EER		2.91	3.00	3.10	2.45	2.47	2.41	2.41
SEER		5.1	5.1	5.3	5.1	5.1	4.90	4.90
Energy efficiency class	C	A	A	A	A	0.0	0.0	0.0
Seasonal electricity consumption	kWh/a C	460	652	628	789	1423	1590	1591
<b>Heating capacity</b>	<b>kW</b>	<b>7.0</b>	<b>10.0</b>	<b>10.0</b>	<b>11.9</b>	<b>12.3</b>	<b>13.5</b>	<b>13.5</b>
Heating range (min. - max.)	kW	1.5-9.0	3.0-13.0	3.0-13.0	3.0-16.0	3.0-16.0	3.0-18.0	3.0-18.0
Power input (min. - rated - max.)	kW H	2.33	3.00	2.94	3.90	4.10	4.00	4.00
COP	W/W	3.0	3.3	3.40	3.05	3.00	3.38	3.38
SCOP		4.00	3.80	3.80	3.80	3.80	4.15	4.15
Energy efficiency class	H	A+	A	A	A	-	-	-
Seasonal electricity consumption	kWh/a H	1680	2800	2800	2874	2874	2700	2693

**STANDARD DUCT Physical data indoor**

Indoor unit	RAV-	HM561BTP-E/TR	HM801BTP-E/TR	HM901BTP-E/TR	HM1101BTP-E/TR	HM1401BTP-E/TR	HM1601BTP-E/TR
Air flow (H/L)	m³/h - l/s	800/480 - 222/133	1200/750 - 333/200	1700/1000 - 472/278	2100/1260 - 583/350	2100/1260 - 583/350	2100/1260 - 583/350
Sound pressure level (H-M-L)*	dB(A)	33-29-25	34-30-26	37-33-30	40-36-33	40-36-33	40-36-33
Sound power level (H-M-L)**	dB(A)	55-51-46	55-51-46	60-55-51	63-58-54	63-58-54	63-58-54
Dimensions (HxWxD)	mm	275 x 700 x 750	275 x 1000 x 750	275 x 1400 x 750	275 x 1400 x 750	275 x 1400 x 750	275 x 1400 x 750
Weight	kg	23	31	41	41	41	41
External static pressure (stand/upper limit)	Pa	30/150	30/150	40/150	40/150	50/150	50/150

C = cooling mode  
H = heating mode  
\*bottom air inlet  
\*\*back air inlet

▶ LIGHT COMMERCIAL



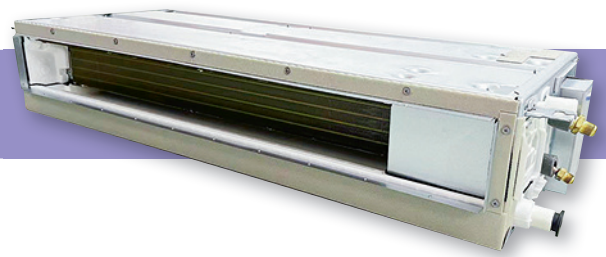

HM\_SDTY  
**SUPER SLIM DUCT**

**> NEW**



Whether installed in a ceiling void or in a suspended ceiling, the Super Slim Duct is easy to install and offers high performances as well as important energy savings.

**Flexibility**

- Whatever the capacity, the 210mm height and 450mm depth compact chassis is adapted to most projects
- Static pressure up to 50Pa set directly on the duct or by using a wired remote controller.

**Comfort**

- Noise level down to 26 dB(A) for quiet operation, especially well adapted for bedrooms
- 5-speed fan operation for perfect air flow adaptation.

**Easy installation**

- Built-in drain pump

SCOP MAX



4.35  
A+

CAPACITY



2.5kW > 8kW

OPERATION



-27°C > +52°C

Prefilter included  
Compatible with rear or underside  
air suction.

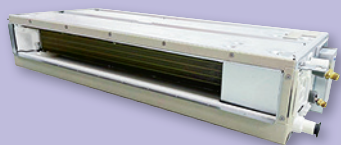
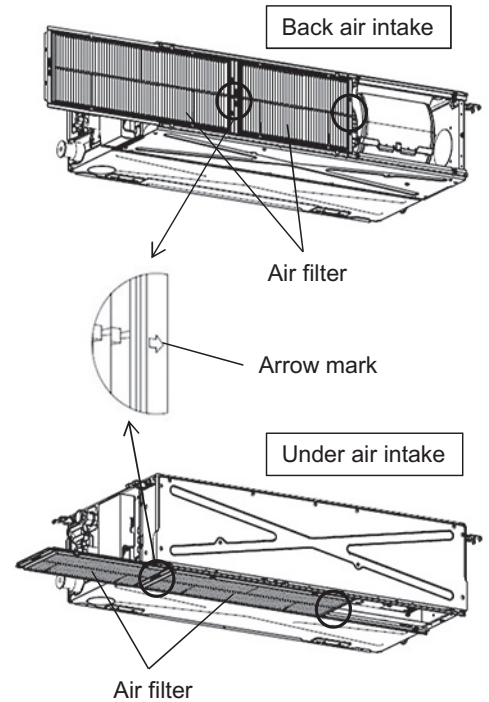

**INDOOR UNITS**

- RAV-HM301SDTY-E
- RAV-HM401SDTY-E
- RAV-HM561SDTY-E/TR
- RAV-HM801SDTY-E/TR

**SDI**



**OUTDOOR UNITS**

- RAV-GP561ATW-E/TR
- RAV-GP801ATW-E/TR

**DI**



- RAV-GM302ATP-E
- RAV-GM402ATP-E
- RAV-GM562ATP-E/TR
- RAV-GM802ATW-E/TR



**REMOTE CONTROLS**

- RBC-AXU31-E

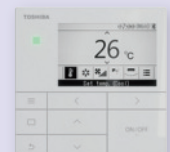

- RBC-AMSU52-E
- RBC-AWSU52-E
- RBC-AMTU31-E
- RBC-ASCU11-E

## SLIM DUCT - SERIES 1

### SLIM DUCT Performance data with Super Digital Inverter Series 1 1Ph

Outdoor unit		RAV-GP561ATW-E/TR		RAV-GP801ATW-E/TR	
Indoor unit (Slim duct)		RAV-HM561SDTY-E/TR		RAV-HM801SDTY-E/TR	
<b>Cooling capacity</b>	<b>kW</b>	<b>5.0</b>		<b>7.10</b>	
Cooling range (min. - max.)	kW	1.2 - 5.6		1.9 - 8.0	
Power input (min. - rated - max.)	kW	C	0.19 - 1.54 - 1.98	0.26 - 1.85 - 3.44	
EER	W/W	3.24		3.83	
SEER		6.15		6.68	
Energy efficiency class		C	A++	A++	
Seasonal electricity consumption	kWh/a	C	284	372	
<b>Heating capacity</b>	<b>kW</b>	<b>5.6</b>		<b>8.0</b>	
Heating range (min. - max.)	kW	0.9 - 7.0		1.3 - 11.3	
Power input (min. - rated - max.)	kW	H	0.16 - 1.57 - 2.66	0.20 - 2.12 - 3.52	
COP	W/W	3.56		3.77	
SCOP		4.23		4.27	
Energy efficiency class		H	A+	A+	
Seasonal electricity consumption	kWh/a	H	1256	1669	

### SLIM DUCT Performance data with Digital Inverter Series 2 1Ph

Outdoor unit		RAV-GM302ATP-E		RAV-GM402ATP-E		RAV-GM562ATP-E/TR		RAV-GM802ATW-E/TR	
Indoor unit (Slim duct)		RAV-HM301SDTY-E		RAV-HM401SDTY-E		RAV-HM561SDTY-E/TR		RAV-HM801SDTY-E/TR	
<b>Cooling capacity</b>	<b>kW</b>	<b>2.5</b>		<b>3.6</b>		<b>5.0</b>		<b>6.7</b>	
Cooling range (min. - max.)	kW	0.9 - 3.0		0.9 - 4.0		1.5 - 5.6		1.9 - 8.0	
Power input (min. - rated - max.)	kW	C	0.19 - 0.56 - 0.92	0.18 - 0.93 - 2.00		0.28 - 1.86 - 2.05		0.33 - 2.16 - 2.77	
EER	W/W	4.46		3.87		2.69		3.10	
SEER		6.41		6.03		5.80		5.63	
Energy efficiency class		C	A++	A+		A+		A+	
Seasonal electricity consumption	kWh/a	C	136	209		302		416	
<b>Heating capacity</b>	<b>kW</b>	<b>3.4</b>		<b>4.0</b>		<b>5.3</b>		<b>7.7</b>	
Heating range (min. - max.)	kW	0.8 - 4.5		0.8 - 5.0		1.5 - 6.3		1.6 - 9.0	
Power input (min. - rated - max.)	kW	H	0.17 - 0.86 - 1.40	0.17 - 0.97 - 1.70		0.22 - 1.50 - 2.40		0.31 - 2.24 - 2.66	
COP	W/W	3.95		4.12		3.53		3.44	
SCOP		4.35		4.00		4.00		4.00	
Energy efficiency class		H	A+	A+		A+		A+	
Seasonal electricity consumption	kWh/a	H	837	943		980		1783	

### SLIM DUCT Physical data indoor

Indoor unit		RAV-HM301SDTY-E		RAV-HM401SDTY-E		RAV-HM561SDTY-E/TR		RAV-HM801SDTY-E/TR	
Air Flow (H/L)	m <sup>3</sup> /h - l/s	570/420		600/440		780/650		1140/910	
Sound pressure level (H-M-L)*	dB(A)	32-29-26		33-30-27		34-32-29		37-34-32	
Sound power level (H-M-L)	dB(A)	54-50-46		54-50-46		56-54-51		61-58-55	
Dimensions (HxWxD)	mm	210 x 700 x 450		210 x 700 x 450		210 x 900 x 450		210 x 1100 x 450	
Weight	kg	15		15		19		22	
External static pressure standard (Upper-Lower)	Pa	50-10		50-10		50-10		50-10	

C: cooling mode  
H: heating mode  
\*bottom air inlet

RM\_DTP  
HIGH STATIC DUCT



Toshiba's high static pressure ducts are specially designed to air-condition large open spaces thanks to their impressive air flow characteristics.

**Comfort**

- 3-speed DC fan to provide correct air flow and maximise energy savings.
- Compatible with metal or textile ducts.

**Adaptability**

- Lightweight design for quick and easy installation.
- With 7-step settings, the static pressure of the duct can range from 52 to 250 Pa.
- Up to 5,600 m<sup>3</sup>/h air flow to efficiently blow the air into large rooms.

**Easy to install**

- Electronic components accessible from the outside of the unit.
- Air filter and drain pump are available as an option.



SCOP MAX



3.78

CAPACITY



19kW > 27kW

OPERATION



-27°C > +46°C

The DTP high static pressure duct is compatible with textile duct diffusion system to blow the air smoothly throughout the room.



INDOOR UNITS

RAV-RM2241 DTP-E2/TR2  
RAV-RM2801 DTP-E2/TR2



OUTDOOR UNITS

RAV-GM2241 AT8-E1/TR1  
RAV-GM2801 AT8-E1/TR1



REMOTE CONTROLS

RBC-AXU31-E

RBC-AWSU52-E  
RBC-AMSU52-E  
RBC-AMTU31E  
RBC-ASCU11-E

**HIGH STATIC DUCT**

**HIGH STATIC DUCT Performance data with Big DI Inverter Series 1 3Ph**

Outdoor unit	RAV-GM2241AT8-E1/TR1		RAV-GM2801AT8-E1/TR1
Indoor unit (High Static duct)	RAV-RM2241DTP-E2/TR2		RAV-RM2801DTP-E2/TR2
<b>Cooling capacity</b>	<b>kW</b>	<b>19.0</b>	<b>22.5</b>
Cooling range (min. - max.)	kW	4.6 - 22.4	4.6 - 27.0
Power input (min. - rated - max.)	kW C	1.27 - 5.35 - 9.05	1.27 - 6.76 - 11.87
EER	W/W	3.24	2.82
SEER		5.82	5.49
Energy efficiency class	C	-	-
Seasonal electricity consumption	kWh/a C	2468	2928
<b>Heating capacity</b>	<b>kW</b>	<b>22.4</b>	<b>27.0</b>
Heating range (min. - max.)	kW	4.6 - 25.0	4.6 - 31.5
Power input (min. - rated - max.)	kW H	1.27 - 5.71 - 10.15	1.27 - 7.52 - 13.83
COP	W/W	3.92	3.59
SCOP		3.78	3.69
Energy efficiency class	H	-	-
Seasonal electricity consumption	kWh/a H	7174	8136

**HIGH STATIC DUCT Physical data indoor**

Indoor unit	RAV-RM2241DTP-E2/TR2		RAV-RM2801DTP-E2/TR2
Air flow	m <sup>3</sup> /h - l/s	3800 - 1055	4800 - 1333
Sound pressure level (back)	dB(A)	44	46
Sound power level (back)	dB(A)	79	81
Dimensions (HxWxD)	mm	448 x 1400 x 900	448 x 1400 x 900
Weight	kg	97	97
Upper limit/middle/standard	Pa	250/150/50	250/150/50

C: cooling mode  
H: heating mode



HM\_CTP  
CEILING



The simple, yet elegant design helps to create a pleasant and relaxing environment, quickly conditioning the room air to the desired temperature.

**Comfort**

- Automatic louvre control for all year round comfort and efficiency.
- Low noise levels, thanks to high diameter fan and DC motor.

**Reliability**

- Self-cleaning function, enables the air flow to remain constant and fresh and reduces the frequency of service visits.

**Easy to install and to maintain**

- This design, represents the best possible solution, where there is a lack of space or absence of a ceiling void.

**Adaptability**

- Anti-bacterial drain point available as an option.
- Connecting kit available as an option for external I/O without local relay preparation.



SCOP MAX



5.05

CAPACITY



3.6kW > 16kW

OPERATION



-27°C > +52°C

The airflow angle is automatically set to the most suitable setting according to the cooling or heating needs.

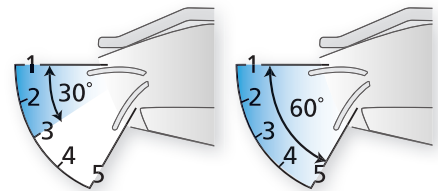

INDOOR UNITS

- RAV-HM401CTP-E
- RAV-HM561CTP-E/TR
- RAV-HM801CTP-E/TR
- RAV-HM901CTP-E/TR
- RAV-HM1101CTP-E/TR
- RAV-HM1401CTP-E/TR
- RAV-HM1601CTP-E/TR

SDI



OUTDOOR UNITS

- RAV-GP516ATW-E/TR
- RAV-GP801ATW-E/TR
- RAV-GP1101AT(8)-E/TR
- RAV-GP1401AT(8)-E(1)/TR(1)
- RAV-GP1601AT8-E/TR

DI



- RAV-GM402ATP-E
- RAV-GM562ATP-E/TR
- RAV-GM802ATW-E/TR
- RAV-GM902ATW-E/TR
- RAV-GM1102AT(8)W-E/TR
- RAV-GM1402AT(8)W-E/TR
- RAV-GM1602AT(8)W-E/TR



REMOTE CONTROLS

- RBC-AXU31C-E
- RBC-AXU31-E

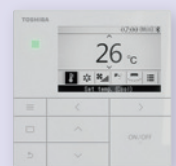

- RBC-AWSU52-E
- RBC-AMSU52-E
- RBC-AMTU31-E
- RBC-ASCU11-E

CEILING

**CEILING Performance data with Super Digital Inverter Series 1 1Ph**

Outdoor unit Indoor unit (Ceiling)	RAV- RAV-	GP561ATW-E HM561CTP-E	GP801ATW-E HM801CTP-E	GP1101AT-E HM1101CTP-E	GP1401AT-E1 HM1401CTP-E
<b>Cooling capacity</b>	<b>kW</b>	<b>5.0</b>	<b>7.1</b>	<b>10.0</b>	<b>12.5</b>
Cooling range (min. - max.)	kW	1.2 - 5.6	1.9 - 8.0	3.1 - 12.0	3.1 - 14.0
Power input	kW C	0.19 - 1.37 - 1.98	0.26 - 1.60 - 3.17	0.55 - 2.23 - 3.45	0.55 - 3.58 - 3.97
EER		3.65	4.44	4.48	3.49
SEER		6.93	8.35	8.58	7.99
Energy efficiency class	C	A++	A++	A+++	-
Seasonal electricity consumption	kWh/a C	253	298	408	939
<b>Heating capacity</b>	<b>kW</b>	<b>5.6</b>	<b>8.0</b>	<b>11.2</b>	<b>14.0</b>
Heating range (min. - max.)	kW	0.9 - 7.4	1.3 - 11.3	2.6 - 13.0	2.6 - 16.5
Power input (min. - rated - max.)	kW H	0.16 - 1.39 - 2.67	0.20 - 1.80 - 3.50	0.41 - 2.38 - 3.09	0.41 - 3.59 - 4.40
COP	W/W	4.03	4.44	4.71	3.90
SCOP		4.73	5.10	4.75	4.74
Energy efficiency class	H	A++	A++	A++	-
Seasonal electricity consumption	kWh/a H	1125	1401	2712	2838

**CEILING Performance data with Super Digital Inverter Series 1 3Ph**

Outdoor unit Indoor unit (Ceiling)	RAV- RAV-	GP1101AT8-E HM1101CTP-E	GP1401AT8-E HM1401CTP-E	GP1601AT8-E HM1601CTP-E
<b>Cooling capacity</b>	<b>kW</b>	<b>10.0</b>	<b>12.5</b>	<b>14.0</b>
Cooling range (min. - max.)	kW	2.6 - 12.0	2.6 - 14.0	2.6 - 16.0
Power input	kW C	0.66 - 2.56 - 3.81	0.66 - 3.68 - 4.85	0.66 - 4.60 - 6.33
EER		3.91	3.40	3.04
SEER		6.80	6.60	6.24
Energy efficiency class	C	A++	-	-
Seasonal electricity consumption	kWh/a C	515	1137	1347
<b>Heating capacity</b>	<b>kW</b>	<b>11.2</b>	<b>14.0</b>	<b>16.0</b>
Heating range (min. - max.)	kW	2.4 - 14.0	2.4 - 18.0	2.4 - 19.0
Power input (min. - rated - max.)	kW H	0.53 - 2.51 - 4.26	0.53 - 3.48 - 5.95	0.53 - 4.30 - 6.96
COP	W/W	4.46	4.02	3.72
SCOP		4.23	4.22	4.21
Energy efficiency class	H	A+	-	-
Seasonal electricity consumption	kWh/a H	3842	3916	3988

**CEILING Performance data with Digital Inverter Series 2 1Ph & 3Ph**

PRELIMINARY DATA

Outdoor unit Indoor unit (Ceiling)	RAV- RAV-	GM402ATP-E HM401CTP-E	GM562ATP-E HM561CTP-E	GM802ATW-E HM801CTP-E	GM902ATW-E HM901CTP-E	GM1102ATW-E HM1101CTP-E	GM1102AT8W-E HM1101CTP-E	GM1402ATW-E HM1401CTP-E	GM1402AT8W-E HM1401CTP-E	GM1602ATW-E HM1601CTP-E	GM1602AT8W-E HM1601CTP-E
<b>Cooling capacity</b>	<b>kW</b>	<b>3.6</b>	<b>5.0</b>	<b>6.9</b>	<b>8.0</b>	<b>9.5</b>	<b>9.5</b>	<b>12.1</b>	<b>12.1</b>	<b>14.0</b>	<b>14.0</b>
Cooling range (min. - max.)	kW	0.9 - 4.0	1.5 - 5.6	1.9 - 8.0	1.9 - 8.8	3.0 - 11.2	3.0 - 11.2	3.0 - 13.2	3.0 - 13.2	3.0 - 15.0	3.0 - 15.0
Power input	kW C	0.18 - 0.83 - 2.00	0.29 - 1.61 - 1.95	0.30 - 2.06 - 2.66	0.30 - 2.38 - 2.75	0.58 - 2.59 - 3.29	0.62 - 2.55 - 3.25	0.58 - 4.01 - 4.39	0.62 - 3.94 - 4.35	0.58 - 5.04 - 6.12	0.62 - 4.94 - 6.02
EER	W/W	4.34	3.11	3.35	3.36	3.67	3.72	3.02	3.07	2.78	2.83
SEER		7.2	6.00	7.03	7.03	7.00	6.46	6.16	5.87	6.25	6.12
Energy efficiency class	C	A++	A+	A++	A++	A++	A++	-	-	-	-
Seasonal electricity consumption	kWh/a C	175	291	343	398	475	514	1178	1236	1344	1372
<b>Heating capacity</b>	<b>kW</b>	<b>4.0</b>	<b>5.3</b>	<b>7.7</b>	<b>8.6</b>	<b>11.2</b>	<b>11.2</b>	<b>13.0</b>	<b>13.0</b>	<b>16.0</b>	<b>16.0</b>
Heating range (min. - max.)	kW	0.8 - 5.0	1.5 - 6.3	1.6 - 9.0	1.6 - 9.9	3.0 - 13.0	3.0 - 13.0	3.0 - 16.0	3.0 - 16.0	3.0 - 17.0	3.0 - 18.0
Power input (min. - rated - max.)	kW H	0.14 - 0.78 - 1.70	0.29 - 1.36 - 2.40	0.29 - 1.99 - 2.57	0.29 - 2.15 - 2.62	0.66 - 2.86 - 3.49	0.70 - 2.83 - 3.45	0.66 - 3.48 - 4.61	0.70 - 3.43 - 4.57	0.66 - 4.75 - 5.78	0.70 - 4.68 - 7.09
COP	W/W	5.13	3.90	3.87	4.00	3.91	3.95	3.74	3.79	3.37	3.41
SCOP		5.13	4.34	4.48	4.60	4.30	4.29	4.28	4.20	4.30	4.22
Energy efficiency class	H	A+++	A+	A+	A++	A+	A+	-	-	-	-
Seasonal electricity consumption	kWh/a H	736	904	1593	1916	2603	2609	2615	2665	2603	2652

**CEILING Physical data indoor**

Indoor unit	RAV- RAV-	HM401CTP-E	HM561CTP-E	HM801CTP-E	HM901CTP-E	HM1101CTP-E	HM1401CTP-E	HM1601CTP-E
Air flow (H/L)	m <sup>3</sup> /h - l/s	900/540 - 250/150	900/540 - 250/150	1410/750 - 392/208	1600/900 - 444/250	1860/1020 - 517/283	2040/1200 - 567/333	2040/1200 - 567/333
Sound pressure level (H-M-L)	dB(A)	37-35-28	37-35-28	41-36-29	42-38-30	44-38-32	46-41-35	46-42-36
Sound power level (H)	dB(A)	52-50-43	52-50-43	56-51-44	57-53-45	59-53-47	61-56-50	61-57-51
Dimensions (HxWxD)	mm	235 x 950 x 690	235 x 950 x 690	235 x 1270 x 690	235 x 1586 x 690	235 x 1586 x 690	235 x 1586 x 690	235 x 1586 x 690
Weight	kg	23	23	29	37	37	37	37

C = cooling mode  
H = heating mode  
H-M-L = High - Medium - Low speed

↑ LIGHT COMMERCIAL



Kompaktowa, cicha i atrakcyjna konstrukcja, ta jednostka ścienna nadaje się do każdego rodzaju projektu w nowym budownictwie lub renowacji.

#### Komfort

- Automatyczny tryb żaluzji umożliwia optymalną i równomierną dystrybucję powietrza.

#### Kontrola

- Bezprzewodowy pilot zdalnego sterowania z zaprogramowanymi funkcjami dostępnymi za pomocą dedykowanych przycisków: tryb wysokiej mocy, tryb cichy, komfortowy tryb uśpiania, tryb ekologiczny.

#### Zdrowie

- Funkcja samooczyszczania zapobiegająca tworzeniu się pleśni na wymienniku ciepła.

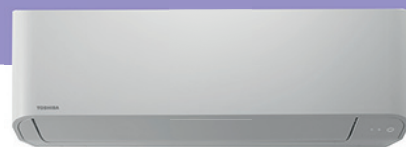

MAX SCOP



4.42  
A+

WYDAJNOŚĆ



2.5kW > 11.2kW

ZAKRES DZIAŁANIA



-20°C > +52°C

Funkcja komfortowego snu automatycznie dostosowuje temperaturę w pomieszczeniu i prędkość wentylatora.

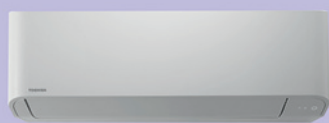

Jednostki wewnętrzne

RAV-HM301KRTP-E  
RAV-HM401KRTP-E  
RAV-HM561KRTP-E/TR  
RAV-HM801KRTP-E/TR  
RAV-HM901KRTP-E/TR  
RAV-HM1101KRTP-E/TR

SDI



Jednostki zewnętrzne

RAV-GP561ATW-E/TR  
RAV-GP801AT-E/TR  
RAV-GP1101AT(8)-E/TR

DI



RAV-GM302ATP-E  
RAV-GM402ATP-E  
RAV-GM562ATP-E/TR  
RAV-GM802ATW-E/TR  
RAV-GM902ATW-E/TR  
RAV-GM1102AT(8)W-E/TR

Dlc



RAV-GV561ATP-E/TR  
RAV-GV801ATP-E/TR  
RAV-GV1101AT(8)P-E/TR



Sterowniki

IR included

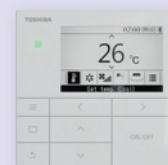

RBC-AWSU52-E  
RBC-AMSU52-E  
RBC-AMTU31-E  
RBC-ASCU11-E

## ŚCIENNE Dane dotyczące wydajności z Super Digital Inverter Series 1 1Ph &amp; 3Ph

Jednostka zewnętrzna	RAV-	GP561ATW-E/TR	GP801ATW-E/TR	GP1101ATP-E/TR	GP1101AT8-E/TR
Jednostka wewnętrzna	RAV-	HM561KRTP-E/TR	HM801KRTP-E/TR	GM1101KRTP-E/TR	GM1101KRTP-E/TR
<b>Wydajność chłodnicza</b>	<b>kW</b>	<b>5.0</b>	<b>7.1</b>	<b>10.0</b>	<b>10.0</b>
Zakres wydajności (min-max)	kW	1.2 - 5.6	1.9 - 8.0	3.1 - 12.0	2.6 - 12.0
Pobór mocy (min. - śr. - max.)	kW C	0.19 - 1.43 - 1.98	0.26 - 2.06 - 3.17	0.55-2.77-3.90	2.86
EER		3.50	3.45	3.61	3.50
SEER		7.84	7.56	7.36	6.53
Klasa energetyczna	C	A++	A++	A++	A++
Sezonowe zużycie energii	kWh/a C	223	329	475	536
<b>Wydajność grzewcza</b>	<b>kW</b>	<b>5.6</b>	<b>8.0</b>	<b>11.2</b>	<b>11.2</b>
Zakres wydajności (min-max)	kW	0.9 - 7.3	1.3 - 11.3	2.6 - 13.0	2.4 - 13.0
Wejście zasilania	kW H	0.16 - 1.39 - 2.67	0.20 - 2.25 - 3.50	0.52 - 3.13 - 4.40	3.25
COP	W/W	4.03	3.56	3.58	3.45
SCOP		4.19	4.16	4.42	4.22
Klasa energetyczna	H	A+	A+	A+	A+
Sezonowe zużycie energii	kWh/a H	1268	1717	2911	3591

## ŚCIENNE Dane dotyczące wydajności z Super Digital Inverter Series 2 1Ph &amp; 3Ph

## DANE WSTĘPNE

Jednostka zewnętrzna	RAV-	GM302ATP-E	GM402ATP-E	GM562ATP-E	GM802ATW-E	GM902ATW-E	GM1102ATW-E	GM1101AT8P-E
Jednostka wewnętrzna	RAV-	HM301KRTP-E	HM401KRTP-E	HM561KRTP-E	HM801KRTP-E	HM901KRTP-E	HM1101KRTP-E	HM1101KRTP-E
<b>Wydajność chłodnicza</b>	<b>kW</b>	<b>2.5</b>	<b>3.6</b>	<b>5.0</b>	<b>6.7</b>	<b>8.0</b>	<b>9.5</b>	<b>9.5</b>
Zakres wydajności (min-max)	kW	0.9 - 3.0	0.9 - 4.0	1.5 - 5.6	1.9 - 8.0	1.9 - 8.8	3.0 - 11.2	3.0 - 11.2
Pobór mocy (min. - śr. - max.)	kW C	0.17 - 0.61 - 0.86	0.18 - 1.13 - 2.00	0.30 - 1.66 - 1.86	0.31 - 2.06 - 2.86	0.31 - 2.67 - 3.16	0.63 - 2.96 - 3.95	0.67 - 2.95 - 3.91
EER	W/W	4.10	3.19	3.01	3.25	3.00	3.21	3.22
SEER		7.00	6.70	6.69	6.60	6.60	6.40	6.10
Klasa energetyczna	C	A++	A++	A++	A++	A++	A++	A++
Sezonowe zużycie energii	kWh/a C	125	188	262	355	424	519	545
<b>Wydajność grzewcza</b>	<b>kW</b>	<b>3.4</b>	<b>4.0</b>	<b>5.3</b>	<b>7.7</b>	<b>8.6</b>	<b>11.2</b>	<b>11.2</b>
Zakres wydajności (min-max)	kW	0.8 - 4.5	0.8 - 5.0	1.5 - 6.3	1.6 - 9.0	1.6 - 9.9	3.0 - 13.0	3.0 - 13.0
Wejście zasilania	kW H	0.17 - 0.85-1.40	0.14 - 1.12 - 1.70	0.30 - 1.55 - 2.40	0.38 - 2.30 - 3.04	0.38 - 2.61 - 3.27	0.73 - 3.44 - 4.33	0.77 - 3.38 - 4.29
COP	W/W	4.00	3.57	3.42	3.35	3.30	3.26	3.31
SCOP		4.12	4.24	4.02	4.05	4.10	4.20	4.20
Klasa energetyczna	H	A+	A+	A+	A+	A+	A+	A+
Sezonowe zużycie energii	kWh/a H	884	892	975	1762	2150	2665	2666

## ŚCIENNE Dane dotyczące wydajności z Digital Inverter Classic Series 1 1Ph &amp; 3Ph

Jednostka zewnętrzna	RAV-	GV561ATP-E/TR	GV801ATP-E/TR	GV1101ATP-E/TR	GV1101AT8P-E/TR
Jednostka wewnętrzna	RAV-	HM561KRTP-E/TR	HM801KRTP-E/TR	HM1101KRTP-E/TR	HM1101KRTP-E/TR
<b>Wydajność chłodnicza</b>	<b>kW</b>	<b>5.0</b>	<b>6.7</b>	<b>9.5</b>	<b>9.5</b>
Zakres wydajności (min-max)	kW	1.5 - 5.6	1.5 - 8.0	3.0 - 10.6	3.0 - 11.2
Pobór mocy (min. - śr. - max.)	kW C	1.45	2.20	3.80	3.40
EER		3.45	3.05	2.50	2.79
SEER		6.20	5.75	6.00	6.10
Klasa energetyczna	C	A++	A+	A+	A++
Sezonowe zużycie energii	kWh/a C	282	408	554	545
<b>Wydajność grzewcza</b>	<b>kW</b>	<b>5.3</b>	<b>7.0</b>	<b>10.0</b>	<b>10.0</b>
Zakres wydajności	kW	1.5-6.3	1.5-9.0	3.0-13.0	3.0-13.0
Wejście zasilania	kW H	1.50	2.20	3.30	3.20
COO	W/W	3.53	3.18	3.03	3.13
SCOP		3.90	3.90	4.00	4.10
Klasa energetyczna	H	A	A	A+	A+
Sezonowe zużycie energii	kWh/a H	1005	1723	2666	2593

## ŚCIENNE Dane fizyczne wewnątrz pomieszczeń

Indoor unit	RAV-	HM301KRTP-E/TR	HM401KRTP-E/TR	HM561KRTP-E/TR	HM801KRTP-E/TR	HM901KRTP-E/TR	HM1101KRTP-E/TR
Przepływ powietrza (H/L)	m³/h - l/s	C 670/450 - 186/125	700/450 - 194/125	960/680 - 267/189	1040/680 - 289/189	1180/ 680 - 328/189	1610/1180 - 447/328
Poziom ciśnienia akustycznego (H-M-L)	dB(A)	C 40-34-29	41-36-30	42-39-35	45-41-35	47-41-35	49-45-41
Poziom mocy akustycznej (H-M-L)	dB(A)	C 55-49-44	56-51-45	57-54-50	60-56-50	62-56-50	64-60-56
Wymiary (WxSxG)	mm	293 x 798 x 230	293 x 798 x 230	320 x 1050 x 250	320 x 1050 x 250	320 x 1050 x 250	350 x 1200 x 280
Waga	kg	10	10	14	14	14	19

C: Tryb chłodzenia  
H: Tryb ogrzewania



HM\_FT  
FLOOR STANDING



Toshiba floor standing unit combines important air flow, wide air diffusion and simplified installation to cool and heat large rooms.

**Wide adaptability**

- Broad capacity lineup from 2 to 6HP.
- Connectable in monosplit or twin mode.

**Comfort**

- Wide air flow to cool and heat large areas.
- Horizontal and vertical louvers for optimum air distribution.

**Easy to install**

- Directly positioned on the floor to simplify installation.
- Plug and play product with embedded link detector.



SCOP MAX



4.40  
A+

CAPACITY



5kW > 16kW

OPERATION



-27°C > +52°C

Embedded leak detector linked to safety ventilation to facilitate the integration of the product in every kind of projects.



INDOOR UNITS

- RAV-HM561FT-E/TR
- RAV-HM801FT-E/TR
- RAV-HM1101FT-E/TR
- RAV-HM1401FT-E/TR
- RAV-HM1601FT-E/TR

SDI



OUTDOOR UNITS

- RAV-GP561ATW-E/TR
- RAV-GP801ATW-E/TR
- RAV-GP1101AT(8)-E/TR
- RAV-GP1401AT(8)-E/TR
- RAV-GP1601AT8-E/TR

DI



- RAV-GM562ATP-E/TR
- RAV-GM802ATW-E/TR
- RAV-GM1102AT(8)W-E/TR
- RAV-GM1402AT(8)W-E/TR



REMOTE CONTROLLER

- RBC-AWSU52-E
- RBC-AMSU52-E
- RBC-AMTU31-E
- RBC-ASCU11-E

**FLOOR STANDING**

**FLOOR STANDING Performance data with Super Digital Inverter Series 1 1Ph**

Outdoor unit	RAV-GP561ATW-E/TR		RAV-GP801ATW-E/TR		RAV-GP1101AT-E/TR		RAV-GP1401AT-E/TR1	
Indoor unit (High-wall)	RAV-HM561FT-E/TR		RAV-HM801FT-E/TR		RAV-HM1101FT-E/TR		RAV-HM1401FT-E/TR	
<b>Cooling capacity</b>	<b>kW</b>	<b>5.0</b>		<b>7.1</b>		<b>10</b>		<b>12.3</b>
Cooling range (min. - max.)	kW	1.2 - 5.6		1.9 - 8.0		3.1 - 12.0		3.1 - 14.0
Power input	kW C	0.19 - 1.42 - 2.0		0.26 - 2.04 - 3.32		0.6 - 2.39 - 3.65		0.6 - 3.78 - 4.07
EER		3.51		3.48		4.18		3.25
SEER		5.87		6.43		6.99		6.49
Energy efficiency class	C	A+		A++		A++		-
Seasonal electricity consumption	kWh/a C	298		386		500		1137
<b>Heating capacity</b>	<b>kW</b>	<b>5.6</b>		<b>8.0</b>		<b>11.2</b>		<b>13.2</b>
Heating range (min. - max.)	kW	0.9 - 7.0		1.3 - 11.3		2.6 - 13.0		2.6 - 16.5
Power input (min. - rated - max.)	kW H	0.16 - 1.65 - 2.80		0.2 - 2.37 - 3.75		0.42 - 2.76 - 3.85		0.42 - 4.40 - 4.61
COP	W/W	3.39		3.38		4.06		3.00
SCOP		4.21		4.43		4.40		4.38
Energy efficiency class	H	A+		A+		A+		-
Seasonal electricity consumption	kWh/a H	1262		1610		2922		3062

**FLOOR STANDING Performance data with Super Digital Inverter Series 1 3Ph**

Outdoor unit	RAV-GP561ATW-E/TR		RAV-GP801ATW-E/TR		RAV-GP1101AT-E/TR		RAV-GP1101AT8-E/TR		RAV-GP1401AT-E/TR		RAV-GP1401AT8-E/TR		RAV-GP1601AT8-E/TR	
Indoor unit (High-wall)	RAV-HM561FT-E/TR		RAV-HM801FT-E/TR		RAV-HM1101FT-E/TR		RAV-HM1101FT-E/TR		RAV-HM1401FT-E/TR		RAV-HM1401FT-E/TR		RAV-HM1601FT-E/TR	
<b>Cooling capacity</b>	<b>kW</b>	<b>5.0</b>		<b>7.1</b>		<b>10</b>		<b>10</b>		<b>12.3</b>		<b>12.5</b>		<b>14.0</b>
Cooling range (min. - max.)	kW	1.2 - 5.6		1.9 - 8.0		3.1 - 12.0		2.6 - 12.0		3.1 - 14.0		2.6 - 14.0		2.6 - 16.0
Power input	kW C	0.19-1.42-2.0		0.26-2.04-3.32		0.6-2.39-3.65		0.66-2.46-4.1		0.6-3.78-4.07		0.66-3.61-4.91		0.66-4.39-6.5
EER	W/W	3.51		3.48		4.18		4.07		3.25		3.46		3.19
SEER		5.87		6.43		6.99		6.14		6.49		6.10		5.88
Energy efficiency class	C	A+		A++		A++		A++		-		-		-
Seasonal electricity consumption	kWh/a C	298		386		500		570		1137		1229		1428
<b>Heating capacity</b>	<b>kW</b>	<b>5.6</b>		<b>8.0</b>		<b>11.2</b>		<b>11.2</b>		<b>13.2</b>		<b>14.0</b>		<b>16.0</b>
Heating range (min. - max.)	kW	0.9 - 7.0		1.3 - 11.3		2.6 - 13.0		2.4 - 14.0		2.6 - 16.5		2.4 - 18.0		2.4 - 19.0
Power input (min. - rated - max.)	kW H	0.16-1.65-2.80		0.2-2.37-3.75		0.42-2.76-3.85		0.53-2.77-4.8		0.42-4.40-4.61		0.53-3.81-5.95		0.53-4.83-6.96
COP	W/W	3.39		3.38		4.06		4.04		3.00		3.67		3.31
SCOP		4.21		4.43		4.40		4.02		4.38		4.02		3.98
Energy efficiency class	H	A+		A+		A+		A+		-		-		-
Seasonal electricity consumption	kWh/a H	1262		1610		2922		3752		3062		4103		4212

**FLOOR STANDING Performance data with Digital Inverter Series 2 1Ph & 3Ph**

**PRELIMINARY DATA**

Outdoor unit	RAV-GM562ATP-E/TR		RAV-GM802ATW-E/TR		RAV-GM902ATW-E/TR		RAV-GM1102ATW-E/TR		RAV-GM1102AT8W-E/TR		RAV-GM1402ATW-E/TR		RAV-GM1402AT8W-E/TR		RAV-GM1602ATW-E/TR		RAV-GM1602AT8W-E/TR	
Indoor unit (High-wall)	RAV-HM561FT-E/TR		RAV-HM801FT-E/TR		RAV-HM901FT-E/TR		RAV-HM1101FT-E/TR		RAV-HM1101FT-E/TR		RAV-HM1401FT-E/TR		RAV-HM1401FT-E/TR		RAV-HM1601FT-E/TR		RAV-HM1601FT-E/TR	
<b>Cooling capacity</b>	<b>kW</b>	<b>5</b>		<b>6.7</b>		<b>8.0</b>		<b>9.5</b>		<b>9.5</b>		<b>12.1</b>		<b>12.1</b>		<b>14.0</b>		<b>14.0</b>
Cooling range (min. - max.)	kW	1.5 - 5.6		1.9 - 8.0		1.9 - 8.8		3.0 - 11.2		3.0 - 11.2		3.0 - 13.2		3.0 - 13.2		3.0 - 15.0		3.0 - 15.0
Power input	kW C	0.30-1.79-2.00		0.37 - 2.23 - 2.91		0.37 - 2.42 - 3.02		0.60 - 2.71 - 3.28		0.64 - 2.67 - 3.24		0.60 - 4.32 - 4.62		0.64 - 4.24 - 4.58		0.60 - 5.32 - 6.19		0.64 - 5.22 - 6.09
EER		2.79		3.01		3.30		3.50		3.55		2.80		2.85		2.63		2.68
SEER		5.86		5.53		6.24		6.22		5.88		5.53		5.35		5.20		5.15
Energy efficiency class	C	A+		A		A++		A++		A+		-		-		-		-
Seasonal electricity consumption	kWh/a C	299		424		449		534		565		1311		1355		1613		1630
<b>Heating capacity</b>	<b>kW</b>	<b>5.3</b>		<b>7.7</b>		<b>8.6</b>		<b>11.2</b>		<b>11.2</b>		<b>13.0</b>		<b>13.0</b>		<b>16.0</b>		<b>16.0</b>
Heating range (min. - max.)	kW	1.5 - 6.3		1.6 - 9.0		1.6 - 9.9		3.0 - 13.0		3.0 - 13.0		3.0 - 16.0		3.0 - 16.0		3.0 - 17.0		3.0 - 18.0
Power input (min. - rated - max.)	kW H	0.22-1.72-2.70		0.32 - 2.48 - 3.17		0.32 - 2.32 - 3.31		0.70 - 3.10 - 3.79		0.74 - 3.07 - 3.75		0.70 - 3.95 - 5.03		0.74 - 3.89 - 4.99		0.70 - 5.65 - 6.16		0.74 - 5.65 - 7.55
COP	W/W	3.08		3.11		3.70		3.61		3.64		3.29		3.34		2.83		2.83
SCOP		4.01		4.00		4.00		3.92		3.92		3.90		3.90		3.90		3.82
Energy efficiency class	H	A+		A+		A+		A		A		-		-		-		-
Seasonal electricity consumption	kWh/a H	976		1783		2203		2960		2960		2975		2975		2972		3035

**FLOOR STANDING Physical data indoor**

Indoor unit	RAV-HM561FT-E/TR		RAV-HM801FT-E/TR		RAV-HM1101FT-E/TR		RAV-HM1401FT-E/TR		RAV-HM1601FT-E/TR		
Air flow (H/L)	m³/h - l/s	820/600 - 228/167		930/640 - 258/178		1660/1170 - 461/325		1760/1350 - 489/375		1760/1350 - 489/375	
Sound pressure level (H-M-L)	dB(A)	C 46-42-38		50-45-41		51-46-41		53-48-45		53-48-45	
Sound power level (H-M-L)	dB(A)	C 60-56-52		64-60-54		65-61-55		67-62-59		67-62-59	
Dimensions (HxWxD)	mm	1750 x 600 x 210		1750 x 600 x 210		1750 x 600 x 390		1750 x 600 x 390		1750 x 600 x 390	
Weight	kg	44		45		59		59		59	

C: cooling mode  
H: heating mode

LIGHT COMMERCIAL

# RAV-DXC STANDARD DX KIT



Enables the connection of a third-party air handling unit (with DX coil) to Toshiba LC outdoor units.

### Global

- Compatible with the majority of air handling units with a DX coil fitted inside (capacity ranges from 2.5 to 27kW).
- Can operate in both heating and cooling modes, depending on end user requirements.

### Control

- Control achieved using a standard Toshiba remote controller.
- Algorithm based on air suction temperature.

### Easy to install

- Capacity set by DN code adjustment during installation.
- Extended 5 meters sensor leads pre-fitted to improve installation time and flexibility.
- Relay isolated inputs to prevent accidental wiring errors, damaging the PCB.



MAX AIR FLOW



Up to **5000**m<sup>3</sup>/h

CAPACITY



**5kW > 27kW**

OPERATION



**-27°C > +52°C**

Input/output signal available:

- Operation output,
- AC fan motor output,
- Alarm output,
- External On/Off input,
- Safety-cut output.

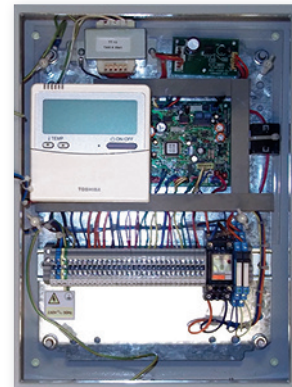

**INDOOR UNITS**

RAV-DXC010

**SDI**



**OUTDOOR UNITS**

RAV-GP561ATP-E  
RAV-GP801AT-E  
RAV-GP1101AT(8)-E  
RAV-GP1401AT(8)-E  
RAV-GP1601AT8-E

**BIG DI**



RAV-GM2241AT8-E  
RAV-GM2801AT8-E



**REMOTE CONTROLS**

RBC-AMTU31-E

## STANDARD DX KIT

### STANDARD DX KIT Performances

DX Controller unit	RAV-	DXC010	DXC010	DXC010	DXC010	DXC010	DXC010	DXC010
Outdoor Unit Cooling Capacity RANGE		2 HP	3 HP	4 HP	5 HP	6 HP	8 HP	10 HP
	Big DI							
	SDI	RAV-GP561ATP-E	RAV-GP801AT-E	RAV-GP1101AT(8)-E	RAV-GP1401AT(8)-E	RAV-GP1601AT8-E	RAV-GM2241AT8-E	RAV-GM2801AT8-E
Cooling capacity (min-max)	kW	1.2 - 5.6	1.9 - 8.0	3.1 - 12.0	3.1 - 14.0	2.6 - 16	4.6 - 22.4	4.6 - 27.0
Heating capacity (min-max)	kW	0.9 - 8.1	1.3 - 11.3	2.6 - 13	2.6 - 16.5	2.4 - 19	4.6 - 25.0	4.6 - 31.5
Standard air volume	m³/h	900	1320	1600	2100	2620	3600	4200
Coil Internal Volume (min-max)	dm³	0.8 - 1.1	1.0 - 1.4	1.5 - 2.1	1.7 - 2.7	2.0 - 3.2	3.0 - 4.2	3.6 - 5.4

### STANDARD DX KIT Physical Data

DX Controller unit	RAV-	DXC010
Dimensions (HxWxD)	mm	400 x 300 x 150
Weight	kg	8
Operating range - Cooling coil "Air on" temp	°C	15°CWB+24°CWB
Operating range - Heating coil "Air on" temp	°C	5°CDB+28°CDB
Power supply	V-ph-Hz	220/240-1-50

C: cooling mode  
H: heating mode

Cooling and heating output figures are based on calculations and "general" test data. All figures are to be taken as approximations. The properties of the third party DX Coil will have an affect on the performance of the outdoor units.

All capacity data shown is based on the following Rated Conditions:

- Cooling (Rated): Indoor air temperature 27°C db / 19°C wb, Outdoor air temperature 35°C db
- Heating (Rated): Indoor air temperature 20°C db, Outdoor air temperature 7°C db / 6°C wb.

#### Notes:

#### Cooling Mode Coil "Air On" Temp: Minimum 15°CWB (18°CDB) / Maximum 24°CWB (32°CDB)

Air temperatures flowing across the coil below this level, can in some circumstances, cause icing and freezing issues with the coil and eventually forcing the system to shut down and also be detrimental to the outdoor unit itself.

#### Heating Mode Coil "Air On" Temp: Minimum 15°CDB / Maximum 28°CDB

In the reserve cycle mode when the outdoor unit is producing hot gas, the coil in the AHU is effectively the condenser. Air temperatures flowing across the coil below this level, can cause over condensing of the refrigerant.

This can result in liquid being returned to the compressor which will cause a mechanical failure of the outdoor unit.

Low air temperatures will also cause the unit to use it's defrost mode more often.

#### Fresh Air Intake

If you wish to use Fresh Air which in outside of these Coil "Air On" limits it has to either be pre-conditioned by other equipment, or mixed with return air (or a combination of both) so that it remains inside these limits, in order to ensure reliable operation.

#### Automatic Mode

Please be aware that frequent mode changes could occur when using Automatic mode.

#### TA sensor

The TA sensor should be positioned in the return air duct. In case, it's not representative enough of the occupants area temperature, remote temperature sensor TCB -TC21LE2 should be used in the room.



RAV-DXC  
0/10V DX KIT



Enables connection and control of Toshiba LC outdoor units to a third-party air handling unit (with DX coil).

**Global**

- Compatible with the majority of air handling units with a DX coil fitted inside (capacity ranges from 2.5 to 27kW)

**Control**

- Capacity control and selection mode of the Toshiba outdoor unit directly from the AHU controller through a 0/10v signal.

**Easy to install**

- Capacity set by DN code during installation.
- Extended 5 meters sensor leads pre-fitted to improve installation time and flexibility.



MAX AIR FLOW



Up to  
5.200m<sup>3</sup>/h

CAPACITY



5kW > 27kW

OPERATION



-27°C > +52°C

Compatible with both LC and VRF systems.  
(made possible via simple switch change on PCB)

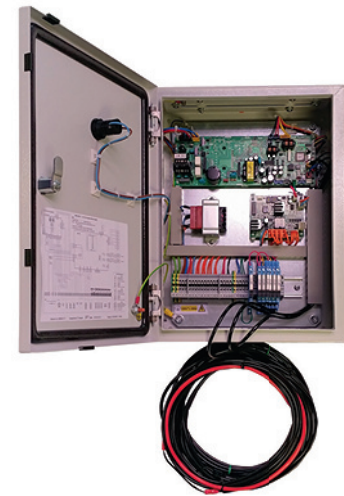

INDOOR UNITS

RAV-DXC031

SDI



OUTDOOR UNITS

RAV-GP561ATP-E  
RAV-GP801AT-E  
RAV-GP1101AT(8)-E  
RAV-GP1401AT(8)-E  
RAV-GP1601AT8-E

BIG DI



RAV-GM2241AT8-E  
RAV-GM2801AT8-E



REMOTE CONTROLS

RBC-AMTU31-E

**0/10V DX KIT**
**0/10V DX KIT Performance data**

DX Controller unit	RAV-	DXC010	DXC010	DXC010	DXC010	DXC010	DXC010	DXC010
Outdoor Unit		2 HP	3 HP	4 HP	5 HP	6 HP	8 HP	10 HP
Cooling Capacity RANGE	Big DI						RAV-GM2241AT8-E	RAV-GM2801AT8-E
	SDI	RAV-GP561ATP-E	RAV-GP801AT-E	RAV-GP1101AT(8)-E	RAV-GP1401AT(8)-E	RAV-GP1601AT8-E		
Cooling capacity (min-max)	kW	1.2 - 5.6	1.9 - 8.0	3.1 - 12.0	3.1 - 14.0	2.6 - 16	4.6 - 22.4	4.6 - 27.0
Heating capacity (min-max)	kW	0.9 - 8.1	1.3 - 11.3	2.6 - 13	2.6 - 16.5	2.4 - 19	4.6 - 25.0	4.6 - 31.5
Standard air volume	m <sup>3</sup> /h	900	1320	1600	2100	2620	3600	4200
Coil Internal Volume (min-max)	dm <sup>3</sup>	0.8 - 1.1	1.0 - 1.4	1.5 - 2.1	1.7 - 2.7	2.0 - 3.2	3.0 - 4.2	3.6 - 5.4

**0/10V DX KIT Physical Data**

LC / VRF DX Coil Controller Unit	RBC-	DXC031
Dimensions (HxWxD)	mm	400 x 300 x 150
Weight	kg	8
Standard Rating	IP	65
Operating temperature/humidity	°C / RH	5-40 / 10-90
Operating range - Cooling coil "Air on" temp	°C	15°CWB±24°CWB
Operating range - Heating coil "Air on" temp	°C	5°CDB±28°CDB
Power supply		Supplied from Outdoor unit

SDI - DI - Dig DI  
TWIN +



Connect 4 indoors units on the same system to satisfy the cooling and heating requirements of larger area.

**Comfort**

- Precise air flow control, accurately controls the distribution of the air regardless of the room size.

**Adaptability**

- Twin, triple or double twin configurations.
- Compatible with every type of LC indoor units: 4-way cassette, duct, high-wall ceiling and floor standing.

**Control**

- One user-friendly controller for all the indoor units to simplify the control.



SCOP MAX



5.05

CAPACITY



9.5kW > 27kW

OPERATION



-27°C > +52°C

Toshiba RAV simplistic piping design allows multiple indoor units to be connected via a simple branching methodology.

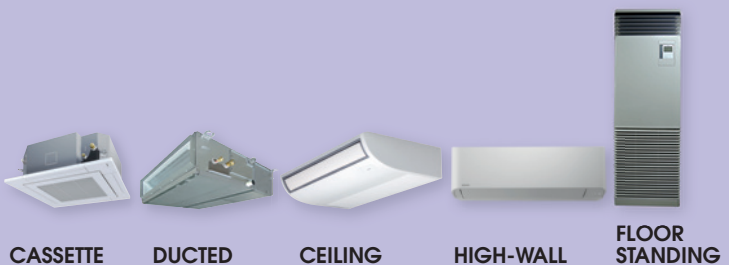
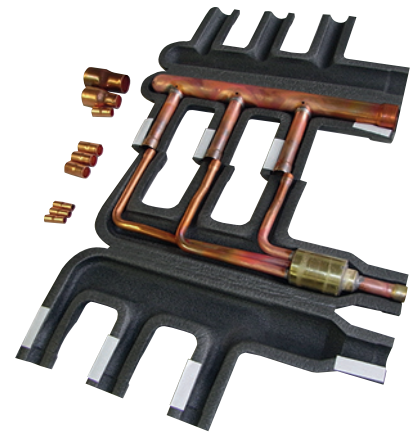

CASSETTE    DUCTED    CEILING    HIGH-WALL    FLOOR STANDING

RAV-HM\_UTP-E/TR   RAV-HM\_BTP-E/TR   RAV-HM\_CTP-E/TR   RAV-HM\_KRTP-E/TR   RAV-HM\_FT-E/TR  
RAV-HM\_MUT-E/TR   RAV-HM\_SDTY-E/TR  
RAV-HM\_UTTP-E



OUTDOOR UNITS

RAV-GP1101AT(8)-E/TR   RAV-GM1101AT(8)P-E/TR   RAV-GM2241AT8-E1/TR1  
RAV-GP1401AT(8)-E/TR   RAV-GM1401AT(8)P-E/TR   RAV-GM2801AT8-E1/TR1  
RAV-GP1601AT8-E/TR   RAV-GM1601AT(8)P-E/TR



REMOTE CONTROLS

RBC-AWSU52-E  
RBC-AMSU52-E  
RBC-AMTU31-E  
RBC-ASCU11-E

## SYSTEM OVERVIEW

### TWIN SYSTEM - 2 indoor units connected

#### Outdoor unit

Digital Inverter 4/5 HP  
or  
Super Digital Inverter 3/4/5/6 HP  
or  
Big Digital Inverter 8/10 HP

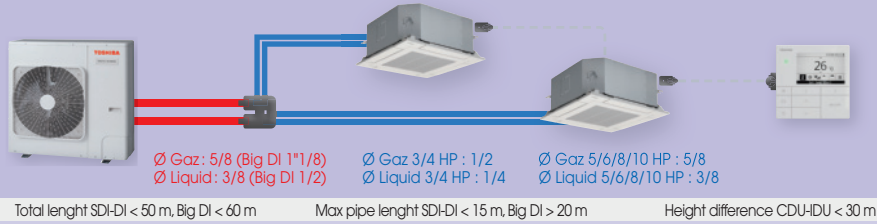

#### Remote

RBC-AMSU52-E

### TRIPLE SYSTEM - 3 indoor units connected

#### Outdoor unit

Super Digital Inverter 6 HP  
or  
BIG Digital Inverter 8/10 HP

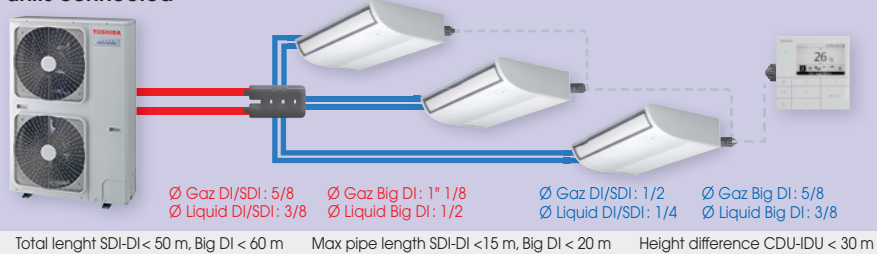

#### Remote

RBC-AMSU52-E

### W-TWIN SYSTEM - 4 indoor units connected

#### Outdoor unit

Big Digital Inverter 8/10 HP

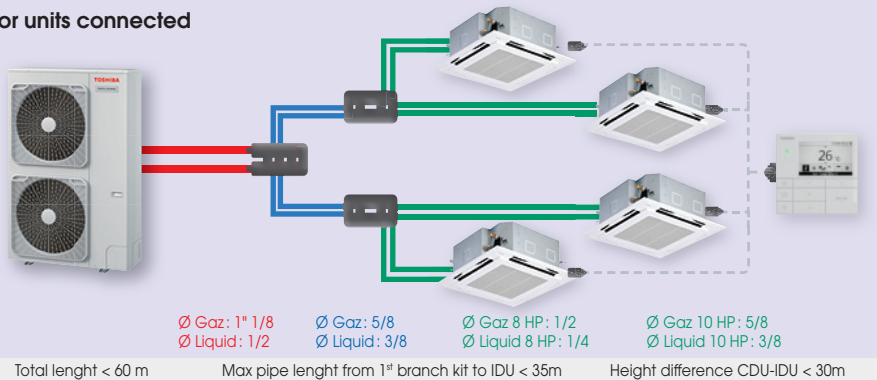

#### Remote

RBC-AMSU52-E

## TWIN SDI

### Cooling & heating

Indoor unit model	Outdoor unit RAV-	Indoor unit RAV-	HP	Cooling capacity nin. - nominal - max kW	Heating capacity nin. - nominal - max kW	EER	SEER	COP	SCOP	Energy class
Smart 4-way cassette	GP1101AT-E/TR	HM561UT-E/TR	4	3.1 - 10.0 - 12.0	2.6 - 11.2 - 13.0	5.26	9.15	5.14	5.03	A+++/A++
	GP1401AT-E1/TR	HM801UT-E/TR	5	3.1 - 12.5 - 14.0	2.6 - 14 - 16.5	4.30	8.79	4.61	5.00	-/-
4-way cassette	GP1101AT-E/TR	HM561UTP-E/TR	4	3.1 - 10.0 - 12.0	2.6 - 11.2 - 13.0	4.69	8.57	4.79	4.73	A++/A++
	GP1401AT-E1/TR	HM801UTP-E/TR	5	3.1 - 12.5 - 14.0	2.6 - 14.0 - 16.5	3.96	8.14	4.36	4.72	-/-
	GP1101AT8-E/TR	HM561UTP-E/TR	4	2.6 - 10.0 - 12.0	2.4 - 11.2 - 15.6	4.31	7.06	4.65	4.36	A++/A+
	GP1401AT8-E/TR	HM801UTP-E/TR	5	2.6 - 12.5 - 14.0	2.4 - 14.0 - 18.0	3.65	7.06	4.11	4.36	-/-
	GP1601AT8-E/TR	HM801UTP-E/TR	6	2.6 - 14.0 - 16.0	2.4 - 16.0 - 19.0	3.23	6.76	3.74	4.36	-/-
Compact 4way cassette	GP801AT-E/TR	HM401MUT-E/TR	3	1.9 - 7.1 - 8.0	1.3 - 8.0 - 11.3	4.10	7.91	4.40	4.87	A++/A++
	GP1101AT-E/TR	HM561MUT-E/TR	4	3.1 - 10.0 - 12.0	2.6 - 11.2 - 13.0	4.18	7.93	4.19	4.42	A++/A+
	GP1101AT8-E/TR	HM561MUT-E/TR	4	2.6 - 10.0 - 12.0	2.4 - 11.2 - 14.0	3.85	6.32	3.74	3.94	A++/A
	GP1101AT-E1/TR	HM561BTP-E/TR	4	3.1 - 10.0 - 12.0	2.6 - 11.2 - 13.0	4.17	6.74	4.10	4.26	A++/A+
Ducted	GP1401AT-E1/TR	HM801BTP-E/TR	5	3.1 - 12.5 - 14.0	2.6 - 14.0 - 16.5	3.50	6.27	3.86	4.25	-/-
	GP1101AT8-E/TR	HM561BTP-E/TR	4	2.6 - 10.0 - 12.0	2.4 - 11.2 - 15.6	3.88	5.81	4.06	4.16	A+/A
	GP1401AT8-E/TR	HM801BTP-E/TR	5	2.6 - 12.5 - 14.0	2.4 - 14.0 - 18.0	3.28	5.64	3.83	3.96	-/-
	GP1601AT8-E/TR	HM801BTP-E/TR	6	2.6 - 14.0 - 16.0	2.4 - 16.0 - 19.0	3.12	5.50	3.50	3.94	-/-
Slim duct	GP801AT-E/TR	RM401SDT-E/TR	3	1.9 - 7.1 - 8.0	1.3 - 8.0 - 11.3	3.80	6.5	4.40	4.51	A++/A+
	GP1101AT-E/TR	RM561SDT-E/TR	4	3.1 - 10.0 - 12.0	2.6 - 11.2 - 13.0	3.91	6.65	4.19	4.00	A++/A+
	GP1101AT8-E/TR	RM561SDT-E/TR	4	2.6 - 10.0 - 12.0	2.4 - 11.2 - 14.0	3.60	5.60	4.21	3.84	A+/A
Ceiling	GP801AT-E/TR	HM401CTP-E/TR	3	1.9 - 7.1 - 8.0	1.3 - 8.0 - 11.3	4.44	7.82	4.44	5.05	A++/A++
	GP1101AT-E/TR	HM561CTP-E/TR	4	3.1 - 10.0 - 12.0	2.6 - 11.2 - 13.0	4.48	7.97	4.71	4.71	A++/A++
	GP1401AT-E1/TR	HM801CTP-E/TR	5	3.1 - 12.5 - 14.0	2.6 - 14.0 - 16.5	3.49	7.34	3.90	4.7	-/-
	GP1101AT8-E/TR	HM561CTP-E/TR	4	2.6 - 10.0 - 12.0	2.4 - 11.2 - 14.0	3.91	6.54	4.46	4.21	A++/A+
	GP1401AT8-E/TR	HM801CTP-E/TR	5	2.6 - 12.5 - 14.0	2.4 - 14.0 - 18.0	3.40	6.17	4.02	4.19	-/-
	GP1601AT8-E/TR	HM801CTP-E/TR	6	2.6 - 14.0 - 16.0	2.4 - 16.0 - 19.0	3.04	5.89	3.72	4.19	-/-
Floor standing	GP1101AT-E/TR	HM561FT-E/TR	4	3.1 - 10.0 - 12.0	2.6 - 11.2 - 13	4.18	6.84	4.06	4.40	A++/A+
	GP1401AT-E1/TR	HM801FT-E/TR	5	3.1 - 12.5 - 14	2.6 - 14 - 16.5	3.55	6.47	3.53	4.38	-/-
	GP1101AT8-E/TR	HM561FT-E/TR	4	2.6 - 10 - 12	2.4 - 11.2 - 14	4.07	6.02	4.04	4.02	A+/A+
	GP1401AT8-E/TR	HM801FT-E/TR	5	2.6 - 12.5 - 14	2.4 - 14 - 18	3.46	6.01	3.67	4.02	-/-
	GP1601AT8-E/TR	HM801FT-E/TR	6	2.6 - 14 - 16	2.4 - 16 - 19	3.19	5.81	3.31	3.98	-/-
	GP1101AT-E/TR	HM561KRTP-E/TR	4	3.1 - 10 - 12	2.6 - 11.2 - 13	4.1	8.15	4.1	4.05	A++/A+
High-wall	GP1401AT-E1/TR	HM801KRTP-E/TR	5	3.1 - 12.5 - 14	2.6 - 14 - 16.5	3.45	6.69	3.66	4.37	-/-
	GP1101AT8-E/TR	HM561KRTP-E/TR	4	2.6 - 10.0 - 12.0	2.4 - 11.2 - 14.0	3.83	6.35	4.21	4.14	A++/A+
	GP1401AT8-E/TR	HM801KRTP-E/TR	5	2.6 - 12.3 - 13.5	2.4 - 14.0 - 18.0	3.30	6.10	3.70	4.11	-/-
	GP1601AT8-E/TR	HM801KRTP-E/TR	6	2.6 - 14.0 - 16.0	2.4 - 16.0 - 19.0	3.01	5.88	3.29	4.08	-/-



# TRIPLE SDI



## Cooling & heating

Indoor unit model	Outdoor unit RAV-	Indoor unit RAV-	HP	Cooling capacity nin. - nominal - max kW	Heating capacity nin. - nominal - max kW	EER	SEER	COP	SCOP	Energy class
4-way cassette	GP1601AT8-E/TR	HM561UTP-E/TR	6	2.6 - 14.0 - 16.0	2.4 - 16.0 - 19.0	3.23	6.71	3.74	4.36	-/-
Compact 4-way cassette	GP1601AT8-E/TR	HM561MUT-E/TR	6	2.6 - 14.0 - 16.0	2.4 - 16.0 - 19.0	3.30	6.32	3.51	4.15	-/-
Ducted	GP1601AT8-E/TR	HM561BTP-E/TR	6	2.6 - 14.0 - 16.0	2.4 - 16.0 - 19.0	3.12	5.43	3.5	3.94	-/-
Slim duct	GP1601AT8-E/TR	HM561SDT-E/TR	6	2.6 - 14.0 - 16.0	2.4 - 16.0 - 19.0	2.91	5.98	3.5	4.07	-/-
Ceiling	GP1601AT8-E/TR	HM561CTP-E/TR	6	2.6 - 14.0 - 16.0	2.4 - 16.0 - 19.0	3.04	5.95	3.72	4.19	-/-
High-wall	GP1601AT8-E/TR	HM561KRTP-E/TR	6	2.6 - 14.0 - 16.0	2.4 - 14.0 - 19.0	3.19	5.75	3.31	3.98	-/-
Floor standing	GP1601AT8-E/TR	HM561FT-E/TR	6	2.6 - 14.0 - 16.0	2.4 - 16.0 - 19.0	3.19	5.55	3.31	3.96	-/-

# TWIN DI



## Cooling & heating

Indoor unit model	Outdoor unit RAV-	Indoor unit RAV-	HP	Cooling capacity nin. - nominal - max kW	Heating capacity nin. - nominal - max kW	EER	SEER	COP	SCOP	Energy class
4-way cassette	GM1102ATW-E	HM561UTP-E	4	3 - 9.5 - 11.2	3 - 11.2 - 13	3.7	7.38	3.92	4.4	A++/A+
	GM1102AT8W-E	HM561UTP-E	4	3 - 9.5 - 11.2	3 - 11.2 - 13	3.76	7.03	3.97	4.29	-/A+
	GM1402ATW-E	HM801UTP-E	5	3 - 12.1 - 13.2	3 - 13 - 16	3.12	7.25	3.79	4.4	-/-
	GM1402AT8W-E	HM801UTP-E	5	3 - 12.1 - 13.2	3 - 13 - 16	3.17	6.86	3.83	4.3	-/-
	GM1602ATW-E	HM801UTP-E	6	3 - 14 - 15	3 - 16 - 17	2.77	6.56	3.39	4.4	-/-
Compact 4-way cassette	GM1602AT8W-E	HM801UTP-E	6	3 - 14 - 15	3 - 16 - 18	2.84	6.49	3.44	4.38	A++/-
	GM1102ATW-E	HM561MUT-E	4	3 - 9.5 - 11.2	3 - 11.2 - 13	3.52	6.7	3.55	4.1	A++/A+
	GM1102AT8W-E	HM561MUT-E	4	3 - 9.5 - 11.2	3 - 11.2 - 13	3.58	6.17	3.6	4.06	A++/A+
	GM1102ATW-E	HM561BTP-E	4	3 - 9.5 - 11.2	3 - 11.2 - 13	3.65	6.3	3.85	4	A+/A+
	GM1102AT8W-E	HM561BTP-E	4	3 - 9.5 - 11.2	3 - 11.2 - 13	3.71	5.91	3.9	3.92	-/A
Ducted	GM1402ATW-E	HM801BTP-E	5	3 - 12.1 - 13.2	3 - 13 - 16	3.02	6.1	3.66	3.92	-/-
	GM1402AT8W-E	HM801BTP-E	5	3 - 12.1 - 13.2	3 - 13 - 16	3.07	5.83	3.71	3.84	-/-
	GM1602ATW-E	HM801BTP-E	6	3 - 14 - 15	3 - 16 - 17	2.66	5.86	3.38	4.05	-/-
	GM1602AT8W-E	HM801BTP-E	6	3 - 14 - 15	3 - 16 - 18	2.72	5.76	3.43	3.96	A+/-
	GM1102ATW-E	HM561SDTY-E	4	3 - 9.5 - 11.2	3 - 11.2 - 13	3.50	6.04	3.61	3.91	A+/A
Slim duct	GM1102AT8W-E	HM561SDTY-E	4	3 - 9.5 - 11.2	3 - 11.2 - 13	3.50	5.63	3.61	3.90	-/A
	GM1602ATW-E	HM801SDTY-E	6	3 - 14 - 15	3 - 16 - 17	2.63	5.15	2.83	3.84	-/-
	GM1602AT8W-E	HM801SDTY-E	6	3 - 14 - 15	3 - 16 - 18	2.63	5.04	2.83	3.76	A++/-
	GM1102ATW-E	HM561CTP-E	4	3 - 9.5 - 11.2	3 - 11.2 - 13	3.67	6.89	3.91	4.3	A++/A+
	GM1102AT8W-E	HM561CTP-E	4	3 - 9.5 - 11.2	3 - 11.2 - 13	3.72	6.37	3.95	4.29	-/A+
Ceiling	GM1402ATW-E	HM801CTP-E	5	3 - 12.1 - 13.2	3 - 13 - 16	3.02	6.11	3.74	4.28	-/-
	GM1402AT8W-E	HM801CTP-E	5	3 - 12.1 - 13.2	3 - 13 - 16	3.07	5.83	3.79	4.2	-/-
	GM1602ATW-E	HM801CTP-E	6	3 - 14 - 15	3 - 16 - 17	2.78	6.21	3.77	4.3	-/-
	GM1602AT8W-E	HM801CTP-E	6	3 - 14 - 15	3 - 16 - 18	2.83	6.08	3.41	4.22	A++/-
	GM1102ATW-E	HM561KRTP-E	4	3 - 9.5 - 11.2	3 - 11.2 - 13	3.21	6.3	3.26	4.2	A+/A+
High-wall	GM1102AT8W-E	HM561KRTP-E	4	3 - 9.5 - 11.2	3 - 11.2 - 13	3.22	6.01	3.31	4.19	-/A+
	GM1402ATW-E	HM801KRTP-E	5	3 - 12.1 - 13.2	3 - 13 - 16	2.88	5.97	2.9	4.2	-/-
	GM1402AT8W-E	HM801KRTP-E	5	3 - 12.1 - 13.2	3 - 13 - 16	2.93	5.65	2.94	4.19	-/-
	GM1602ATW-E	HM801KRTP-E	6	3 - 14 - 15	3 - 16 - 17	2.57	5.66	2.58	4.2	-/-
	GM1602AT8W-E	HM801KRTP-E	6	3 - 14 - 15	3 - 16 - 18	2.62	5.56	2.63	4.16	A++/-
Floor standing	GM1102ATW-E	HM561FT-E	4	3 - 9.5 - 11.2	3 - 11.2 - 13	3.5	6.1	3.61	3.92	A+/A
	GM1102AT8W-E	HM561FT-E	4	3 - 9.5 - 11.2	3 - 11.2 - 13	3.55	5.77	3.64	3.92	-/A
	GM1402ATW-E	HM801FT-E	5	3 - 12.1 - 13.2	3 - 13 - 16	2.8	5.46	3.29	3.9	-/-
	GM1402AT8W-E	HM801FT-E	5	3 - 12.1 - 13.2	3 - 13 - 16	2.85	5.29	3.34	3.9	-/-
	GM1602ATW-E	HM801FT-E	6	3 - 14 - 15	3 - 16 - 17	2.63	5.15	2.83	3.9	-/-
GM1602AT8W-E	HM801FT-E	6	3 - 14 - 15	3 - 16 - 18	2.68	5.09	2.83	3.82	-/-	

# TRIPLE DI



## Cooling & heating

Indoor unit model	Outdoor unit RAV-	Indoor unit RAV-	HP	Cooling capacity nin. - nominal - max kW	Heating capacity nin. - nominal - max kW	EER	SEER	COP	SCOP	Energy class
4-way cassette	GM1602ATW-E	HM561UTP-E	6	3 - 14 - 15	3 - 16 - 17	2.77	6.51	3.39	4.4	-/-
Compact 4-way cassette	GM1602ATW-E	HM561MUT-E	6	3 - 14 - 15	3 - 16 - 17	2.55	5.46	2.63	4.09	-/-
Ducted	GM1602ATW-E	HM561BTP-E	6	3 - 14 - 15	3 - 16 - 17	2.66	5.83	3.38	4.05	-/-
Slim duct	GM1602ATW-E	HM561SDTY-E	6	3 - 14 - 15	3 - 16 - 17	2.63	5.1	2.83	3.84	-/-
Ceiling	GM1602ATW-E	HM561CTP-E	6	3 - 14 - 15	3 - 16 - 17	2.78	6.18	3.37	4.3	-/-
Floor standing	GM1602ATW-E	HM561FT-E	6	3 - 14 - 15	3 - 16 - 17	2.63	5.1	2.83	3.9	-/-
High-wall	GM1602ATW-E	HM561KRTP-E	6	3 - 14 - 15	3 - 16 - 17	2.57	5.63	2.58	4.19	-/-
4-way cassette	GM1602AT8W-E	HM561UTP-E	6	3 - 14 - 15	3 - 16 - 18	2.84	6.44	3.44	4.38	-/-
Compact 4-way cassette	GM1602AT8W-E	HM561MUT-E	6	3 - 14 - 15	3 - 16 - 18	2.6	5.37	2.68	4.06	-/-
Ducted	GM1602AT8W-E	HM561BTP-E	6	3 - 14 - 15	3 - 16 - 18	2.72	5.73	3.43	3.96	-/-
Slim duct	GM1602AT8W-E	HM561SDTY-E	6	3 - 14 - 15	3 - 16 - 18	2.63	4.99	2.83	3.75	-/-
Ceiling	GM1602AT8W-E	HM561CTP-E	6	3 - 14 - 15	3 - 16 - 18	2.83	6.05	3.41	4.22	-/-
Floor standing	GM1602AT8W-E	HM561FT-E	6	3 - 14 - 15	3 - 16 - 18	2.68	5.05	2.83	3.82	-/-
High-wall	GM1602AT8W-E	HM561KRTP-E	6	3 - 14 - 15	3 - 16 - 18	2.62	5.53	2.63	4.16	-/-

**TWIN BIG DI**



**Cooling & heating**

Indoor unit model	Outdoor unit	Indoor unit	HP	Cooling capacity			Heating capacity			EER	SEER	COP	SCOP	Energy class
				nin.	nominal	max	nin.	nominal	max					
	RAV-	RAV-		kW			kW							
4-way cassette	GM2241AT8-E1/TR1	HM1101UTP-E/TR	8	4.6	20.0	22.4	4.6	22.4	25.0	3.6	6.53	4.23	4.05	-/-
	GM2801AT8-E1/TR1	HM1401UTP-E/TR	10	4.6	23.5	27.0	4.6	27.0	31.5	3	6.21	3.8	3.9	-/-
Ducted	GM2241AT8-E1/TR1	HM1101BTP-E/TR	8	4.6	20.0	22.4	4.6	22.4	25.0	3.24	5.03	4.02	3.72	-/-
	GM2801AT8-E1/TR1	HM1401BTP-E/TR	10	4.6	23.5	27.0	4.6	27.0	31.5	2.65	5	3.62	3.64	-/-
Ceiling	GM2241AT8-E1/TR1	HM1101CTP-E/TR	8	4.6	20.0	25.0	4.6	22.4	25.0	3.24	5.67	3.92	3.79	-/-
	GM2801AT8-E1/TR1	HM1401CTP-E/TR	10	4.6	23.5	27.0	4.6	27.0	31.5	2.62	5.16	3.57	3.65	-/-
Floor standing	GM2241AT8-E1/TR1	HM1101FT-E/TR	8	4.6	20.0	25.0	4.6	22.4	25.0	3.24	5.42	3.28	3.62	-/-
	GM2801AT8-E1/TR1	HM1401FT-E/TR	10	4.6	23.5	27.0	4.6	27.0	31.5	2.65	5.20	3.83	3.59	-/-

**TRIPLE BIG DI**



**Cooling & heating**

Indoor unit model	Outdoor unit	Indoor unit	HP	Cooling capacity			Heating capacity			EER	SEER	COP	SCOP	Energy class
				nin.	nominal	max	nin.	nominal	max					
	RAV-	RAV-		kW			kW							
4-way cassette	GM2241AT8-E1/TR1	HM801UTP-E/TR	8	4.6	20.0	22.4	4.6	22.4	25.0	3.60	6.57	4.23	4.05	-/-
	GM2801AT8-E1/TR1	HM801UTP-E/TR	10	4.6	23.5	27.0	4.6	27.0	31.5	3.00	6.24	3.80	3.91	-/-
Ducted	GM2241AT8-E1/TR1	HM801BTP-E/TR	8	4.6	20.0	22.4	4.6	22.4	25.0	3.24	5.23	4.02	3.73	-/-
	GM2801AT8-E1/TR1	HM801BTP-E/TR	10	4.6	23.5	27.0	4.6	27.0	31.5	2.65	5.18	3.62	3.65	-/-
Ceiling	GM2241AT8-E1/TR1	HM801CTP-E/TR	8	4.6	20.0	25.0	4.6	22.4	25.0	3.24	5.59	3.92	3.79	-/-
	GM2801AT8-E1/TR1	HM801CTP-E/TR	10	4.6	23.5	27.0	4.6	27.0	31.5	2.62	5.16	3.57	3.65	-/-
High-wall	GM2241AT8-E1/TR1	HM-801KRTP-E/TR	8	4.6	20.0	22.4	4.6	22.4	25.0	3.00	5.58	3.66	3.76	-/-
	GM2801AT8-E1/TR1	HM-801KRTP-E/TR	10	4.6	23.5	27.0	4.6	27.0	31.5	2.55	5.30	3.53	3.63	-/-
Floor standing	GM2241AT8-E1/TR1	HM801FT-E/TR	8	4.6	20.0	22.4	4.6	22.4	25.0	3.24	5.36	3.98	3.62	-/-
	GM2801AT8-E1/TR1	HM801FT-E/TR	10	4.6	23.5	27.0	4.6	27.0	31.5	2.65	5.15	3.29	3.59	-/-

LIGHT COMMERCIAL

**DOUBLE TWIN BIG DI**



**Cooling & heating**

Indoor unit model	Outdoor unit	Indoor unit	HP	Cooling capacity			Heating capacity			EER	SEER	COP	SCOP	Energy class
				nin.	nominal	max	nin.	nominal	max					
	RAV-	RAV-		kW			kW							
4-way cassette	GM2241AT8-E1/TR1	HM561UTP-E/TR	8	9.8	20.0	22.4	9.8	22.4	25.0	3.60	6.57	4.23	4.05	-/-
	GM2801AT8-E1/TR1	HM801UTP-E/TR	10	9.8	23.0	27.0	9.8	27.0	31.5	3.00	6.16	3.80	3.90	-/-
Compact 4-way cassette	GM2241AT8-E1/TR1	HM561MUT-E/TR	8	4.6	20.0	22.4	4.6	22.4	25.0	3.15	6.24	3.66	4.24	-/-
Ducted	GM2241AT8-E1/TR1	HM561BTP-E/TR	8	4.6	20.0	25.0	4.6	22.4	25.0	3.24	5.18	4.02	3.73	-/-
	GM2801AT8-E1/TR1	HM801BTP-E/TR	10	4.6	23.5	27.0	4.6	27.0	31.5	2.65	5.12	3.62	3.65	-/-
Slim duct	GM2241AT8-E1/TR1	HM561SDT-E/TR	8	4.6	20.0	22.4	4.6	22.4	25.0	3.00	5.44	3.66	3.86	-/-
	GM2241AT8-E1/TR1	HM561CTP-E/TR	8	4.6	20.0	22.4	4.6	22.4	25.0	3.24	5.68	3.92	3.79	-/-
Ceiling	GM2801AT8-E1/TR1	HM801CTP-E/TR	10	4.6	23.5	27.0	4.6	27.0	31.5	2.62	5.06	3.57	3.65	-/-
	GM2241AT8-E1/TR1	HM561KRTP-E/TR	8	4.6	20.0	22.4	4.6	22.4	25.0	3.00	5.60	3.66	3.76	-/-
High-wall	GM2801AT8-E1/TR1	HM801KRTP-E/TR	10	4.6	23.5	27.0	4.6	27.0	31.5	2.55	5.22	3.53	3.62	-/-
	GM2241AT8-E1/TR1	HM561FT-E/TR	8	4.6	20.0	25.0	4.6	22.4	25.0	3.24	5.32	3.98	3.61	-/-
Floor standing	GM2801AT8-E1/TR1	HM801FT-E/TR	10	4.6	23.5	27.0	4.6	27.0	31.5	2.65	5.12	3.29	3.59	-/-



ON YOUR OWN AS A FAMILY

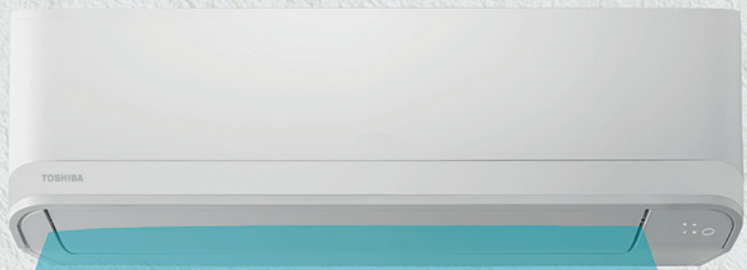

IN A GROUP ON



### Take control of your comfort !

Toshiba offers various control solutions to meet users' and designers' expectations. From local individual control and settings to computer-based TCC link/TU2C link networks, all indoor units can be programmed and set to suit your operational needs. Remote control systems offer a wide range of features including schedule timers, diagnostic functions, power meters and input/output signals, to name just a few. Toshiba VRF units are compatible with industry standards and can be connected to all the main building management software systems in use. TCC link is Toshiba's dedicated Central Control Network which can be used with VRF and light commercial units either directly or by means of a specially-designed network adapter.





# > CONTROLS

YOUR OWN AS A FAMILY IN A GROUP ON YOUR OWN







RAV/VRF  
**INDIVIDUAL REMOTE CONTROLLER**

> **INFRARED REMOTE CONTROLLER**

One remote compatible with every LC/VRF indoor units



Included with bi-flow console and LC/VRF high wall

- Easy to use remote controller with direct access to every function
- In addition of standard function, HI power, Quiet and Comfort sleep mode
- 2 steps timer mode



RBC-AX41U(W)-E

- Smart cassette panel corner receiver



RBC-AXU33UP-E & RBC-AXU33PB-E

- Standard cassette panel corner receiver (available in white or black)



RBC-AX33UYP-E

- 1 way cassette panel corner receiver (compatible with YHP 1-way cassette)



RBC-AXU31UM-E

- Panel corner receiver (compatible with compact 4-Way cassette)



RBC-AX31UC-E

- Ceiling panel receiver



RBC-AXU31-E

- Stand alone receiver (compatible with all indoor units)

> **WIRED REMOTE CONTROLLER**

One solution for every projects



RBC-ASCU11-E

Back to basics with this new remote offering all the standard functionalities with compact dimensions and large screen.

**Functions:**

On/Off, operation mode, temperature setting, fan speed, louvres fault codes & unit setup.



RBC-AMTU31-E

The standard remote to control an individual indoor unit or a group of 8 indoor units

**Functions:**

On/Off, operation mode, temperature setting, fan speed, louvres, fault codes, unit setup and button restrictions



RBC-AMSU52-E

> **NEW**

The ultimate in local remote controller with built-in 7-Day timer, large screen and menu

**Functions:**

On/Off, operation mode, dual set point, fan speed, louvres, return back, energy savings, frost protection, auto summer/winter clock, soft cooling, leak detection, fault codes, unit setup and button restrictions

> **WIRED REMOTE CONTROLLER WITH BLUETOOTH CAPABILITY**

New control mindset

> **NEW**



RBC-AWSU52-E

- Enjoy a greater control experience with the wired remote controller RBC-AWSU52-E that offers an optimised user interface and advanced installer-oriented functionalities.
- With Bluetooth connectivity, easily manage comfort through smartphones using the Wave Commu Control app.

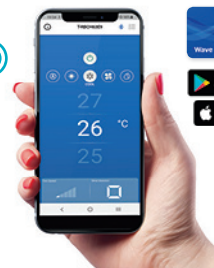

Toshiba Home  
**AC CONTROL**

> DO YOU WANT A SMART SOLUTION TO GIVE YOUR FAMILY GREATER COMFORT WHILST EASILY MANAGING YOUR ENERGY SAVINGS?

● **MULTIPLE UNITS, ONE APP**

- 1 user can control up to 10 AC units
- 1 AC unit can be controlled by up to 5 users

● **EASY GROUPING**

- Make control simple by grouping your AC units in up to 3 zones

● **SECURE CONNECTIONS**

- Password & login
- Child lock function

● **COMPATIBLE PRODUCTS**

- DAISEIKAI 9, SHORAI, Console, SEIYA. (Jan'19)

● **DOWNLOAD YOUR APP**

- Toshiba AC Control App for your Android and iOS smartphone from Google Play or the App Store



Take complete control of your comfort with the Toshiba Home AC Control App. Simple to use on your smartphone or tablet, both at home and on the move. Fully compatible, the adapter can be used with all Toshiba High-walls and Console units.

**Enhance your comfort, at home or away**

Customise your comfort, finding the perfect cooling or heating level for your family at any time, no matter where you are. When at home, simply replace your infrared remote control with the intuitive smart app. This also gives you easy access to your air conditioner on the move, allowing you to adapt your comfort to your lifestyle!



**Smart & efficient**

- Want to go home and immediately enjoy an ideal temperature? Simply use the app to check the status, quickly and easily, adjust your comfort, no matter where you are.
- Match your AC schedule to your family's routine to optimise running time, and enjoy savings on your energy bill.

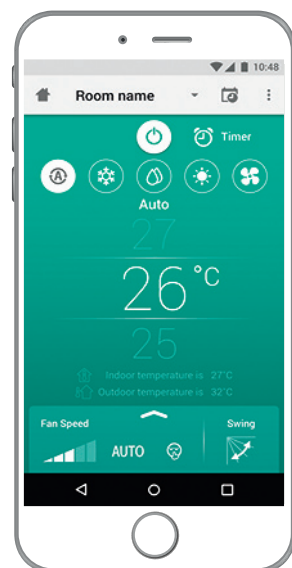

**Modern app**

- This user-friendly app is available in 5 languages, and boasts a host of intuitive features. With a different colour for each different mode, and the main functions accessible in just one touch.
- Toshiba premium features enable you to enjoy all the benefits of your AC systems at home. Simply swipe up on the main app screen on your smartphone or tablet to access additional Toshiba-specific features.

**FLOOR**

- 8°C** Holiday frost protection mode
- HiPOWER** Boost mode
- FLOOR** Floor function for Consoles
- PURE** Plasma & ionizer filters
- FLOOR** Silent CDU to reduce the outdoor unit noise level

Toshiba  
**HOME AC CONTROL**

> DO YOU WANT FULL CONTROL OF YOUR AC SYSTEM IN ONE TOUCH, WHEREVER YOU ARE?

Toshiba Home Ac control is now compatible with light commercial and VRF indoor units. Get access to main control features via an Android or iOS smartphone.

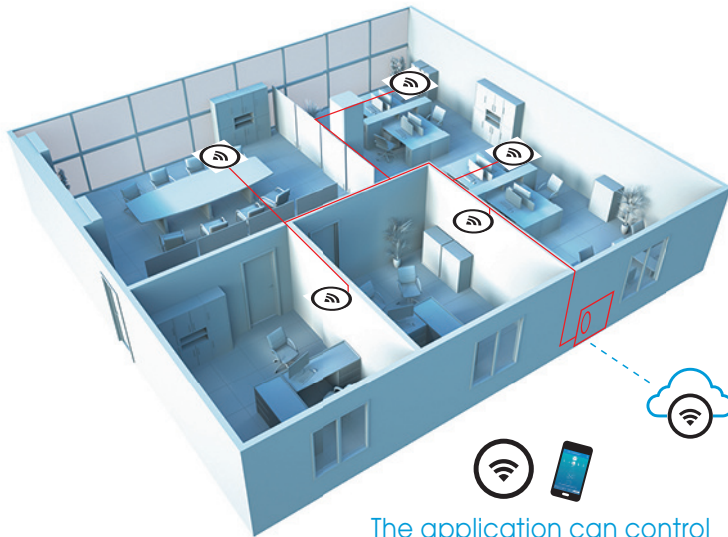

The application can control up to 16 indoor units

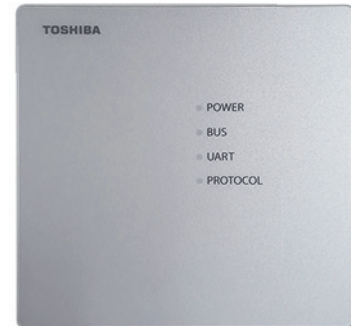

BMS-IWF0010UCP-E,  
1 module is needed per indoor unit

**Solutions wherever you are**

Toshiba technology you can trust, fully committed to providing creative building management solutions, designed to enhance your sustainable lifestyle.

**Make it your own**

1 unit is manageable by a maximum of 5 users. For enhanced security, a user name and password is needed to log in.

**Everything you need in one app**

All of the indoor unit's functions can be accessed in an instant, allowing you to enjoy the full advantages of the AC system at work. The entire system is simple to manage, even remotely.

● **QUICK AND EASY**

- Simplified installation with **direct connection to the remote controller port (AB port).**

● **DESIGNED FOR YOU**

- **Up to 5 users** to control one indoor unit.
- **Login and password** required for high access security level.

● **EVERYTHING UNDER CONTROL**

- **Optimize the management** of spaces like offices or meeting rooms without compromising comfort.

● **COMPATIBLE PRODUCTS**

- RAV light commercial solutions, MiNi-SMMS, MiNi SMMS-e, SMMS-u, SHRM-e & SHRM Advance.

● **DOWNLOAD YOUR APP**

- Toshiba home AC Control App for your Android and iOS smartphone from Google Play or the App Store.

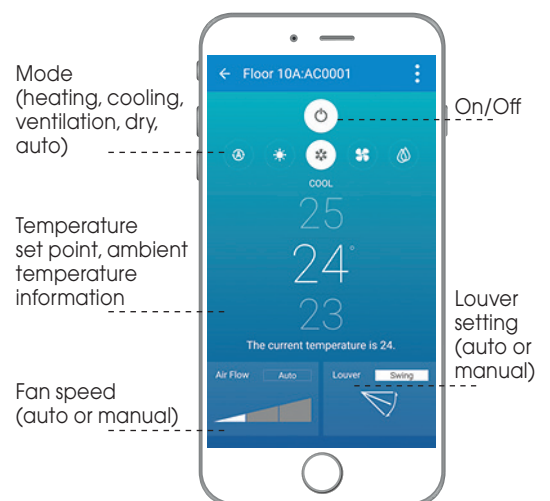

CONTROLS



# A2W/RAV/VRF CENTRAL CONTROL

## > UP TO 64 INDOOR UNITS

### 64 central controller



TCB-SC640U-E

64 central controller is now able to control Estia R32 products.

- Full control of max 64 LC & VRF indoor units + Estia R32 air to water systems
- Individual indoor unit, group (up to 10 groups) or full installation control
- Simple and intuitive interface with user friendly menus
- Large backlight display
- Touch-sensitive keys
- Standard features (On/Off, mode, temperature setting, fan speed, louvers)
- + permit/prohibit functions + Estia R32 functions accessibility
- Embedded digital outputs
- Compatible with TCC link and TU2C Link

## > UP TO 256 INDOOR UNITS

### Touch Screen Smart Manager

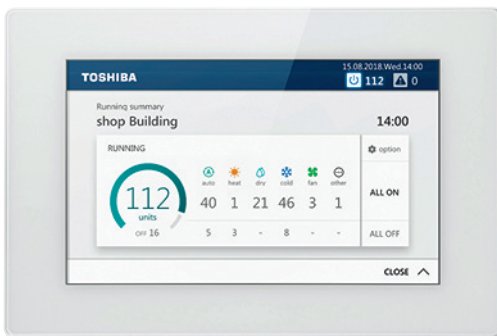

BMS-CT2560U-E

- Full control of max 256 indoor units
- 7" color touchscreen
- Nice looking menu with intuitive navigation to enhance control experience
- Advanced scheduling of indoor and outdoor units to maximize comfort & save energy
- Energy monitoring with or without power meter thanks to Data Analyser software
- Webserver to keep control in any circumstances
- Embedded input and output to enlarge control or interact with other equipment
- Dedicated fault code menu with Email transfer capability
- Compatible with TCC link & TU2C link



### RAC interface - specifications

**> NEW**



TCB-SRRL011UUP-E

- Control RAS systems using centralized remote controller.
- Advanced RAS features accessible using BMS-CT2560U-E Touch Screen or TCB-IFMB1280U-E Modbus gateway.

Model name	TCB-SRRL011UUP-E	
Dimensions	WxLxH	mm 28x120x120
Max connection	Interface to RAS	1 by 1 connection
	Interface to BMS	Max 256 interfaces
Wiring	Interface to RAS	UART port
	Interface to BMS	TU2C link U <sub>h</sub> or TCC Link U3U4
Net weight	kg	0.14
Operation temperature	°C	0 to 50°C
Power input	From indoor unit through UART port	
Power consumption	W	0.22
Body material	ABS (UL94-BH compliant)	

## > UP TO 512 INDOOR UNITS

### Centralized Touch Screen Controller



BMS-CT5121E

- Full control of max 512 indoor units: on/off, mode, set point, fan speed, louver management and prohibit mode
- 12.1 large screens
- Quick and accurate view of indoor unit status through dedicated logo
- Floor, building, tenant and system overview with possibility to integrate plan
- Built in web server for control through web browser
- Weekly timer with up to 20 steps per day
- Energy monitoring with graph, to view operating hours, set point, inside/outside temperature, and power consumption
- Email alert in case of troubles
- Compatible with TCC link



> Additional  
PCB

> DEDICATED TO OUTDOOR UNITS

Outdoor units advanced functions

> POWER PEAK CUT CONTROL BOARD SENSOR

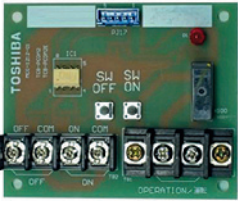

TCB-PCDM4E

- Limits capacity of the VRF outdoor unit at 85%, 80%, 75% and 60% load or stop it.
- Compatible with all VRF outdoor units.

> CONTROL OPERATION BOARD SENSOR



TCB-PCIN4E

- Error/Individual compressor operation output control board.
- Compatible with all VRF outdoor units.

> EXTERNAL MASTER ON/OFF CONTROL SENSOR



TCB-PCMO4E

- External master On/Off control board, night mode and mode priority selection.
- Compatible with all VRF outdoor units.

> APPLICATION CONTROL SENSOR KIT



TCB-PCOS1E2

- Enables night operation control, demand control and operation monitoring.
- Compatible with DI.

> DEDICATED FOR INDOOR UNITS

Indoor units advanced functions

> WINDOWS SWITCH SENSOR

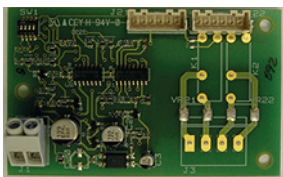

TCB-IFCB5PE

- Ensures the indoor unit not operate when outside window is open or for door entry systems.
- RAS, RAV and VRF indoor units.

> OPTIONAL CONNECTION KIT



TCB-PCUC2E

- Extends control capability of light commercial and VRF indoor units with third party equipment.
- Compatible with RAV and VRF indoor units.

> MULTI-TENANT



TCB-PSMT1E

- For multi tenant application, this PCB maintains low voltage power supply during tenant absence when the main power supply for the FCU is shut down.
- Compatible with VRF indoor units.

> TCC LINK INTERFACE



TCB-PCNT30TLE2

- Allows DI/SDI indoor units & AHU DX kits to be connected to TCC link network.

## > RAV/VRF/ESTIA GATEWAY

### > MODBUS® RTU

#### Reliable and easy to use



TCB-IFMB1280U-E

Directly connect up to 128 Toshiba Air Conditioning indoor units to a Modbus® Building Management System. Maximum 15 Modbus I/F can be connected per Modbus Master Device. Compatible with TCC Link & TU2C Link protocols.

#### Individual gateway



BMS-IFMB0UCW-E (RAV/VRF)  
BMS-IFMB0UEW-E (Estia)

Connect easily one indoor unit or a group of 8 indoor units to a Modbus Building Management Control System.

### > LONWORKS®

#### 12 input network variables



TCB-IFLN642TLE

Directly connect up to 64 Toshiba Air Conditioning indoor units and up to 16 outdoor units to a Lonworks® Building Management Control System. Compatible with RBC-WP1-PE Lonworks Control software.

### > KNX®

#### ETS configuration



TO-AC-KNX-64 (RAV/VRF - TCC Link)  
TO-AC-KNX-16 (RAV/VRF - TCC Link)  
BMS-IFKX0UCW-E (RAV/VRF)  
BMS-IFKX0UEW-E (Estia)

Directly connect up to 64, 16 or only one Toshiba Air Conditioning indoor units to a KNX® Building Management Control System.

### > BACNET® IP

#### Standard gateway



BMS-IFBN1281U-E  
(Estia R32, SMMS-u & SHRM-Advance compatibility)

Directly connect up to 128 Toshiba Air Conditioning indoor units to a BACnet® Building management Control System.

Network adaptor TCB-PCNT30TLE2 required for connection of DI/SDI Indoor Units (1 per Master Indoor Unit)

## > RAV/VRF INTERFACES

### > ANALOGUE INTERFACE

#### Analogue 0/10V control



TCB-IFCB640TLE

The Analogue Relay Interface is a device that can be connected directly to the TCC-Link Central Control network to provide Analogue & Digital Inputs & Outputs for control over Toshiba Air Conditioner products from non-Toshiba control systems.

### > GENERAL PURPOSE RELAY INTERFACE

#### Toshiba equipment control



TCB-IFCG1TLE

The General Purpose Relay Interface is a device that can be connected directly to the TCC-Link Central Control Network and addressed on the TCC-Link Network in order to provide control of non-Toshiba equipment from a Toshiba control system, and control of the Toshiba Air Conditioner from Digital & Analogue Inputs.

### > GSM INTERFACE

#### Control any time anywhere...



TCB-IFGSM1E

The TCB-IFGSM1E Interface is a device that allows control of the Toshiba Air Conditioning Equipment from a remote location using standard GSM (Global system for Mobile communications) Mobile phone SMS text messages.

# LIGHT COMMERCIAL ACCESSORIES

Indoor unit type	Parts name	Model name	Comply with	Notes	Remarks
Smart 4-way cassette	Standard panel	RBC-U41PG(W)-E	RAV-HM***UT-E	Required accessory	Use with TCB-GFC1603UE
	Motion Sensor	TCB-SIR41U-E			
	Fresh air and filter chamber	TCB-GFC1603UE		For fresh air inlet box	
	Fresh air inlet box	TCB-GB1602UE		For fresh air intake by using the knockout hole of Fresh air and filter chamber. (dia.=100 mm)	
	Auxiliary fresh air flange	TCB-FF101URE2		For easy fresh air intake by using the knockout hole of indoor unit. (dia.=100mm) height 50 mm	
	Spacer for height adjustment	TCB-SP1603UE		Air direction change by cutting off air discharge port (3 pcs.)	
4-way cassette	Air discharge direction kit	TCB-BC1603UE	RAV-HM***UTP-E	White color	lonizer + dust filter + dust sensor + remote lonizer + dust filter + remote
	Smart panel	RBC-U33P-E		Before pre filter	
	Motion Sensor	RBC-U33PB-E		After pre filter	
	Air purifier kit	TCB-EAPC1UHP-E TCB-EABC1UHP-E		For easy fresh air intake by using the knockout hole of indoor unit. (dia.=100mm)	
	PM2.5 filters	TCB-PLFC1UPE-120 TCB-PLFC2UPE-80		Required accessory	
	Auxiliary fresh air flange	TCB-FF101URE2		Wireless remote controller kit (RBC-AX32UM(W)-E) and Occupancy sensor cannot be used on the same indoor unit	
Compact 4-way cassette	Standard panel	RBC-UM21PG(W)-E	RAV-HM***MUT-E	For easy fresh air intake by using the knockout hole of indoor unit. (dia.=100mm)	
	Motion Sensor	TCB-SIR41UM-E			
1-way cassette	Auxiliary fresh air flange	TCB-FF101URE2	RAV-HM***U1TP-E		
	Panel	RBC-UY32P-E			
	Air purifier kit	TCB-EAPC1UHP-E			
Slim duct	Motion Sensor	TCB-SIR41UYP-E	RAV-HM***SDTY-E	For easy fresh air intake by using the knockout hole of indoor unit. (dia.=100mm)	
	Auxiliary fresh air flange	TCB-FF101URE2			
Concealed duct	Spigot shaped flange	TCB-SF56C6BE TCB-SF80C6BE TCB-SF160C6BE	RAV-HM401BTP-E to RAV-HM561BTP-E RAV-HM801BTP-E RAV-HM1**1BTP-E		
	Auxiliary fresh air flange	TCB-FF101US-E	RAV-HM***BTP-E	For easy fresh air intake by using the knockout hole of indoor unit. (dia.=100mm)	
	Long life filter kit	TCB-LK2801DP-E			
Concealed Duct high static pressure	Drain Pump kit	TCB-DP40DPE	RAV-GM***DTP-E		Use TCB-KP13, 23CE
	Auxiliary fresh air flange	TCB-FF101US-E		For easy fresh air intake by using the knockout hole of indoor unit. (dia.=100mm) Lift up to 600 mm	
Ceiling-suspended	Drain pump kit	TCB-DP31CE	RAV-HM***1CTP-E		
	Elbow Piping Kit	TCB-KP14CPE TCB-KP24CPE	RAV-HM401CTP & RAV-HM561CTP-E RAV-HM801CTP-E & RAV-HM1**1CTP-E	Needed when drain pump kit is used	
	Auxiliary fresh air flange	TCB-FF101URE2	RAV-HM***1CTP-E	For easy fresh air intake by using the knockout hole of indoor unit. (dia.=100mm)	
High wall	Ultra Pure filter	818F0050	RAV-HM***K RTP-E	2 filters per high wall	
Floor standing	Remote controller cover kit	TCB-CKC1F-E	RAV-HM***FT-E		Needed when remote is installed inside the floor standing

Code	Description	Capacities
RBC-TWP30E2	Twin-branch kit for DI & SDI	1.5 HP + 1.5 HP 2 HP + 2 HP
RBC-TWP50E2	Twin-branch kit for DI & SDI	3 HP + 3 HP 4 HP + 4 HP
RBC-TWP101E	Twin-branch kit for BigDI	5 HP + 5 HP
RBC-TRP100E	Triple-branch kit for DI & Big DI	2 HP + 2 HP + 2 HP 3 HP + 3 HP + 3 HP
RBC-DTWP101E	Double-twin branch kit fir Big DI	2 HP + 2 HP + 2 HP + 2HP 3 HP + 3 HP + 3 HP + 3HP

### Air filtration solutions

For standard 4-way cassette



#### TCB-EAPC1UHP-E

Air Purifier kit with Ionizer, dust indicator, IR and adapted remote. Can be merged with PM2.5 filter.

For High Wall



#### 818F0050

Ultra pure filter set.

For 1-way cassette



#### TCB-EAPC1UHP-E

Air purifier kit with plasma, dust indicator, IR and adapted remote.



# TOSHIBA



## *Better Air Solutions*

Through our commitment to world-class **efficiency**, versatile **scalability** and leading **quality**, Toshiba Air Conditioning advances leading-edge technologies to find the most forward-thinking solutions possible for your world.

DYSTRYBUTOR:

**TK THERMO  
KOMFORT**

Systemy HVACR

[www.thermokomfort.pl](http://www.thermokomfort.pl)

tel. 505 034 537

e-mail: [biuro@thermokomfort.pl](mailto:biuro@thermokomfort.pl)